

---

**\*TM 9 - 345**

**RESTRICTED**

**TECHNICAL MANUAL }  
No. 9-345 }**

**WAR DEPARTMENT  
Washington, July 15, 1942**

**155-MM GUN MATERIEL, M1917, M1918  
AND MODIFICATIONS**

**Prepared  
under the direction of the  
Chief of Ordnance**



**RESTRICTED**

**TECHNICAL MANUAL }  
No. 9-345 }**

**WAR DEPARTMENT  
Washington, July 15, 1942**

**155-MM GUN MATERIEL, M1917, M1918  
AND MODIFICATIONS**

**Prepared  
under the direction of the  
Chief of Ordnance**

**TABLE OF CONTENTS**

<b>Section</b>	<b>Paragraphs</b>	<b>Pages</b>
<b>I: Introduction .....</b>	<b>1-4</b>	<b>3-10</b>
<b>II: Description and functioning of gun.....</b>	<b>5-12</b>	<b>11-24</b>
<b>III: Description and functioning of carriage..</b>	<b>13-26</b>	<b>25-48</b>
<b>IV: Description and functioning of limber...</b>	<b>27-36</b>	<b>49-58</b>
<b>V: Operation .....</b>	<b>37-47</b>	<b>59-78</b>
<b>VI: Care and preservation.....</b>	<b>48-60</b>	<b>79-103</b>
<b>VII: Painting .....</b>	<b>61-66</b>	<b>104-106</b>
<b>VIII: Inspection and adjustment.....</b>	<b>67-69</b>	<b>107-113</b>
<b>IX: Malfunction and correction.....</b>	<b>70-74</b>	<b>114-120</b>
<b>X: Disassembly and assembly.....</b>	<b>75-91</b>	<b>121-143</b>
<b>XI: Sighting equipment .....</b>	<b>92-100</b>	<b>144-161</b>
<b>XII: Fire-control equipment .....</b>	<b>101-106</b>	<b>162-182</b>
<b>XIII: Ammunition .....</b>	<b>107-120</b>	<b>183-204</b>
<b>XIV: Subcaliber equipment .....</b>	<b>121-137</b>	<b>205-220</b>
<b>XV: Organization spare parts and accessories</b>	<b>138-139</b>	<b>221-226</b>
<b>XVI: Storage, packing, shipment.....</b>	<b>140-143</b>	<b>227-232</b>
<b>XVII: Operation under unusual conditions....</b>	<b>144-148</b>	<b>233-235</b>
<b>XVIII: Materiel affected by gas.....</b>	<b>149-151</b>	<b>236-238</b>
<b>XIX: References .....</b>	<b>152-154</b>	<b>239-241</b>
<b>Index: .....</b>		<b>242-246</b>

*\*This manual supersedes TM 9-345, November 1, 1941; TR 1305-155c. March 10, 1931, including C1, January 2, 1933; C2, January 2, 1934; and C3, January 2, 1936.*

155-MM GUN MATERIEL, M1917, M1918 AND MODIFICATIONS

RA PD 37564

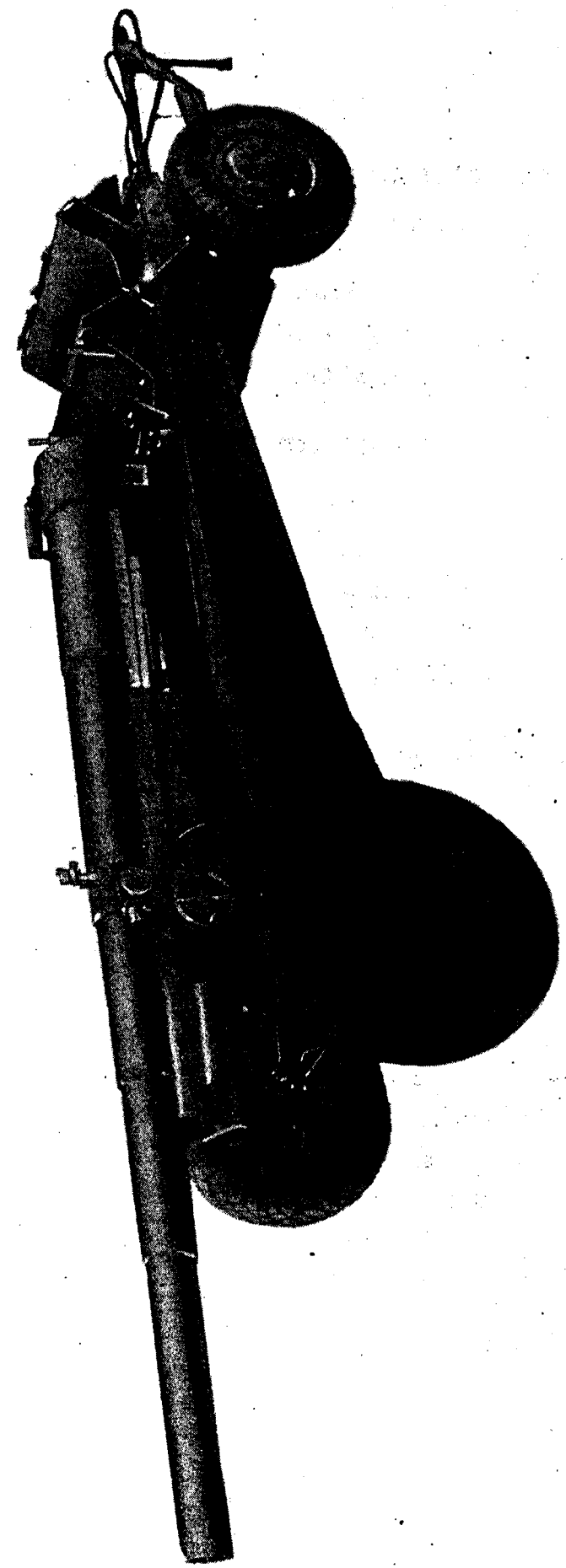

Figure 1—Right side of the 155-mm gun, M1917A1, the 155-mm gun carriage, M2, and the heavy carriage limber, M3, in traveling position

TIONS

Section I  
INTRODUCTION

	Paragraph
Purpose and scope .....	1
Characteristics .....	2
Differences among models .....	3
Tabulated data .....	4

1. PURPOSE AND SCOPE

a. This manual is published for the information of the using arms and services.

b. In addition to a description of the 155-mm guns, M1917, M1917A1 and M1918MI; the 155-mm gun carriages, M1917, M1918, M1917A1, M1918A1, M2 and M3; the 155-mm gun carriage limbers, M1917, M1918, M1917A1 and M1918A1; and the heavy carriage limber, M3, this manual contains technical information required for the identification, use, and care of the materiel.

c. Disassembly, assembly, and such repairs as may be handled by the using arms personnel will be undertaken only under the supervision of an officer or the chief mechanic.

d. In all cases where the nature of the repair, modification, or adjustment is beyond the scope of the facilities of the unit, the responsible ordnance service should be informed in order that trained personnel with suitable tools and equipment may be provided, or proper instructions issued for the performance of the work.

2. CHARACTERISTICS

a. Guns. The 155-mm guns, M1917, M1917A1 and M1918MI, use separate loading ammunition and throw projectiles of approximately 95 pounds at a muzzle velocity of about 2410 feet per second a maximum distance of approximately 20,000 yards. The rate of fire, with supercharge, is four rounds per minute not to exceed 40 rounds. The shock of recoil is absorbed by a variable recoil system through which the length of recoil is shortened as the angle of elevation is increased. The gun is restored to its firing position by the counterrecoil system.

b. Carriages. The 155-mm gun carriages, M1917A1, M1918A1, M2 and M3, are modified M1917 and M1918 gun carriages. They are of the single axle, two-wheel, split-trail type. They are compact and have a low center of gravity in traveling position. The traveling speed at which they can be moved is dependent upon the modification they have received. In firing position, they have a range movement in elevation of

Figure 1—Right side of the 155-mm gun, M1917A1, the 155-mm gun carriage, M2, and the heavy carriage limber, M3, in traveling position

155-MM GUN MATERIEL, M1917, M1918 AND MODIFICATIONS

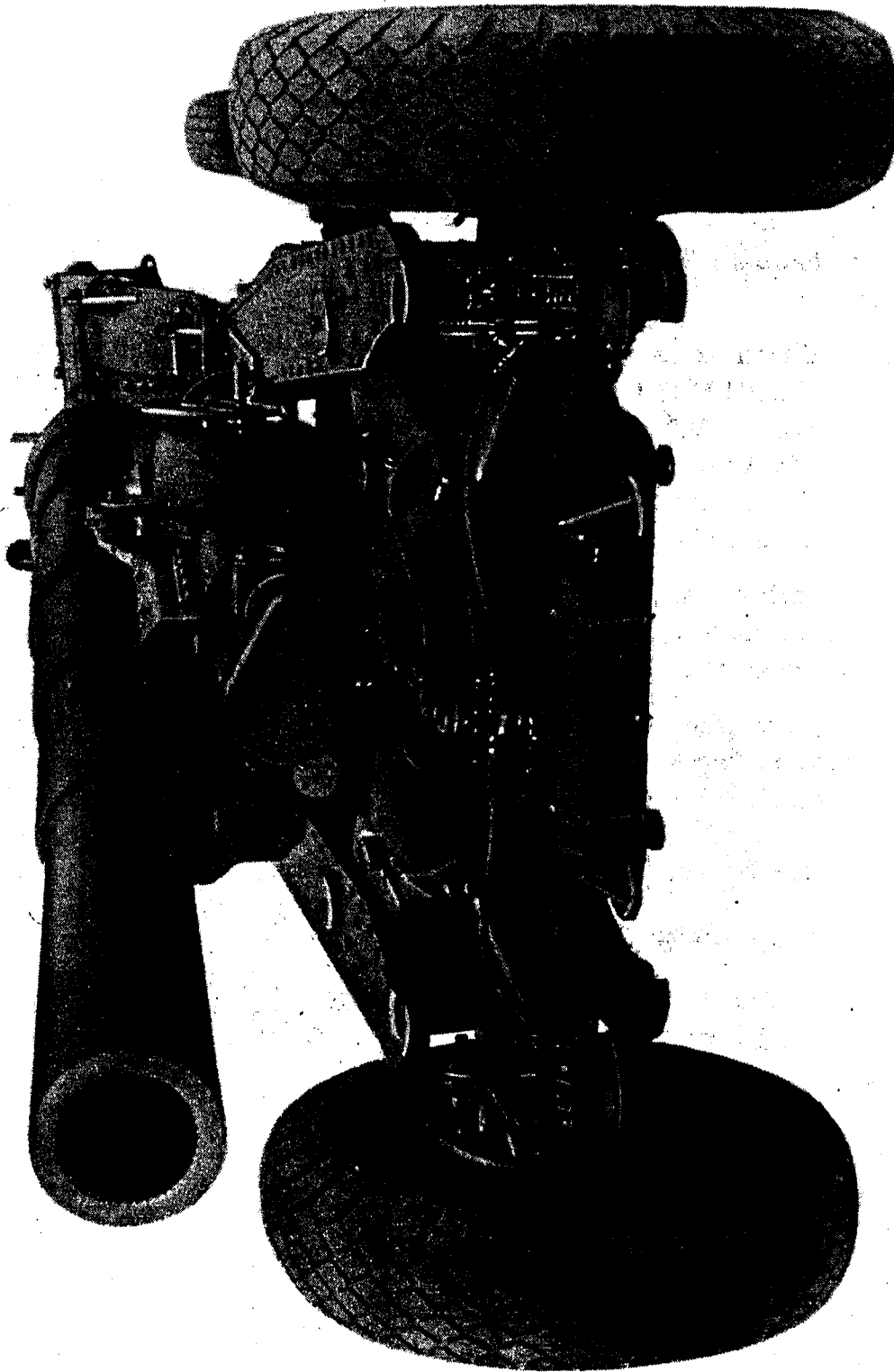

RA PD 37565

Figure 2—Muzzle end of the 155-mm gun, M1917A1, the 155-mm gun carriage, M2, and the heavy carriage limber, M3, in traveling position

TIONS

## INTRODUCTION

from 0° to 35° (622.2 mils) and a traverse range of 30° (533½ mils) to the right and left of mid-position.

c. **Limbers.** The 155-mm gun carriage limbers, M1917, M1918, M1917A1 and M1918A1, and the heavy carriage limber, M3, are all two-wheeled vehicles designed to support and secure the trails of the carriage in traveling position and to provide a coupling to the prime mover. Major differences between the various limbers and their modifications which affect steering, braking, and high speed transport are covered in paragraph 3c.

## 3. DIFFERENCES AMONG MODELS

a. **Guns.** The differences between the 155-mm guns, M1917, M1917A1, and M1918MI, as well as the means of identification of the various models are given in paragraph 5.

b. **Carriages.** (1) The 155-mm gun carriages, M1917 and M1918, were patterned after the French design "Grande Puissance Filloux" (G. P. F.). They were intended to be moved at very low speeds. They had two steel-bodied wheels carried on bronze hub liners. Each wheel was equipped with two solid rubber tires.

(2) As modified for "high speed," and designated M1917A1 and M1918A1, these carriages were equipped with electric brakes and the wheels were fitted with antifriction roller bearings.

(3) As further modified for high speed transport, and designated M2 and M3, they were equipped with steel disk wheels, heavy duty pneumatic tires and air brakes. The original semi-elliptic spring, on which the gun axle was suspended in traveling position, was eliminated.

(4) Inasmuch as the majority of the 155-mm gun carriages, M1917 and M1918, have been or will be fully modified, and inasmuch as the differences exist only in minor mechanical changes in wheels and tires, and in types of brakes, this manual will cover mainly the 155-mm gun carriages, M2 and M3. Attention will be called to points of difference which affect the using arms and services.

c. **Limbers.** (1) The 155-mm gun carriage limbers, M1917 and M1918, and their modifications, M1917A1 and M1918A1 are entirely different from the heavy carriage limber, M3. These two types of limber are alike only in that both are two-wheeled vehicles designed to serve the same purpose.

(2) The 155-mm gun carriage limbers, M1917 and M1918, have two steel-spoked wheels carried on bronze bushings and are equipped with solid rubber tires. Steering is by means of steering knuckles joined by steering rods and their universal joint couplings to the drawbar tie.

RA PD 37565  
 Figure 2—Muzzle end of the 155-mm gun, M1917A1, the 155-mm gun carriage, M2, and the heavy carriage limber, M3, in traveling position

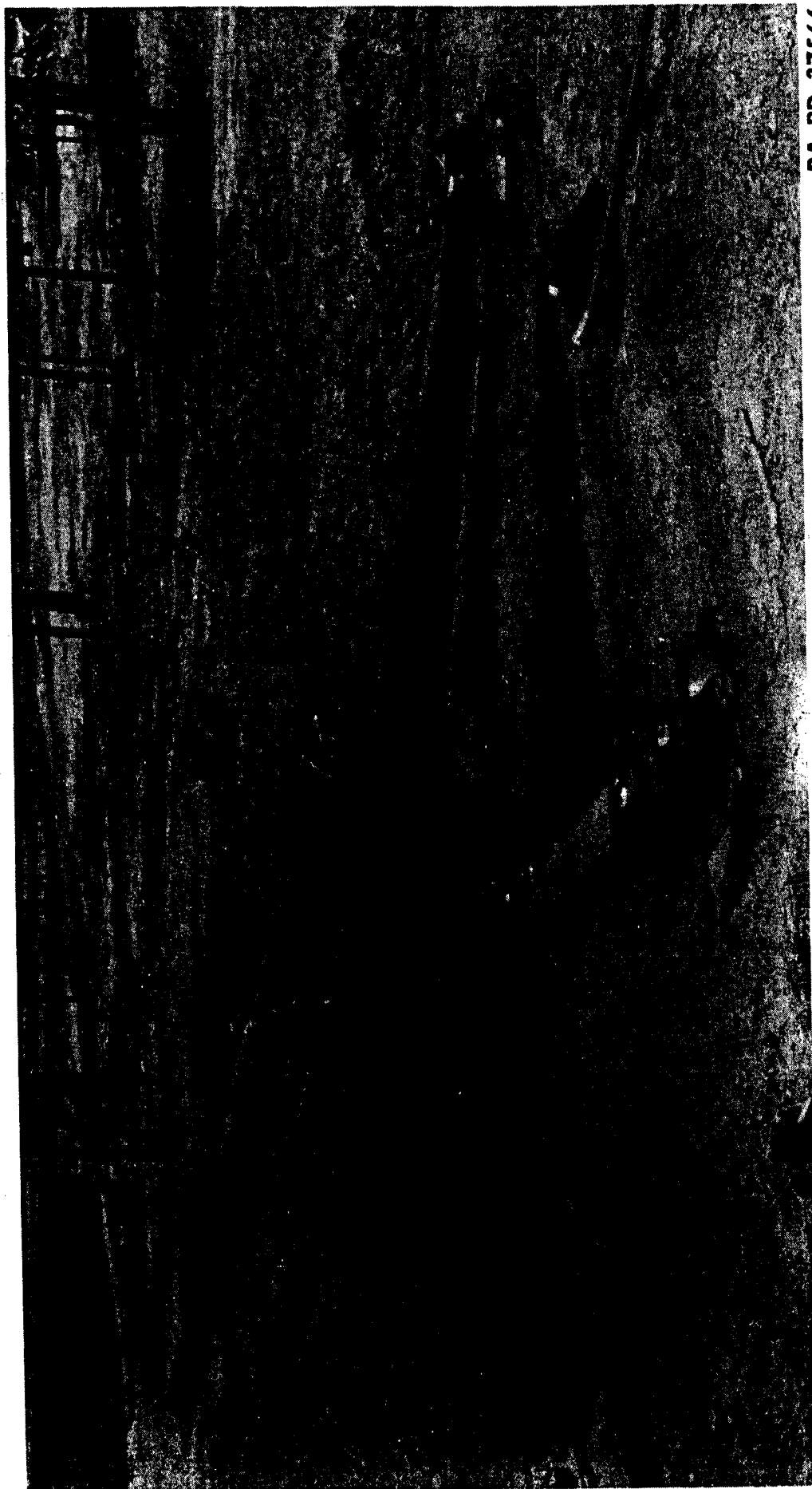

RA PD 37566

Figure 3—Left rear view of the 155-mm gun, M1917A1 and the 155-mm gun carriage, M2, in firing position



RA PD 37566

Figure 3—Left rear view of the 155-mm gun, M1917A1 and the 155-mm gun carriage, M2, in firing position

**INTRODUCTION**

As the pole-type drawbar is swung to either side, the steering knuckles are swung in the same direction and the wheels follow the movement of the drawbar. A seat is provided on the limber for the operator of the mechanical brakes who controls the carriage brakes from this point.

(3) The 155-mm gun carriage limbers, M1917A1 and M1918A1, are modifications of 155-mm gun carriage limbers, M1917 and M1918. The modifications correspond with those made in the 155-mm gun carriages, M1917A1 and M1918A1, and consist of equipping the wheels with anti-friction bearings and the removing of the brake operator's seat, due to the fact that the electric brakes on the carriage wheels are controlled from the prime mover.

(4) The heavy carriage limber, M3, has steel disk wheels and heavy duty pneumatic tires, a fifth-wheel type of steering, rigid axle and wheel spindles, and an A-shaped drawbar. It was designed for high speed movement.

**4. TABULATED DATA**

a. **General.** The weights, measurements and ballistic data given in subparagraphs b., c. and d. are approximately the same for each of the models mentioned.

b. **Weights, dimensions, and ballistics (155-mm gun, M1917, M1917A1, and M1918MI).**

Weight of 155-mm gun M1918MI, complete.....	8715 lb.
Caliber, 155-mm or.....	6.102 in.
Length (muzzle to rear face of breech ring).....	232.87 in.
<b>Chamber:</b>	
Diameter.....	6.693 in.
Length, breech closed to base of projectile.....	37.087 in.
Capacity.....	1329 cu. in.
<b>Rifling:</b>	
Number of grooves.....	48
Twist, right hand, uniform, 1 turn in 29.89 calibers (inclination 6°)	
Travel of projectile in bore.....	185 in.
Weight of projectile.....	95 lb.
Weight of full powder charge.....	25¼ lb.
Maximum powder pressure per square inch.....	31,500 lb.
Maximum range with supercharge.....	20,000 yd.

**Rate of fire (with supercharge):**

4 rounds per minute not to exceed 40 rounds.

155-MM GUN MATERIEL, M1917, M1918 AND MODIFICATIONS

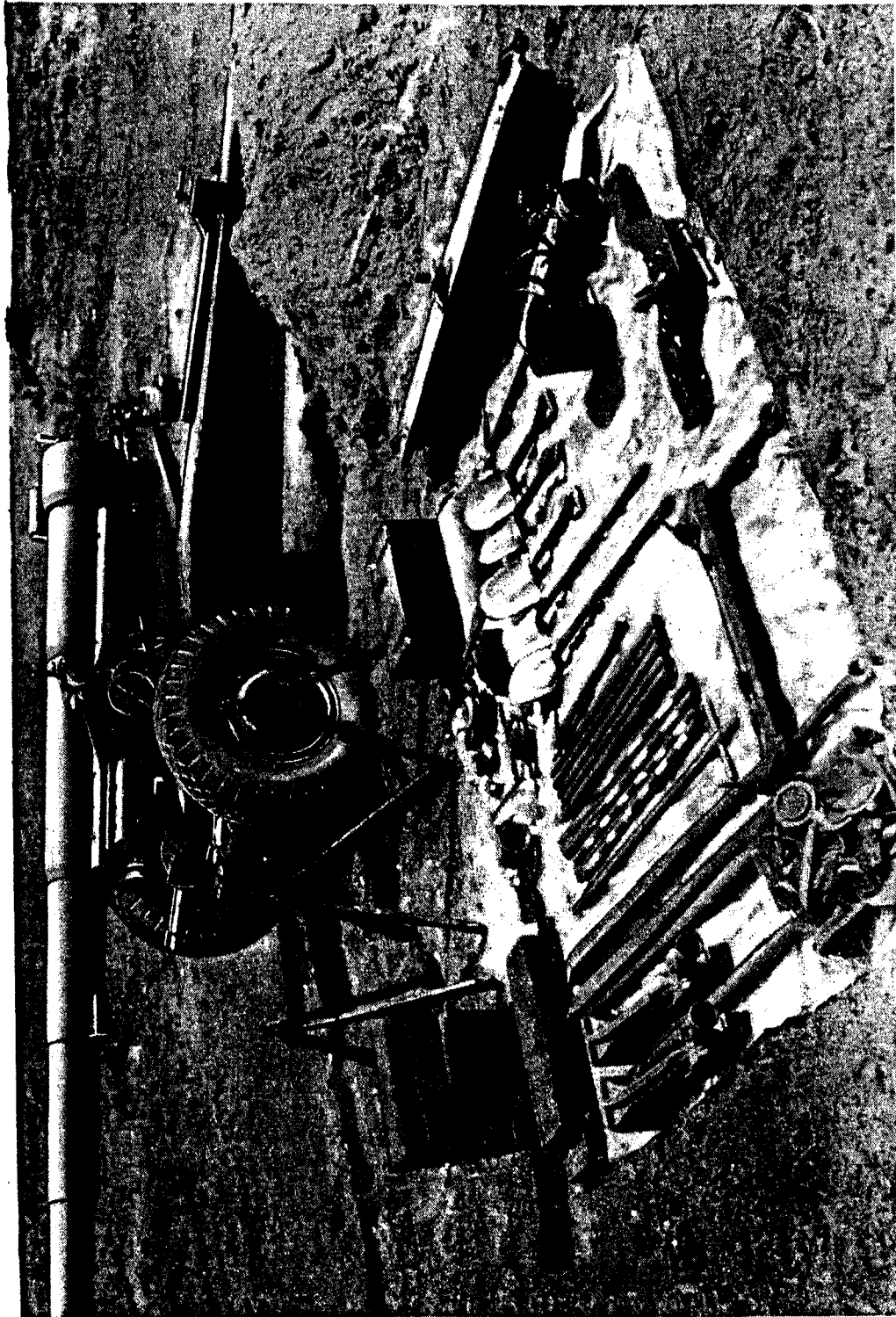

RA PD 37708

Figure 4—Left side view of the 155-mm gun, M1918M1, and the 155-mm gun carriage, M3, in firing position, with battery tools, equipment and accessories

INTRODUCTION

c. General data pertaining to 155-mm gun carriages, M1917, M1917A1, M1918, and M1918A1, and 155-mm gun carriage limbers, M1917, M1917A1, M1918, and M1918A1.

Weight of recoil mechanism with elevating sector and piston rod nuts.....	3114 lb.
Weight of panoramic telescope, 5 pounds; quadrant sight, 41 pounds.....	46 lb.
Weight of 2 large spades.....	1220 lb.
Weight of accessories carried on carriage and limber (including axle pivot pin 27½ pounds).....	35 lb.
Weight of limber chassis.....	3600 lb.
Weight of limber seat and trail clamping transom.....	245 lb.
Weight of remainder of carriage.....	10,970 lb.
Total weight, gun (8715 pounds), carriage and limber, road position, without caterpillar bands.....	27,800 lb.
Reaction at each carriage wheel (road position).....	8300 lb.
Reaction at each limber wheel (road position).....	5600 lb.
Weight of caterpillar band for one wheel.....	534 lb.
Weight of one 1160-mm dual rubber-tired wheel (average without 35-pound brake drum).....	985 lb.

Dimensions:

Width of track, center to center of wheels.....	88.58 in.
Greatest width (over hub caps).....	105.28 in.
Height of center line of bore from ground (at 0° elevation with caterpillar bands).....	54.17 in.
Caterpillar bands raise the gun approximately.....	2 in.
Height of line of sight above ground.....	69.81 in.
Height of cradle trunnions above ground.....	52 in.
Wheel base, carriage, and limber.....	14¾ ft.
Width of space required for half-turn.....	52½ ft.
Length over-all, traveling position, gun, carriage, and limber.....	28⅔ ft.
With 10-ton artillery tractor (approximately).....	42⅔ ft.

Road clearance (without caterpillar bands):

At middle of gun axle spring.....	11 in.
At ends of gun axle spring.....	8½ in.

d. General data pertaining to 155-mm gun carriages, M2 and M3, and heavy carriage limber, M3.

Weight of recoil mechanism with elevating sector and piston rod nuts.....	3114 lb.
Weight of panoramic sight, 5 pounds; quadrant sight, 41 pounds.....	46 lb.

Figure 4—Left side view of the 155-mm gun, M1918M1, and the 155-mm gun carriage, M3, in firing position, with battery tools, equipment and accessories

RA PD 37708

**155-MM GUN MATERIEL, M1917, M1918 AND MODIFICATIONS**

Weight of two large spades.....	1220 lb.
Weight of remainder of carriage.....	10,180 lb.
Weight of limber.....	2630 lb.
Total weight, gun (8715 pounds), carriage and limber...	25,905 lb.
Reaction of each carriage wheel (road position).....	7935 lb.
Reaction of each limber wheel (road position).....	4920 lb.
Weight of one carriage wheel, rim and tire.....	600 lb.
Weight of one limber wheel, rim and tire.....	340 lb.

**Dimensions:**

Width of track, center to center of wheels—carriage.....	91½ in.
—limber.....	90½ in.
Greatest width (outer sidewalls of tires).....	106 in.
Height of center line of bore from ground (at 0° elevation).....	60⅞ in.
Height of line of sight above ground (at 0° elevation).....	76⅝ in.
Height of cradle trunnion centers above ground.....	58⅛ in.
Height of top of counterbalance.....	69⅜ in.
Height of top of end of muzzle (in traveling position).....	69¾ in.
Greatest height in traveling position (tip of quadrant sight panoramic telescope mounting shank).....	74⅜ in.
Wheelbase, carriage and limber.....	14⅝ ft.
Length over-all, traveling position, gun, carriage and limber.....	31⅝ ft.
Diameter of turning circle.....	60¾ ft.
Length over-all, with tractor, TD 18.....	47½ ft.

**Road clearance:**

Carriage—elastic suspension adjustment nut stud nut.....	12½ in.
Limber—bottom of brush guard.....	9¼ in.

**e. Maneuvers.**

Range movement in elevation.....	0° to 35° (622.2 mils)
Movement in elevation for one turn of the hand-wheel.....	28.72 min. (8½ mils)
Traverse to right or left from mid-position.....	30° (533½ mils)
Movement in azimuth for one turn of the traversing handwheel.....	0° 43' 2" (12.8 mils)

ICATIONS

- 1220 lb.
- 0,180 lb.
- 2630 lb.
- 5,905 lb.
- 7935 lb.
- 4920 lb.
- 600 lb.
- 340 lb.

Section II

DESCRIPTION AND FUNCTIONING OF GUN

Paragraph

Gun, general.....	5
Barrel assembly.....	6
Breechblock.....	7
Breechblock carrier.....	8
Obturator.....	9
Firing mechanism.....	10
Counterbalance mechanism.....	11
Breech mechanism functioning 155-mm guns, M1918MI and M1917A1.....	12

- 91 1/2 in.
- 90 1/2 in.
- 106 in.
- 50 7/8 in.
- 16 5/8 in.
- 18 1/8 in.
- 19 3/8 in.
- 9 3/4 in.
- 4 3/8 in.
- 4 5/8 ft.
- 1 5/8 ft.
- 1 3/4 ft.
- 1 1/2 ft.

5. GUN, GENERAL

a. The 155-mm guns, M1917, M1917A1 and M1918MI, are of built-up type, consisting of a tube strengthened by the necessary ring, jacket and hoops. The breech ring abuts the breech face of the tube. The breechblock carrier is hinged to the right side of the breech ring.

b. In recoil, the gun slides in a cradle, which is suspended by its trunnions. The recoil mechanism, housed in the cradle, is attached to the under side of the breech ring.

c. The 155-mm gun, M1917, is of French manufacture and was equipped with the original French breech and firing mechanism. The upper rear face of the breech ring carries the name "Puteaux" and the year of manufacture of the tube (fig. 6).

d. On most of these guns, the breech and firing mechanisms of the 155-mm gun, M1918MI, have been substituted for the original breech and firing mechanisms. Guns so modified are classified as 155-mm gun, M1917A1, and are identified by the model designation stamped on the rear face of the breech ring (fig. 6):

- .2 mils)
- 1/2 mils)
- 1/2 mils)
- 8 mils)

155-MM GUN MATERIEL, M1917, M1918 AND MODIFICATIONS

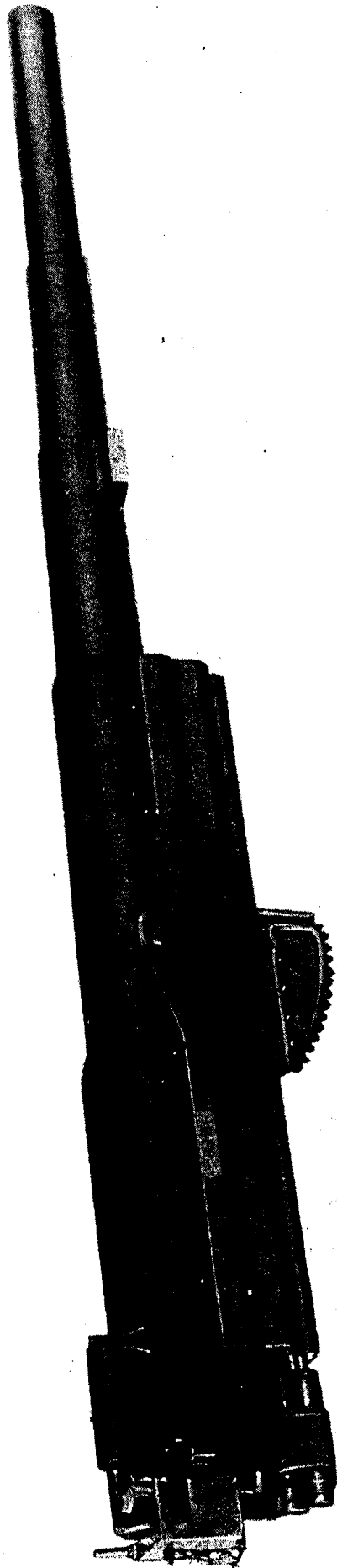

RA PD 37568

Figure 5—The 155-mm gun, M1917, M1917A1 and M1918M1, with breech mechanism, cradle, recoil mechanism and elevating sector

DESCRIPTION AND FUNCTIONING OF GUN

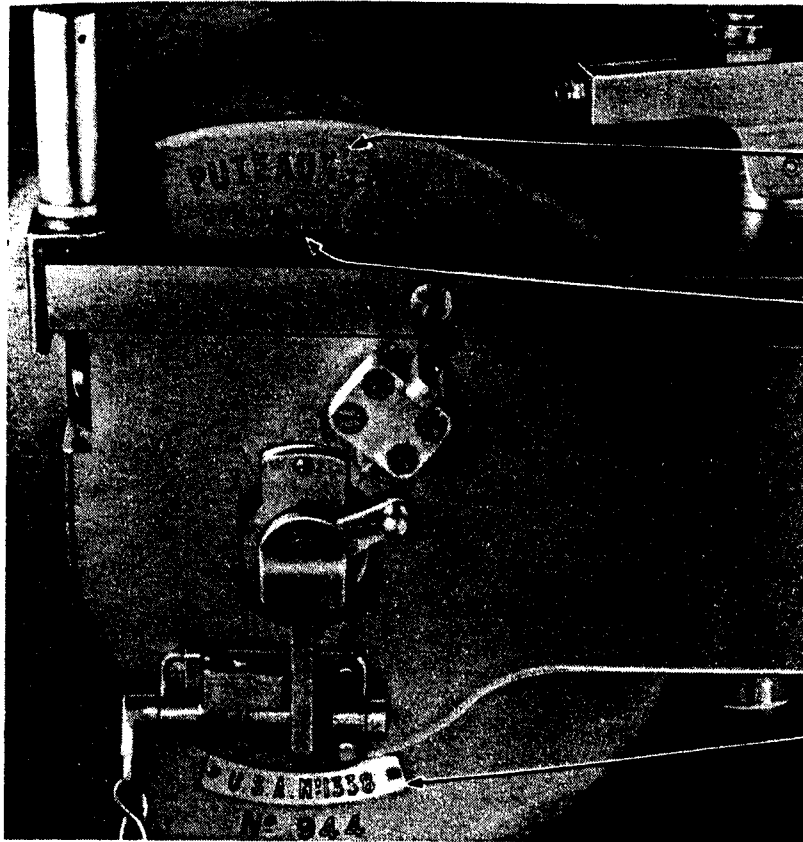

MANUFACTURER'S  
NAME AND YEAR  
OF MANUFACTURE  
OF TUBE

MODEL  
DESIGNATION  
OF GUN

SERIAL NUMBER  
OF GUN

RA PD 37569

Figure 6—Rear face of the 155-mm gun, M1917A1, showing marking

e. The 155-mm gun, M1918MI, is of American manufacture. It is identified by the model designation stamped on the rear face of the breech ring:

GUN 155-MM M1918MI

f. The breech mechanisms of the M1917 and M1918MI guns, as complete units, are interchangeable. When a 155-mm gun, M1917, is returned to the arsenal for repairs, the breech mechanism is modified to make the parts interchangeable with the 155-mm gun, M1918MI.

6. BARREL ASSEMBLY

a. The tube (fig. 7) is bored to form a chamber and bore, the bore rifling having 48 grooves. The grooves are right hand with a uniform twist of one turn in 29.89 calibers (inclination 6°). Bronze clips, secured to projections on the sides of the jackets and hoops, serve to guide the barrel as it slides in the cradle when fired, and when moved to and from traveling and battery position. The recoil pointer is secured to the right side of the tube jacket near the front end of the cradle.

b. The interior diameter of the breech ring (fig. 8) is provided with interrupted threads to receive the breechblock. A depression is

ICATIONS

RA PD 37568

Figure 5—The 155-mm gun, M1917, M1917A1 and M1918MI, with breech mechanism, cradle, recoil mechanism and elevating sector

155-MM GUN MATERIEL, M1917, M1918 AND MODIFICATIONS

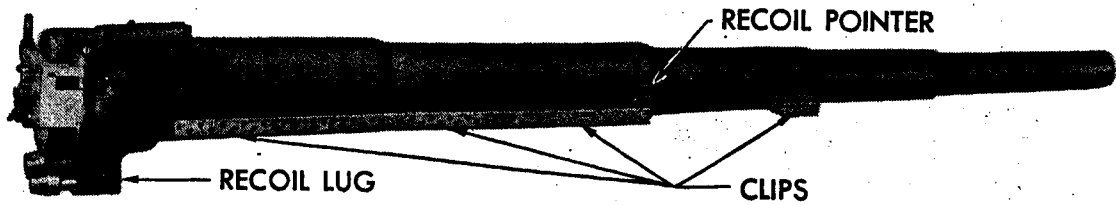

RA PD 37570

Figure 7—The barrel of the 155-mm gun, M1917, M1917A1 and M1918M1

provided at the bottom, just inside the breech ring for the lug of the loading tray. An extension on the under side of the breech ring forms a recoil lug by means of which the gun is connected to the recoil mechanism. Two lugs, on the right side, form a hinge for the breechblock carrier. The operating lever catch bracket, slightly in front of the hinge, forms a stop and serves to hold the breech mechanism in the open position. The counterbalance bracket is located above and forward of the operating lever catch bracket.

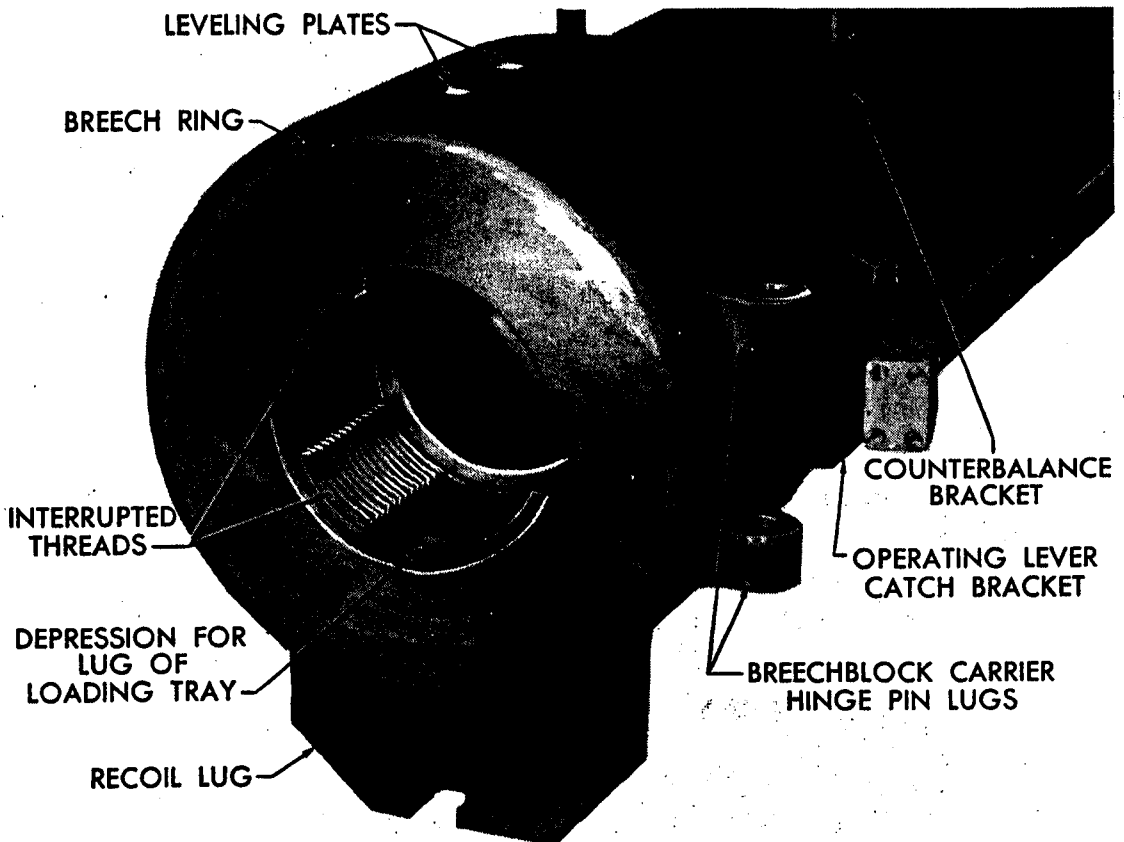

RA PD 37571

Figure 8—Breech end of the 155-mm gun, M1917, M1917A1 and M1918M1

c. Two leveling plates (fig. 8) of nickel silver are inlaid in the top of the breech ring. They parallel the axis of the gun and are used as seats for the gunner's quadrant when laying the gun.



DESCRIPTION AND FUNCTIONING OF GUN

7. BREECHBLOCK

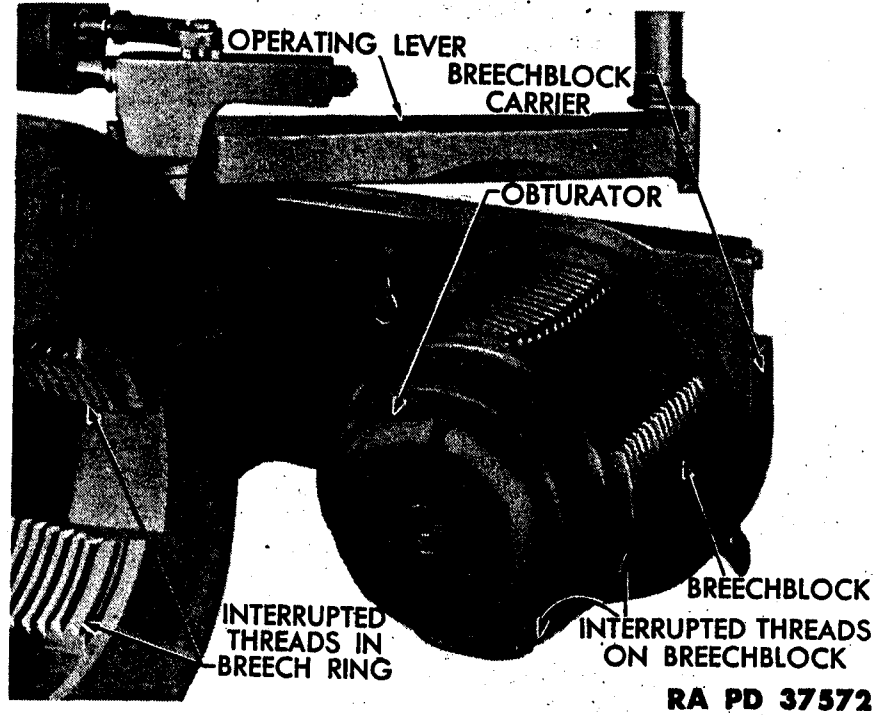

Figure 9—Breechblock showing interrupted threads

a. The breechblock (fig. 9) is of the cylindrical, interrupted screw type with a left hand buttress thread. The outer diameter of the threaded portion is divided into eight sectors, the threads being removed from alternate sectors. In closing, a one-eighth revolution of the breechblock in the breech recess engages the threads of the breechblock with the mating interrupted threads in the breech ring.

b. At the rear end of the breechblock and just back of the breech threads, the circumference is threaded (fig. 10) to screw into the breechblock carrier. Gear teeth are cut in a portion of this thread for the pur-

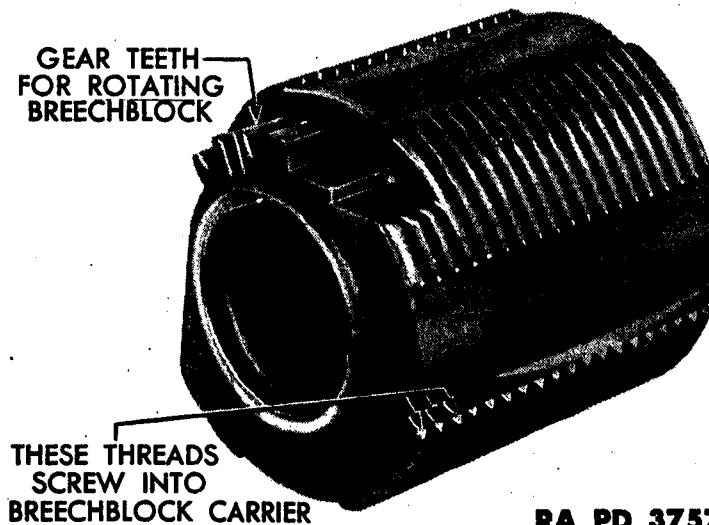

Figure 10—Breechblock carrier showing gear teeth for rotating

IFICATIONS

R

RA PD 37570  
M1918MI

the lug of the  
ring forms a  
mechanism.  
lock carrier.  
nge, forms a  
osition. The  
e operating

ERBALANCE  
ACKET

NG LEVER  
BRACKET

ARRIER  
IGS

37571

and

the top  
used as

RA PD 37573

## 155-MM GUN MATERIEL, M1917, M1918 AND MODIFICATIONS

pose of rotating the breechblock by means of a horizontally disposed rack, mounted in the breechblock carrier and moved by the operating lever. The breechblock is bored to receive the obturator spindle and the hub of the breechblock carrier.

## 8. BREECHBLOCK CARRIER

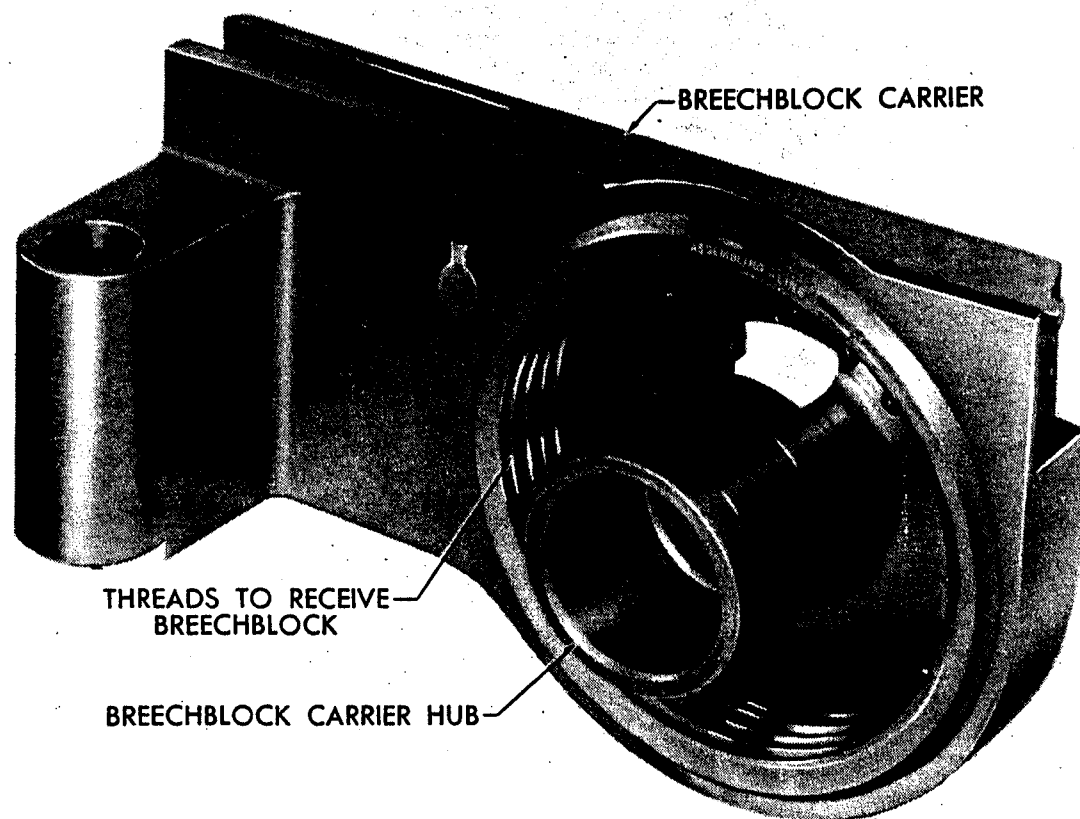

RA PD 37574

*Figure 11—Breechblock carrier showing hub*

a. The breechblock carrier (fig. 11) is hinged to lugs on the breech ring and is secured to the hinge pin by the hinge pin driving washer. It is threaded internally to receive the breechblock, and has a hub on which the breechblock is rotated by the action of the operating lever to be locked into place. The hub of the breechblock carrier incloses the firing mechanism housing, obturator spindle and its allied parts.

b. The rack (fig. 12) slides in the breechblock carrier and its teeth mesh with those on the breechblock. The lug which operates the rack is on the under side of the operating lever. Sockets for the rack lock and the lug of the operating lever are cut in the rack.

c. The operating lever (fig. 12) performs the function of first rotating the breechblock in the breechblock carrier until the threads are disengaged and then swinging the mechanism as a whole about the hinge pin until it is locked in an open position.

DESCRIPTION AND FUNCTIONING OF GUN

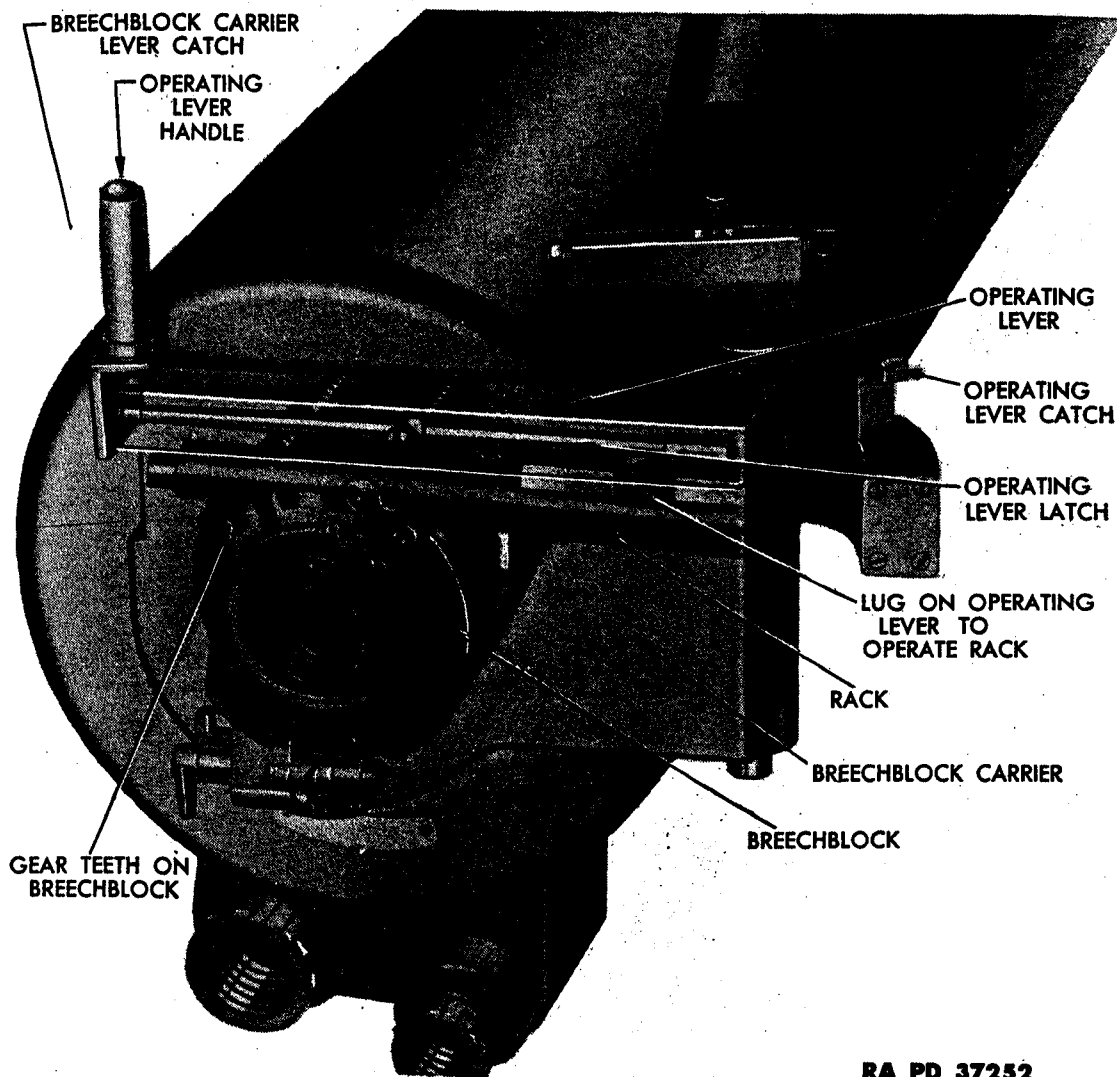

RA PD 37252

Figure 12—Phantom view of breechblock carrier, operating lever and operating lever handle

d. Within the operating lever handle (fig. 12) is an operating lever handle spring, which keeps the operating lever handle in a raised position, and prevents unlocking of the mechanism until pressure is brought to bear on the handle. An operating lever latch, running through the operating lever, holds the breech mechanism in the open position. The breechblock carrier lever catch locks the operating lever in closed position.

9. OBTURATOR

a. The obturator (fig. 9) seals the breech when the gun is fired. The obturator spindle passes through the breechblock and breechblock carrier. It is bored to provide a vent through which the charge is ignited by the percussion and firing mechanism.

b. The obturator assembly (fig. 12) consists of the obturator spindle, obturator front and rear split rings, obturator inner ring, obturator gas check pad, obturator filling-in disk, obturator spindle spring,

IFICATIONS  
ntally disposed  
the operating  
pindle and the

CARRIER

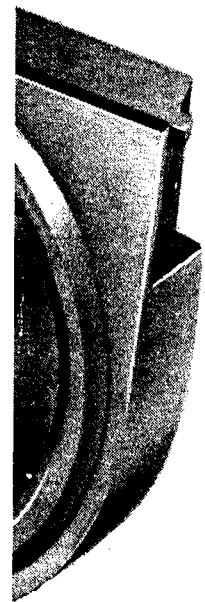

PD 37574

the breech  
asher. It is  
on which  
ver to be  
the firing

its teeth  
e rack is  
lock and

st rotat-  
are dis-  
he hinge

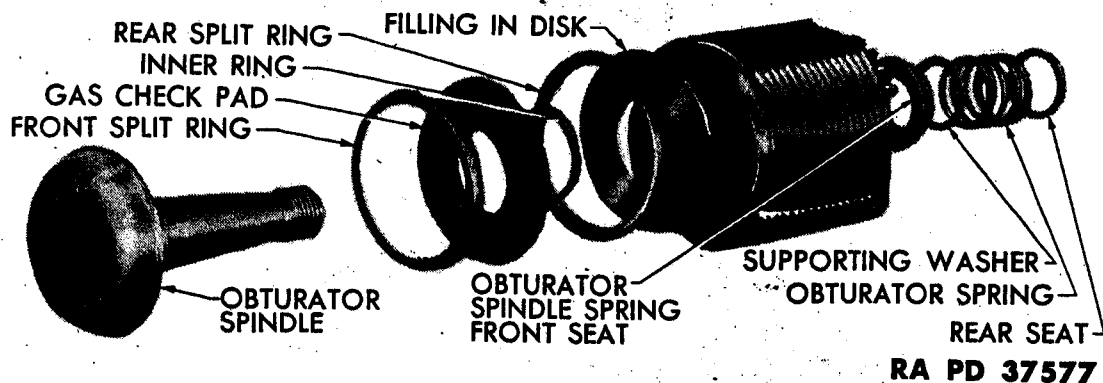

Figure 13—Exploded view of obturator assembly

obturator spindle spring supporting washer and obturator spindle spring front and rear seats. The gas check pad is made of one part nonfluid oil and three parts asbestos in a canvas or copper wire screen.

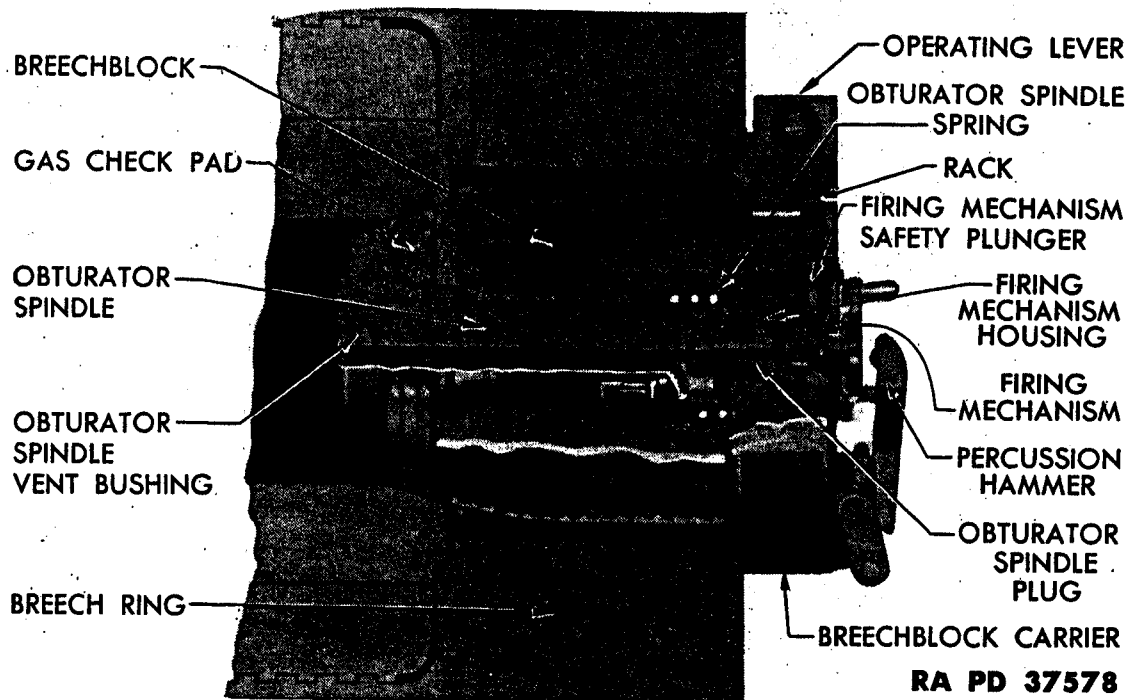

Figure 14—Cut-away view of obturator assembly

c. An obturator spindle vent bushing is screwed into the head of the obturator spindle (fig. 14). The obturator spindle plug is screwed into the rear end and forms the seat for the primer. A copper washer is inserted in front of the obturator spindle plug to make a gastight joint.

d. The firing mechanism housing is inserted into the breechblock carrier and over the rear end of the obturator spindle. This compresses the obturator spindle spring, thereby drawing the gas check pad and its allied parts to a firm bearing on the muzzle face of the breechblock.

## 10. FIRING MECHANISM

a. The firing mechanism of 155-mm guns, M1918MI and M1917A1

DESCRIPTION AND FUNCTIONING OF GUN

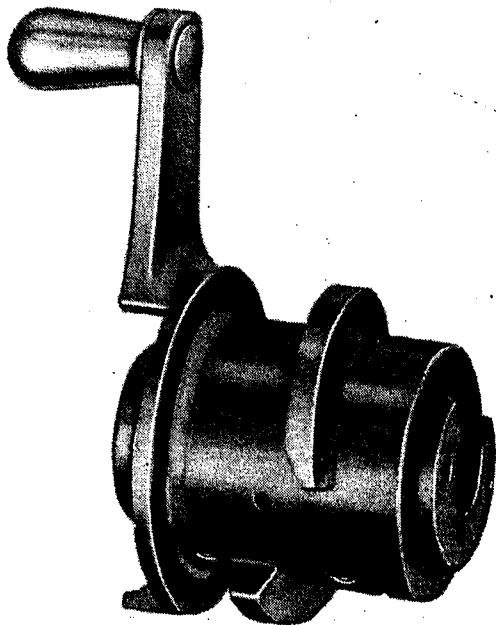

RA PD 37579

Figure 15—Firing mechanism, M1918, removed from breech

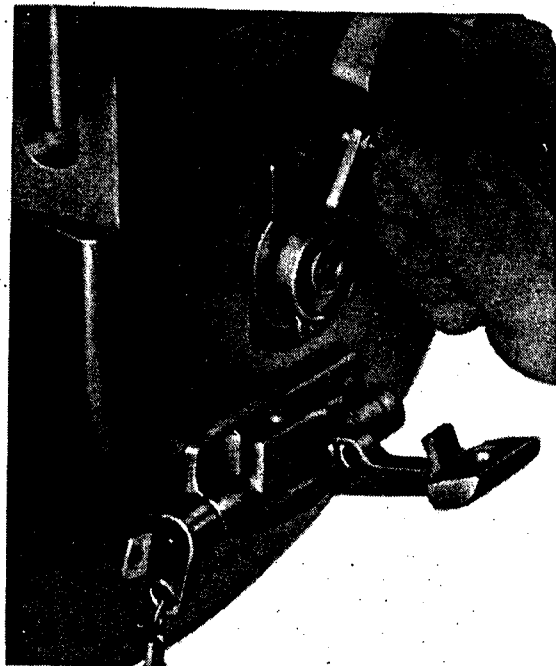

RA PD 37580

Figure 16—Firing mechanism, M1918, screwed into position

(fig. 15), differs somewhat in appearance, construction and operation from the original French type firing mechanism of the 155-mm gun M1917. These differences have slight effect on the service of the piece.

b. The firing mechanism, M1918, of the 155-mm guns, M1918MI

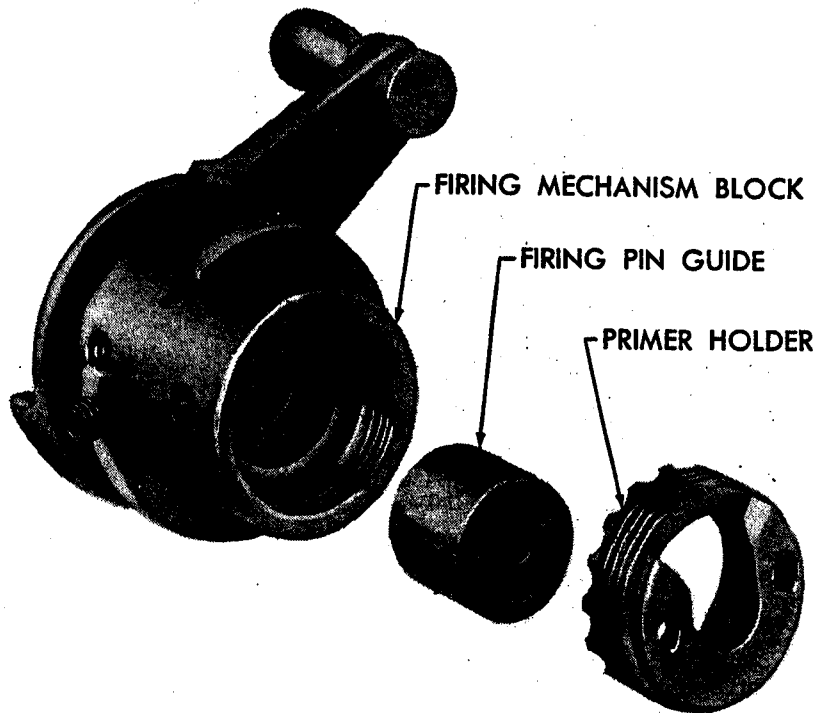

RA PD 37581

Figure 17—Exploded view of forward end of firing mechanism

FICATIONS

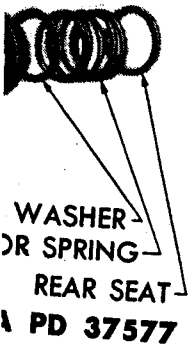

WASHER OR SPRING  
REAR SEAT  
RA PD 37577

single spring  
nonfluid oil

ACTUATING LEVER

ACTUATOR SPINDLE  
SPRING

ACTUATOR RACK  
MECHANISM  
PLUNGER

— FIRING  
MECHANISM  
HOUSING

FIRING  
MECHANISM

PERCUSSION  
HAMMER

OBTURATOR  
SPINDLE  
PLUG

ACTUATOR CARRIER  
RA PD 37578

the head of  
is screwed into  
her is in  
right joint.  
The block  
compresses  
it and its  
lock.

[1917A1

## 155-MM GUN MATERIEL, M1917, M1918 AND MODIFICATIONS

and M1917A1, is also common to 155-mm howitzer, M1918; 8-inch howitzers, M1917, Mks. VI and VIII½; 240-mm howitzers, M1918 and M1918MI. It is screwed into the firing mechanism housing.

c. The firing mechanism is composed of a firing mechanism block which contains the firing pin, compression spring, firing pin guide, firing pin housing, primer holder, firing mechanism shoe, and two safety set screws. The primer holder (fig. 17) has a slot to receive the head of the primer and is screwed into the forward end of the firing mechanism block, holding the firing pin guide in place.

d. The firing pin housing (fig. 18) is screwed into the rear end of the firing mechanism block and, as the name implies, houses the firing pin and firing pin compression spring. Safety set screws prevent the unscrewing of the primer holder and the firing pin housing. The firing mechanism shoe is provided to protect the firing pin housing threads when its safety set screw is tightened.

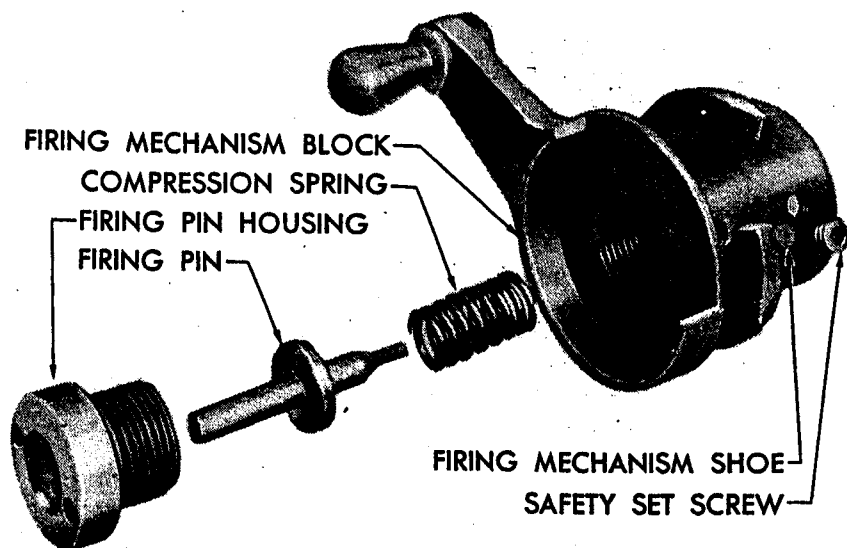

RA PD 37582

*Figure 18—Exploded view of rear end of firing mechanism*

e. The firing mechanism block is provided with a handle (fig. 18) for screwing the firing mechanism into the firing mechanism housing. It can be completely screwed into the housing only when the breech mechanism is closed, as the firing mechanism safety plunger (fig. 14) prevents complete assembly at any other time.

f. Another safety feature of the firing mechanism is the safety flange (fig. 19) on which the lug on the percussion hammer strikes and thus prevents firing, unless the firing mechanism is screwed fully home. If the firing mechanism is screwed fully home (fig. 20), the lug on the percussion hammer drops into a recess in the flange.

DESCRIPTION AND FUNCTIONING OF GUN

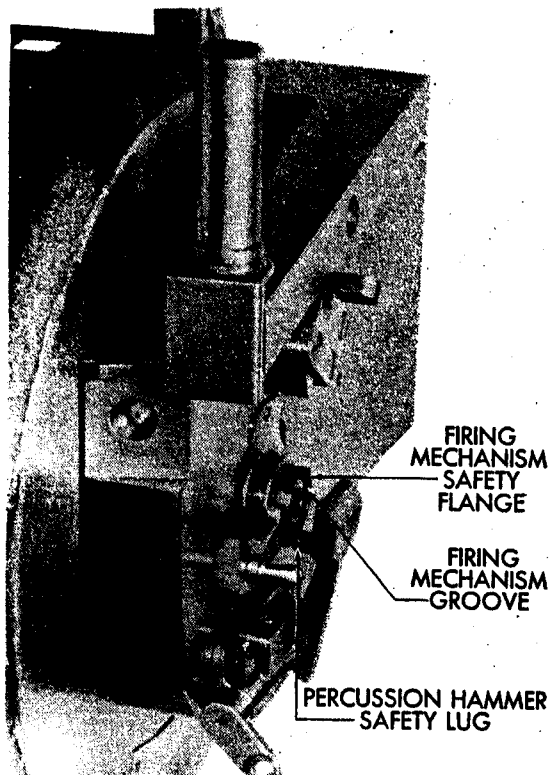

RA PD 37583

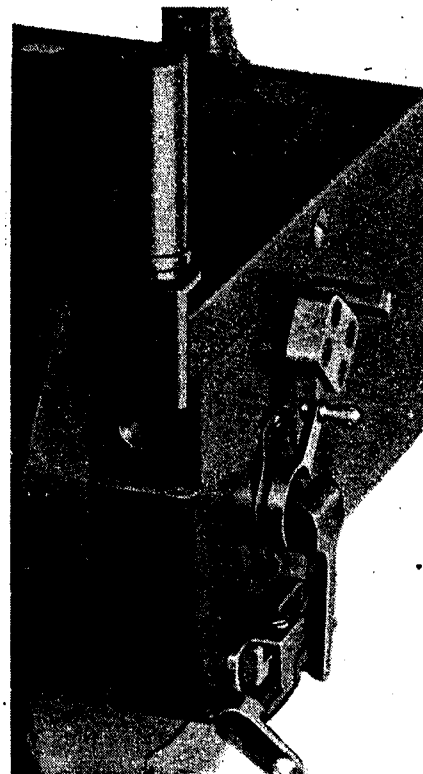

RA PD 37584

**Figure 19—Firing mechanism not screwed fully home. Percussion hammer on safety flange**

**Figure 20—Firing mechanism screwed home. Percussion hammer in lug groove**

**CAUTION:** Each battery is provided with a gage to determine when the lug on the percussion hammer is worn beyond the safety limit. When this gage will pass over the lug, the percussion hammer should be replaced.

g. The firing mechanism safety plunger and firing mechanism safety plunger spring are located in the upper part of the firing mechanism housing. The plunger is prevented from seating properly on its bearing surface when the breech mechanism is not fully closed. This forces the firing mechanism safety plunger to protrude through and into the space occupied by the firing mechanism, thereby preventing the seating of the firing mechanism (fig. 14).

**CAUTION:** It is possible to insert the firing mechanism partially before closing the breechblock. **THIS PRACTICE IS STRICTLY PROHIBITED.**

h. The firing mechanism block latch (fig. 21) is attached to the breechblock carrier at the right and a little above the firing mechanism housing. Its function is to prevent the firing mechanism from unscrewing during firing.

i. The percussion mechanism (fig. 21) is attached to the rear face

## 155-MM GUN MATERIEL, M1917, M1918 AND MODIFICATIONS

of the breechblock carrier below the firing mechanism housing. The percussion hammer is attached to the percussion hammer operating shaft, which is held in place by the percussion hammer operating shaft collar and percussion hammer operating shaft collar detent.

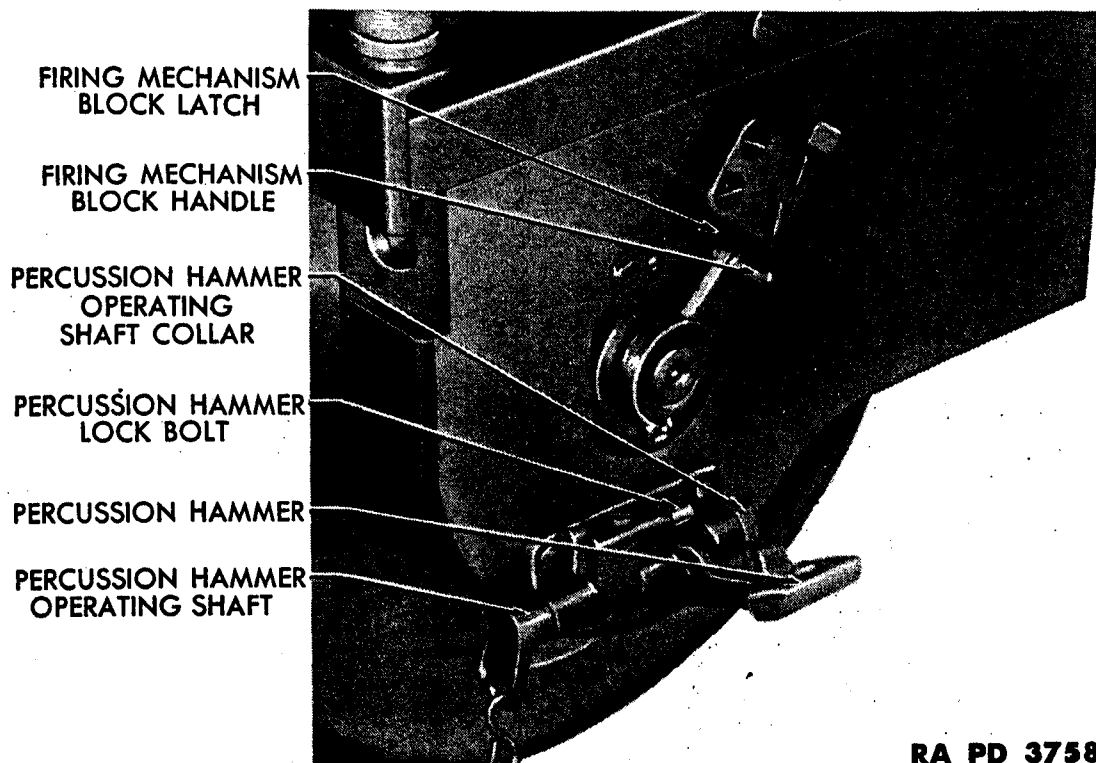

RA PD 37585

**Figure 21—Firing mechanism block latch and percussion mechanism**

j. The percussion hammer lock bolt (fig. 21) has a knurled finger grip and is encased in the percussion hammer operating shaft housing. Its function is to hold the percussion hammer stationary when the gun is in traveling position and out of action, unless the gun is ready to be fired. In firing, as a safety precaution, the percussion hammer lock bolt will be locked immediately after the breech is opened. This bolt will not be unlocked until after the breechblock has been locked in the closed position and the gun is ready to be fired.

## 11. COUNTERBALANCE MECHANISM

a. When the gun is elevated, the counterbalance (fig. 22) makes the breech mechanism easier to open and close, by offsetting the effect of gravity on its operation. It consists of a counterbalance cylinder attached to the gun by the counterbalance bracket. The counterbalance tension rod, which slides in this cylinder, is attached at one end to the counterbalance piston, which acts upon the counterbalance spring, while a socket on the other end fits around the counterbalance regulating nut.

b. The counterbalance regulating nut (fig. 22) is fitted to the



DESCRIPTION AND FUNCTIONING OF GUN

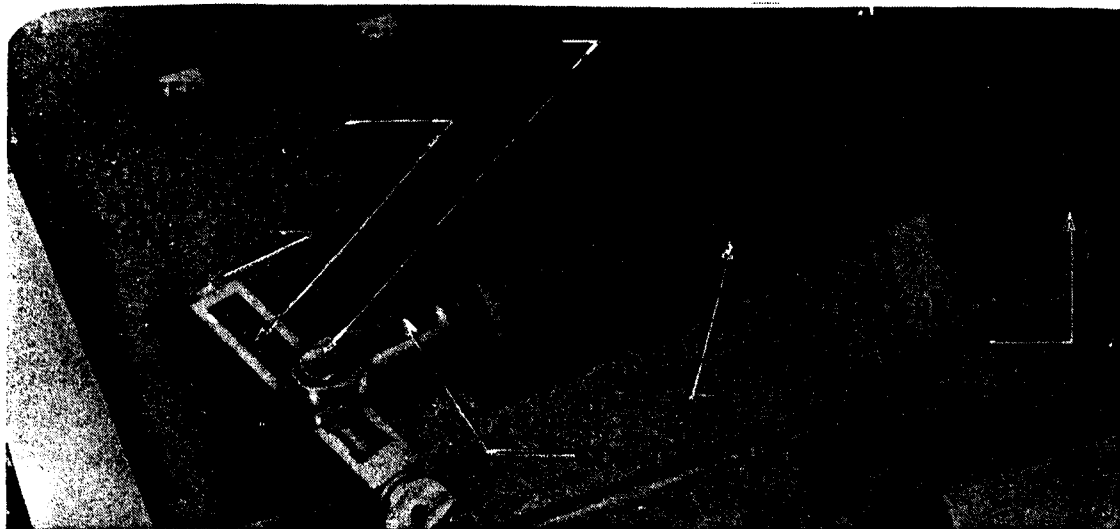

RA PD 37586

Figure 22—Counterbalance cylinder and counterbalance regulating screw

counterbalance regulating screw, seated in a slotted arm which is a projection of the breechblock carrier hinge pin. By rotating the counterbalance regulating screw, the counterbalance regulating nut is moved to increase or decrease the tension of the counterbalance spring as desired, according to the angle of fire.

12. BREECH MECHANISM FUNCTIONING, 155-MM GUNS, M1918MI AND M1917A1

a. To Open the Breech. (1) Raise the firing mechanism block latch and remove the firing mechanism by unscrewing it to the left. Grasp the operating lever handle, press it down to disengage the breechblock carrier lever catch, and pull on the operating lever handle.

(2) In the first part of its movement, the operating lever turns on the hinge pin without moving the breechblock carrier, but its lug operates the rack which turns the breechblock, disengaging its threads from those of the breech ring. When the breechblock is completely unlocked, its further rotation is prevented by a lug on the rack coming in contact with the rack lock and preventing further movement of the operating lever without also moving the breechblock carrier.

(3) Further pull on the operating lever handle draws the breech carrier away from the gun, and permits the rack lock to be forced upward into its seat in the rack by the action of the rack lock spring, thus locking the breechblock in the proper position in the breechblock carrier. When the breechblock carrier is swung until it strikes the block carrier stop, the operating lever latch, in the operating lever, catches on the operating lever catch and locks the breech mechanism in its open position.

(4) The hinge pin is locked to the breechblock carrier by the hinge pin driving washer, and so is forced to turn with the breechblock carrier.

MODIFICATIONS

using. The per-  
operating shaft,  
ing shaft collar

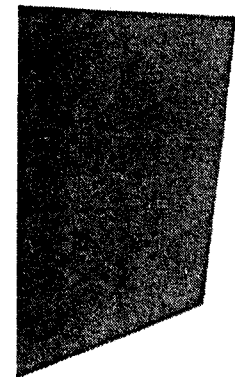

RA PD 37585

Mechanism

curled finger  
shaft housing.  
When the gun  
ready to be  
er lock bolt  
bolt will not  
the closed

22) makes  
g the effect  
ce cylinder  
terbalance  
end to the  
ring, while  
lating nut.  
ed to the

**155-MM GUN MATERIEL, M1917, M1918 AND MODIFICATIONS**

The rotary motion thus developed creates a pull on the counterbalance tension rod through the lever arm and stores energy to facilitate closing the breech.

b. **To Close the Breech.** (1) Press down on the operating lever handle to disengage the operating lever latch from the operating lever catch; then, pull on the operating lever handle to cause the breechblock carrier to swing against the rear face of the gun. The counterbalance, if properly adjusted, will facilitate the closing.

(2) The forward end of the rack lock, projecting from the front face of the breechblock carrier, strikes the breech ring and is pushed back into its seat, freeing the rack. The rack moves to the left, screwing the breechblock home, as the operating lever continues to rotate about the axis of the hinge pin. The operating lever comes to rest when the operating lever latch engages the breechblock carrier lever catch on the breechblock carrier.

**CAUTION:** The breech of the M1917A1 and M1918MI gun cannot be opened while the firing mechanism is in place because the firing mechanism safety plunger cannot move.

c. **To Fire.** (1) The firing mechanism is held in the hand and loaded by inserting a primer into the primer holder. This locates the percussion cap in the primer directly in front of the firing pin. The firing mechanism is then screwed into the firing mechanism housing. When the firing mechanism handle has passed the firing mechanism block latch, it has seated the primer in the obturator spindle plug.

(2) Firing of the M1917A1 and M1918MI guns is accomplished by giving a quick pull on the lanyard, which is hooked to the arm on the left end of the percussion hammer operating shaft.

Section III

DESCRIPTION AND FUNCTIONING OF CARRIAGE

	Paragraph
Carriage, general.....	13
Cradle.....	14
Recoil mechanism.....	15
Counterrecoil mechanism.....	16
Top carriage.....	17
Bottom carriage and axle.....	18
Trails.....	19
Wheels and tires.....	20
Air brakes.....	21
Air brake functioning.....	22
Electric brakes.....	23
Hand-operated mechanical brakes.....	24
Hand brakes.....	25
155-mm gun seacoast emplacement.....	26

13. CARRIAGE, GENERAL

a. The 155-mm gun carriages, M2 and M3, are modified and improved gun carriages of the French design "Grande Puissance Filloux" (G. P. F.), which means a gun and carriage of great power, and the name of the inventor.

b. The original gun carriages of this type were known as the 155-mm gun carriages, M1917 and M1918. They were equipped with hard rubber tires and hand brakes and were intended to be horse-drawn at slow speeds.

c. These gun carriages were later modified for high speed transport by the addition of electrically-operated brakes and wheels carried upon roller bearings. Gun carriages with these modifications are known as the 155-mm gun carriages, M1917A1 and M1918A1.

d. The 155-mm gun carriages, M2 and M3, are modifications of M1917 and M1917A1, and M1918 and M1918A1 gun carriages respectively. They embody important improvements for modern high speed transport—namely, pneumatic tires and airbrakes.

e. The differences between the 155-mm gun carriages, M2 and M3, are so minor that they do not materially affect troop use and care.

f. The carriages are of the split-trail type and possess great ruggedness and ease of operation in supporting and controlling the movement of the gun.

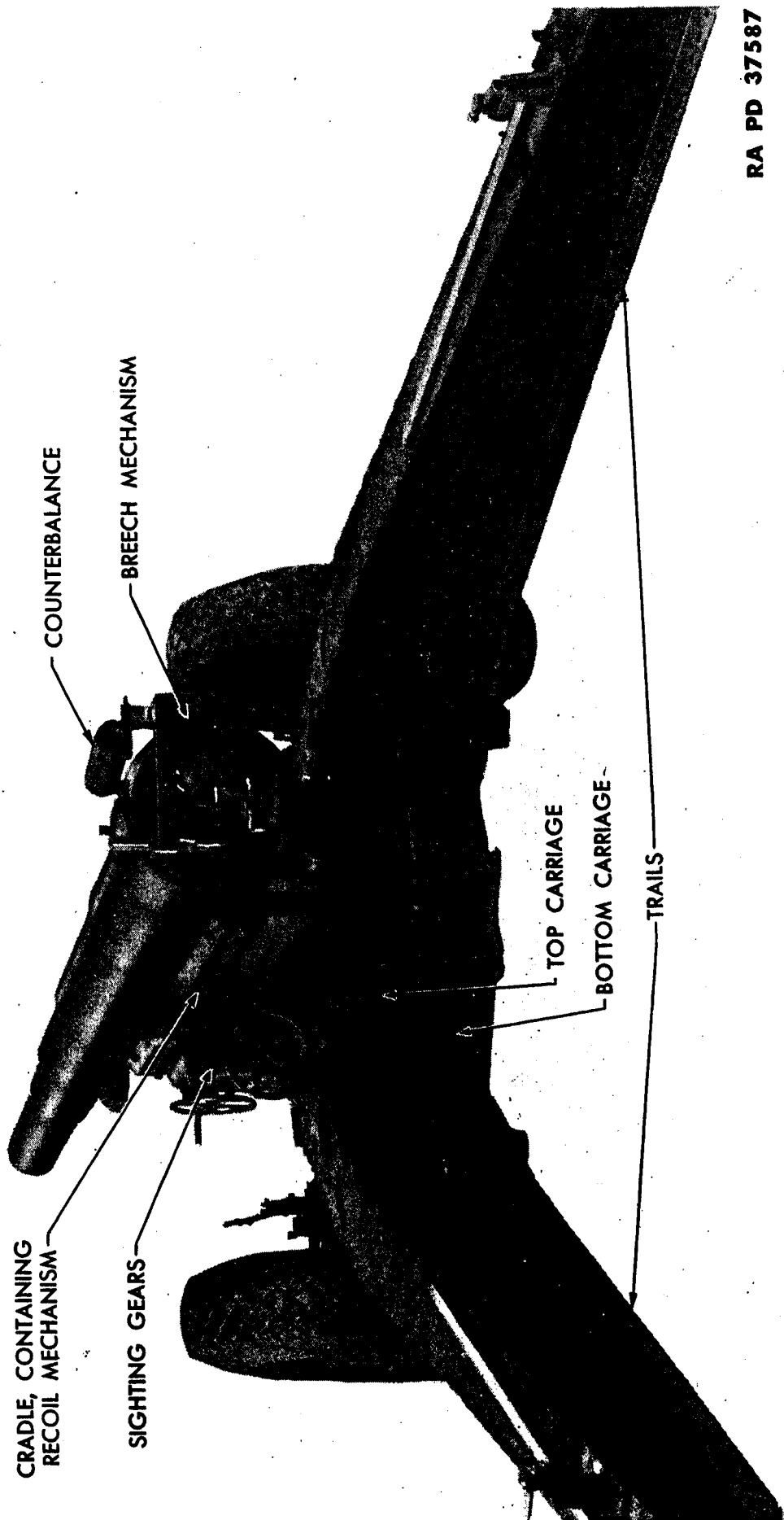

Figure 23—The 155-mm gun, M1917A1, and the 155-mm gun carriage M2, in firing position

car  
the  
mi  
14

MODIFICATIONS

RA PD 37587

Figure 23—The 155-mm gun, M1917A1, and the 155-mm gun carriage M2, in firing position

DESCRIPTION AND FUNCTIONING OF CARRIAGE

g. The firing stresses are transmitted through the trunnions, top carriage, bottom carriage and trails to the spades which are attached to the rear ends of the trails. The spades, being buried in the ground, transmit the reaction back to the trails and prevent movement of the carriage

14. CRADLE

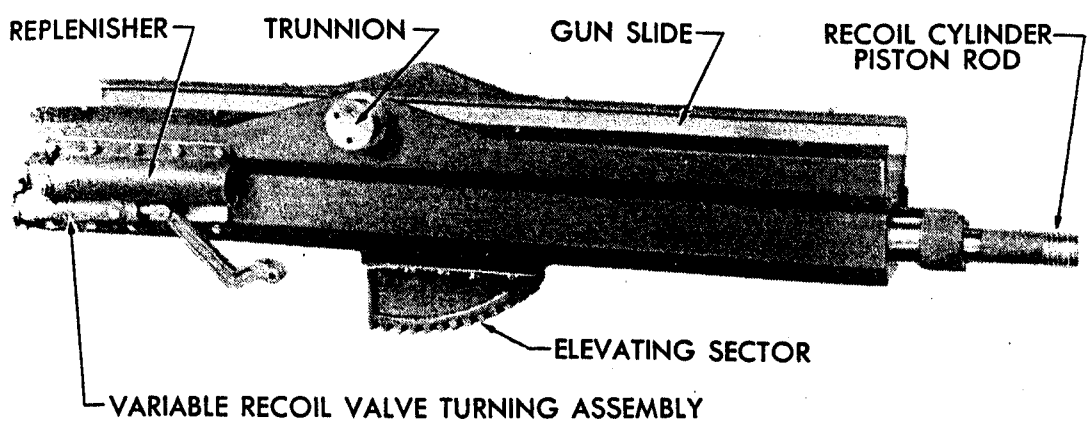

RA PD 37588

Figure 24—The cradle in which the gun is carried and in which it slides in recoil and counterrecoil

a. The cradle (fig. 24) is suspended by its trunnions, resting in the trunnion bearings of the top carriage. The gun is carried, and slides in recoil and counterrecoil, in guiding slots formed in the upper portion of the cradle. The largest of the three bores in the lower portion of the cradle contains the recoil system, while the other two house the counterrecoil system.

b. The elevating sector (fig. 24) is bolted firmly to the under side of the cradle. The sector has 13 teeth, which engage a worm gear in the top carriage, to provide a range movement in elevation of 0° to 35°. The replenisher cylinder or automatic filler for the recoil system is bolted to the left front side of the cradle. Knurled head oil cups extend through the upper beveled faces of both sides of the cradle.

15. RECOIL MECHANISM

a. The recoil system is of hydro-pneumatic variable recoil type. The purpose of the recoil system is to control the backward thrust of the gun created by firing, and to check the movement of the recoiling mass in a manner so gradual as not to cause displacement of the carriage. With this type of recoil system, the length of recoil is automatically shortened as the angle of elevation of the gun is increased. The recoil system is distinctly separate from the counterrecoil system.

b. The recoil mechanism is connected through its piston rod to the lower lug of the breech ring by the larger of the two nuts which protrude

155-MM GUN MATERIEL, M1917, M1918 AND MODIFICATIONS

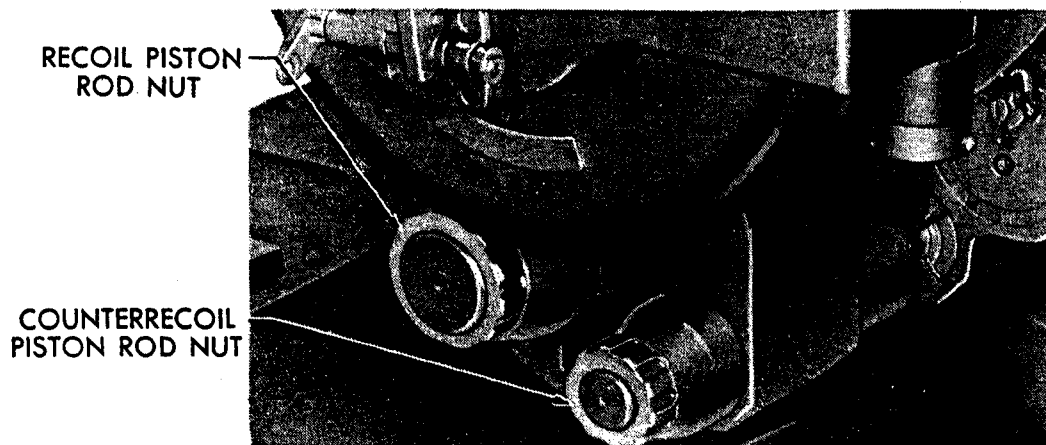

RA PD 37589

**Figure 25—Recoil and counterrecoil piston rod nuts**

from the rear of this lug (fig. 25). This nut, as well as the smaller one which connects the counterrecoil connecting rod to the gun, is screwed into position when the gun is placed in firing position. In recoil, these connecting rods are carried backward with the gun.

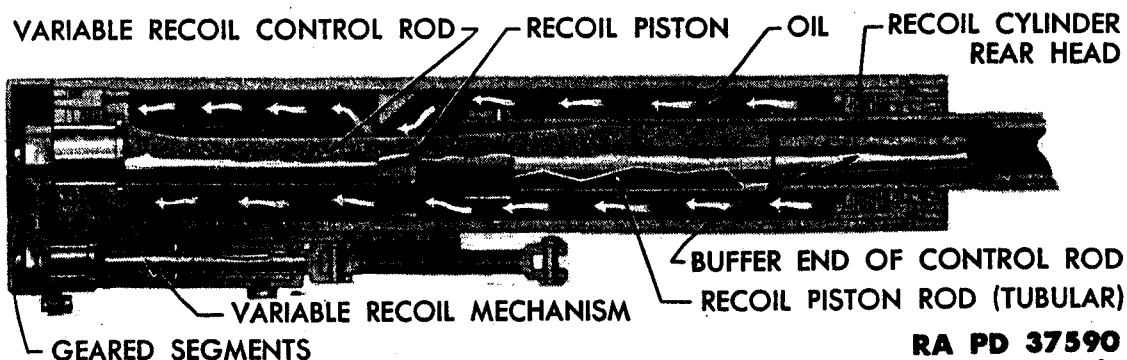

RA PD 37590

**Figure 26—Sectional view of recoil cylinder and valve turning mechanism, showing movement of oil when gun is fired**

c. All space in the recoil cylinder (fig. 26), not occupied by the recoil connecting rod (which is tubular), the variable recoil control rod (which is inside the connecting rod), and the recoil piston, is filled with oil. The oil between the recoil piston and the recoil cylinder rear head must, in recoil, pass through ports and control rod grooves, snubbing the recoil of the gun. These grooves are so arranged that rotation of the control rod varies the area of the orifices through which the oil must pass.

d. The rotation of the control rod is accomplished by geared segments (fig. 27) linked to the top carriage in such manner that the position of the rod is automatically controlled by the elevation of the cradle.

e. The replenisher cylinder, or automatic filler (fig. 27), communicates with the recoil cylinder and assures a sufficient supply of oil as long as it contains oil. It also serves as a reservoir to permit the escape

**MODIFICATIONS**

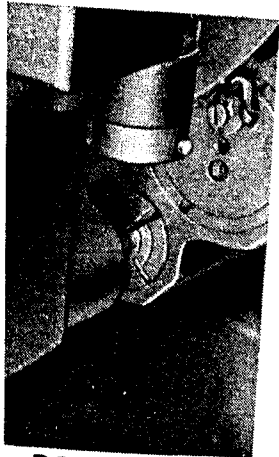

RA PD 37589

**d nuts**  
is the smaller one  
ie gun, is screwed  
1. In recoil, these

RECOIL CYLINDER  
REAR HEAD



OF CONTROL ROD  
N ROD (TUBULAR)  
RA PD 37590

**turning mecha-**  
**ed**  
occupied by the  
coil control rod  
n, is filled with  
inder rear head  
oves, snubbing  
rotation of the  
e oil must pass.

by geared seg-  
at the position  
he cradle.  
27), communi-  
ply of oil as  
nit the escape

**DESCRIPTION AND FUNCTIONING OF CARRIAGE**

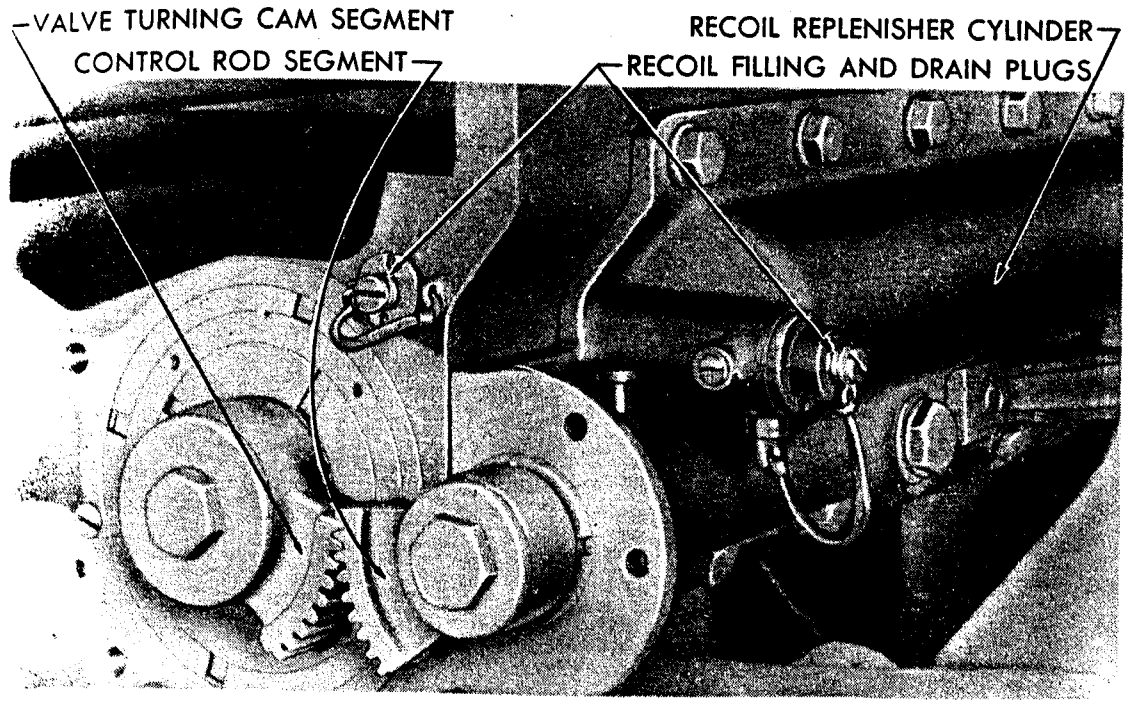

RA PD 37591

**Figure 27—Variable recoil geared segments and replenisher cylinder**

of excess oil from the recoil cylinder resulting from expansion developed during firing or hot weather.

f. The replenisher piston (fig. 28) inside the replenisher cylinder is driven forward by the replenisher piston spring, keeping the oil in the replenisher cylinder under compression at all times. Should there be no oil in the replenisher, the spring will force the piston until it stops against the front wall of the cylinder. The piston is prolonged to the rear, the extension serving as a guide to hold the piston in line. It also serves as a gage for determining the quantity of recoil oil in the replenisher.

g. To determine the amount of reserve recoil oil, a 300-millimeter rule is inserted into the opening in the center of the rear face of the replenisher and pushed until it comes in contact with the rear end of the replenisher piston extension (fig. 28). Read the graduation of the rule which is level with the rear face of the replenisher. The normal working position, indicative of the correct amount of recoil oil, is  $5\frac{15}{16}$  inches (150-mm). See paragraph 38.

h. When it is necessary to add oil to the recoil system to compensate for leakage, it is done through the recoil filling valve in the front of the replenisher housing. A filling and drain plug is inserted in the front of the cradle for the removal of oil and air from the recoil system. (See fig. 27.) For instructions for draining and filling, see paragraph 53 l.

155-MM GUN MATERIEL, M1917, M1918 AND MODIFICATIONS

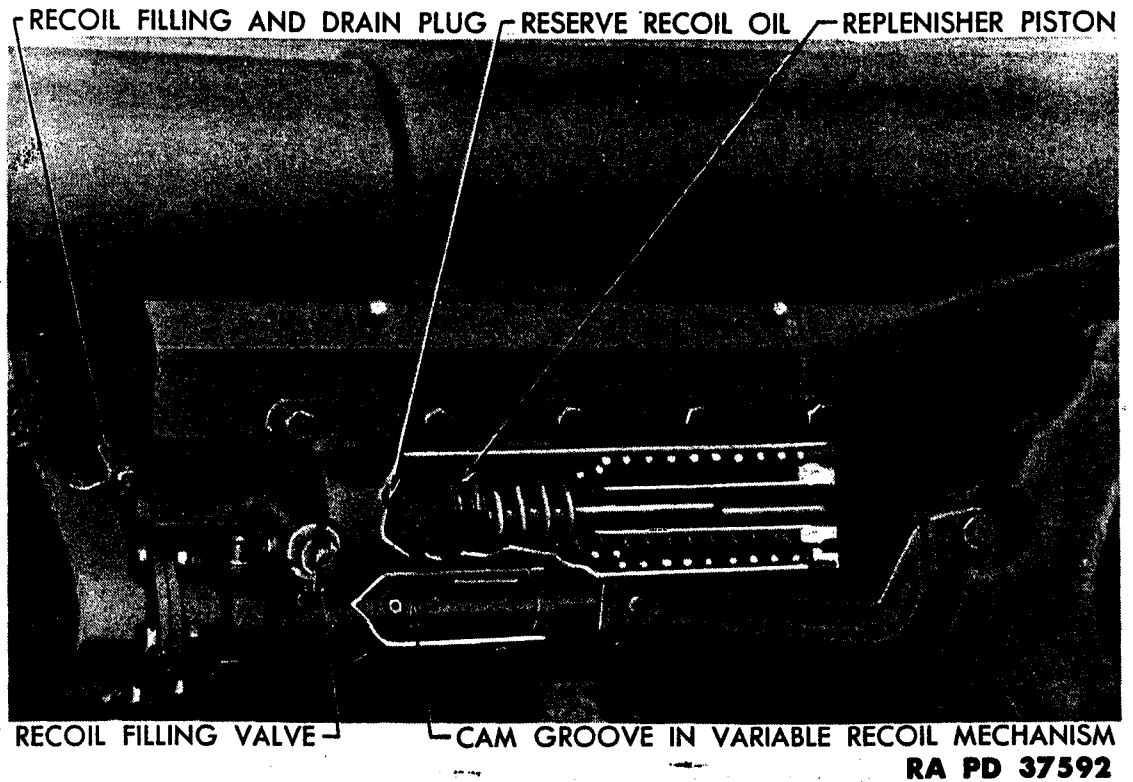

**Figure 28—Cut-away view of replenisher and valve turning mechanism**

i. The recoil pointer (fig. 29) is provided to indicate the length of recoil. It is attached to the right side of the gun, resting lightly on top of the cradle near the front end. The pointer will trace a record of the length of recoil in grease, chalk or other substance placed on the cradle previous to firing. The maximum length of recoil is 70.9 inches. The proper recoil distances at various elevations of the gun are given in paragraph 53 j.

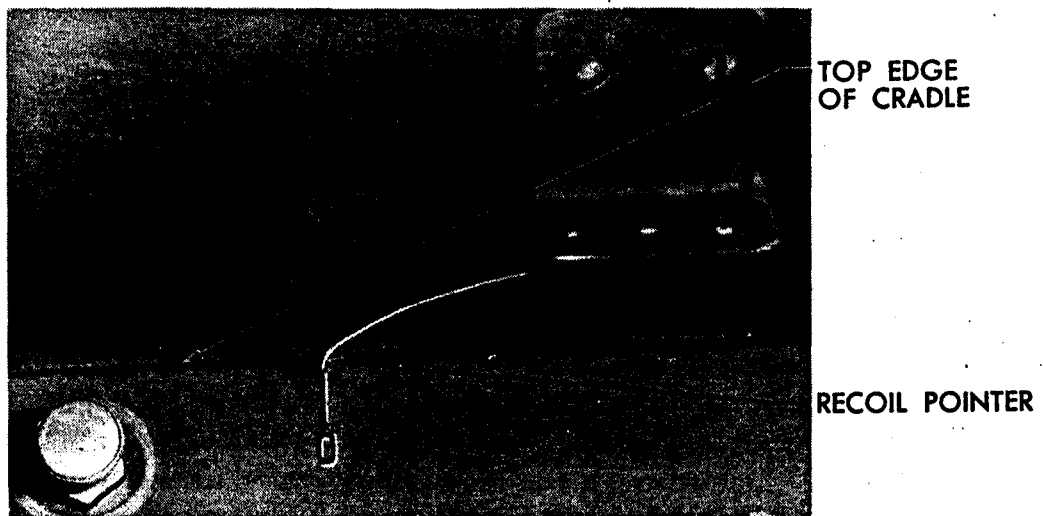

**Figure 29—Recoil pointer used to gage the length of recoil**



MODIFICATIONS

DESCRIPTION AND FUNCTIONING OF CARRIAGE

16. COUNTERRECOIL MECHANISM

a. The counterrecoil system is for the purpose of returning into battery the recoiled mass of the gun in order that it may be fired again. The counterrecoil system occupies the counterrecoil cylinder and the recuperator cylinder of the cradle.

b. At a manufacturing arsenal, the recuperator cylinder of the counterrecoil system is filled with nitrogen at a pressure of 112 kilograms per square centimeter at 20 C., which corresponds to 1592 pounds per square inch at 68 F. The pressure varies with changes in temperature.

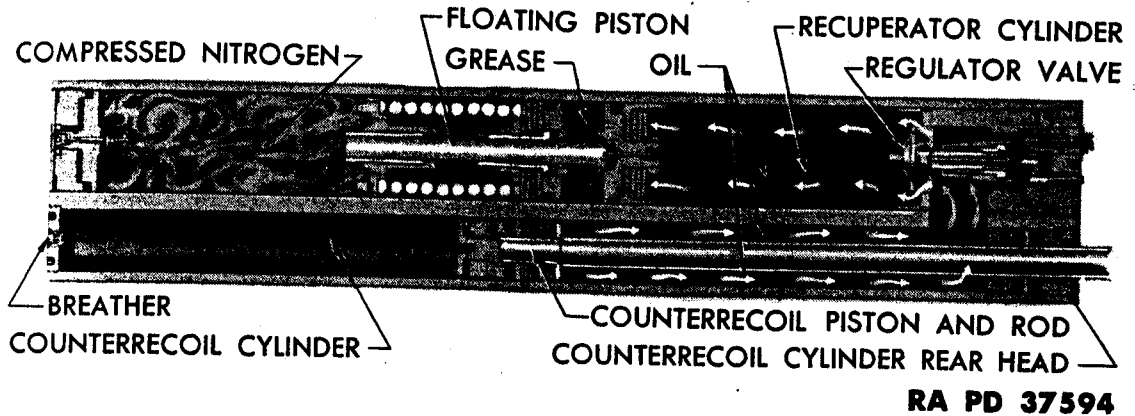

Figure 30—Sectional view of the counterrecoil and recuperator cylinders, showing movement of oil when gun is fired

c. The recuperator cylinder (fig. 30) houses the floating piston, which separates the compressed nitrogen in the forward end of the cylinder from the oil at the rear of the floating piston. The counterrecoil cylinder, which has direct communication with the recuperator cylinder, houses the counterrecoil piston and rod, the rear end of which is attached to the breech ring of the gun.

d. In recoil, the oil between the counterrecoil piston and the counterrecoil cylinder rear head is forced through the communicating orifice into the recuperator cylinder, where it forces the floating piston forward and builds up sufficient pressure in the nitrogen to return the gun to battery after the gun has finished recoiling (fig. 30).

e. In counterrecoil, the expansion of the compressed nitrogen forces the floating piston to the rear. It, in turn, drives the oil against the regulator valve, which closes, leaving two small holes for the passage of oil escaping into the counterrecoil cylinder. In the latter cylinder, the oil forces the counterrecoil piston and rod forward, forcing the gun into battery.

f. The purpose of the two small holes in the regulator valve is to throttle the oil and reduce the speed of counterrecoil. The effect of such

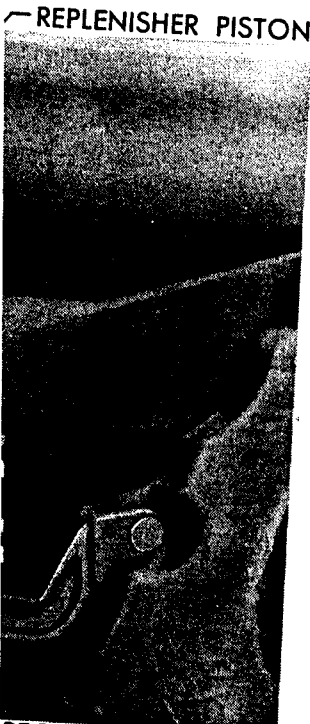

RECOIL MECHANISM  
RA PD 37592

ning mechanism

cate the length of  
ng lightly on top  
e a record of the  
ed on the cradle  
70.9 inches. The  
gun are given in

EDGE  
CRADLE

IL POINTER

RA PD 37593

coil

## 155-MM GUN MATERIEL, M1917, M1918 AND MODIFICATIONS

throttling, at the regulator valve, is to ease the gun into battery without shock.

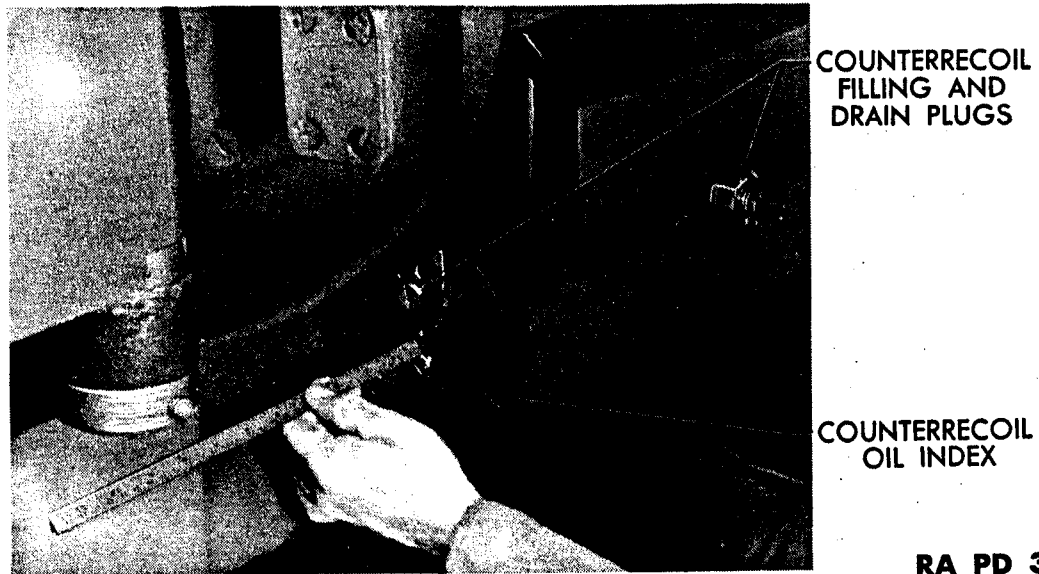

RA PD 37595

**Figure 31—Measuring the oil index to determine the amount of counterrecoil reserve oil**

g. The small amount of oil which separates the floating piston from the regulator valve is known as the counterrecoil reserve oil. Should this oil be reduced through leakage, the floating piston would bear against the regulator valve. Damage to the mechanism would occur if the gun were fired under this condition. An oil index in the recuperator cylinder rear head (fig. 31) indicates whether or not reserve oil is present.

h. If there is a full reserve, the oil index will project  $\frac{3}{16}$  inch (5 mm). If there is no reserve, the oil index will disappear into the cylinder head and the system must be filled before firing. Filling is accomplished with the battery pump or the oil screw filler through the filling valve set in the right side of the cradle, about six inches from the rear end. A filling and drain plug is provided in the recuperator rear cylinder head. For instructions for filling or draining, see paragraph 53 o.

i. If the nitrogen is passing the floating piston into the oil, it may be detected by the foamy or emulsified appearance of the oil as it is drained out. If the nitrogen cylinder front head or the nitrogen filling valve is leaking, the leakage may be detected by covering the head with a coating of grease and observing the air bubbles.

j. An air relief valve (fig. 32) is provided in the counterrecoil cylinder front head to relieve vacuum and to allow air, trapped in the cylinder, to escape when the gun is fired. The four small holes in the

DESCRIPTION AND FUNCTIONING OF CARRIAGE

respirator, in the center of the counterrecoil cylinder front head, must be kept clean for this purpose.

17. TOP CARRIAGE

a. The top carriage (fig. 33) is a heavy steel casting having two upright arms which form a yoke. The upper ends of these arms support

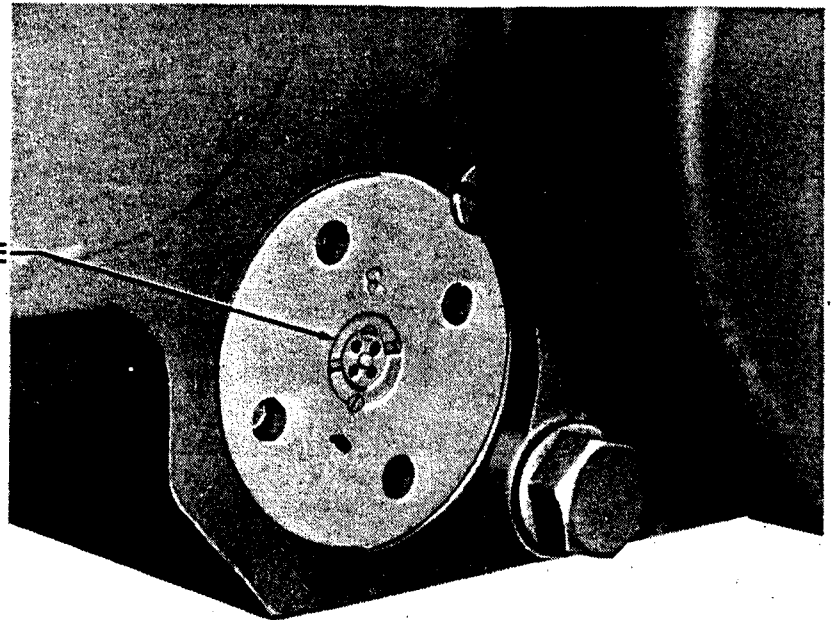

RA PD 37596

Figure 32—Air relief valve in counterrecoil cylinder front head

the trunnions of the cradle. In order to encircle the trunnions completely, trunnion bearing caps are provided and are assembled to recesses machined in the upright arms. The connecting rod for the variable recoil mechanism is fastened to the front of the left upright arm of the top carriage.

b. The elevating worm (fig. 33) revolves with its shaft, which is carried between bushings mounted in fins inside the top carriage. The elevating worm shaft is driven by the elevating bevel pinions in the elevating bevel pinion housing.

c. The handwheels (fig. 34), driving gears and shafting of the elevating and traversing mechanism are mounted on the top carriage, and are operated from the left side. The gearing is inclosed in the sighting gear casing, which is mounted into a depression in the top carriage. The sighting gear casing is provided with a sighting gear casing cover.

d. The traversing worm (fig. 35) is mounted between two lugs on the lower outside front of the top carriage. The traversing worm shaft is

MODIFICATIONS  
to battery without

COUNTERRECOIL  
FILLING AND  
DRAIN PLUGS

COUNTERRECOIL  
OIL INDEX

RA PD 37595

unt of counter-

ating piston from  
e oil. Should this  
uld bear against  
occur if the gun  
operator cylinder  
present.

$\frac{3}{16}$  inch (5 mm).  
re cylinder head  
omplished with  
valve set in the  
id. A filling and  
ad. For instruc-

the oil, it may  
the oil as it is  
nitrogen filling  
the head with a

interrecoil cyl-  
ped in the cyl-  
l holes in the

155-MM GUN MATERIEL, M1917, M1918 AND MODIFICATIONS

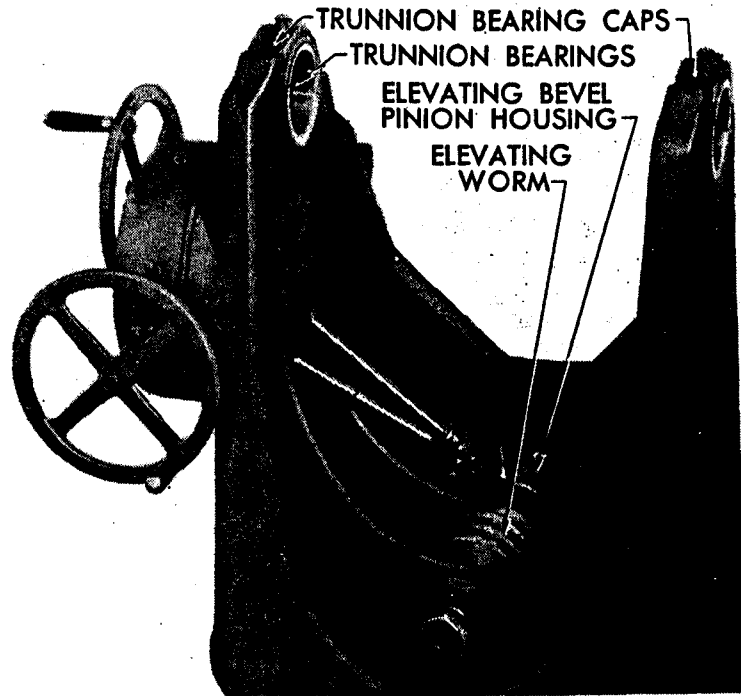

RA PD 37597

Figure 33—Top carriage showing elevating worm

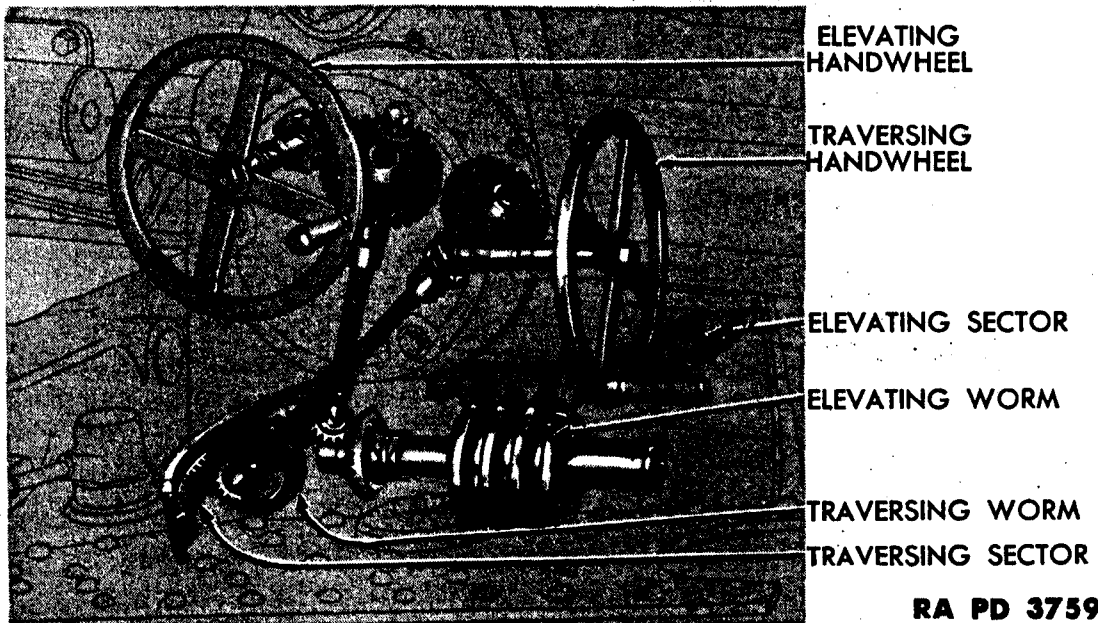

RA PD 37598

Figure 34—Phantom view of the elevating and traversing mechanism

driven by the traversing bevel pinions. The traversing bevel pinion housing is mounted to a lug at the left end of the traversing worm shaft.

e. The under surface of the top carriage (fig. 35), elliptical in shape, is machined and bears on a corresponding surface at the bottom carriage when the gun is fired. The top carriage is secured to the bottom carriage by a wide embracing lug on the latter, and by the pivot bolt assembly. (See also fig. 36.)

DESCRIPTION AND FUNCTIONING OF CARRIAGE

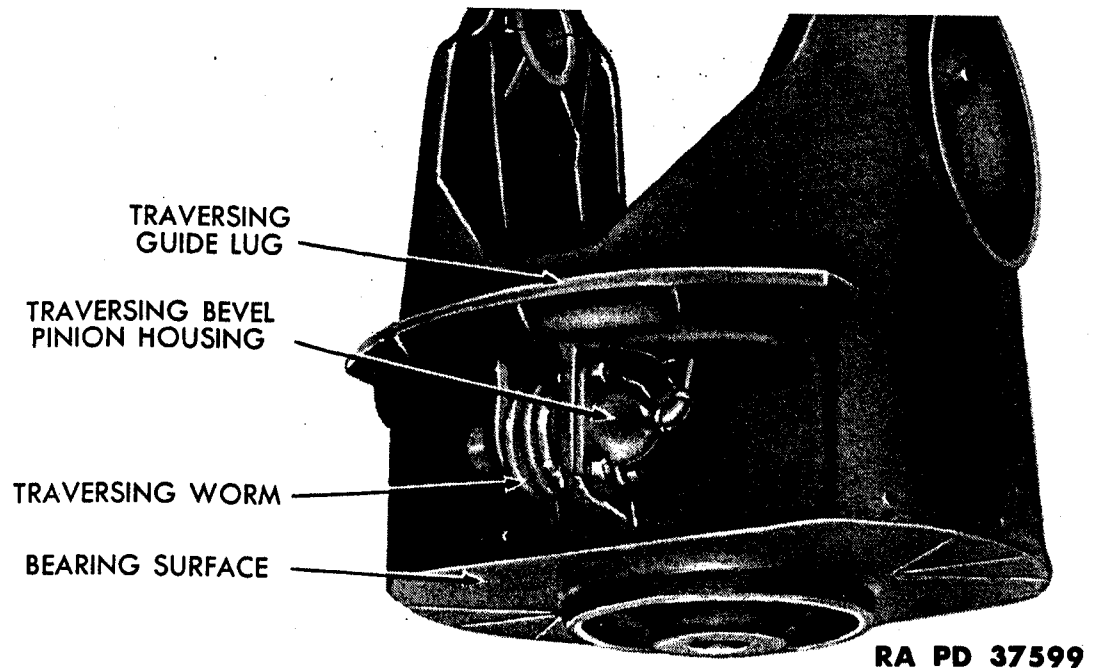

RA PD 37599

Figure 35—Top carriage showing bearing surface

f. To facilitate traversing, the weight of the top carriage, tipping parts and gun is borne on a small steel step (fig. 36), and not on the elliptical bearing surfaces of the top and bottom carriages. The step supports the weight through a column of eight Belleville springs assembled in the elastic suspension housing, bolted beneath the bottom carriage.

g. The force of recoil compresses these springs, permitting contact of the elliptical bearing surfaces as previously stated. By changing the position of the spring suspension adjusting nut (fig. 37), the space between

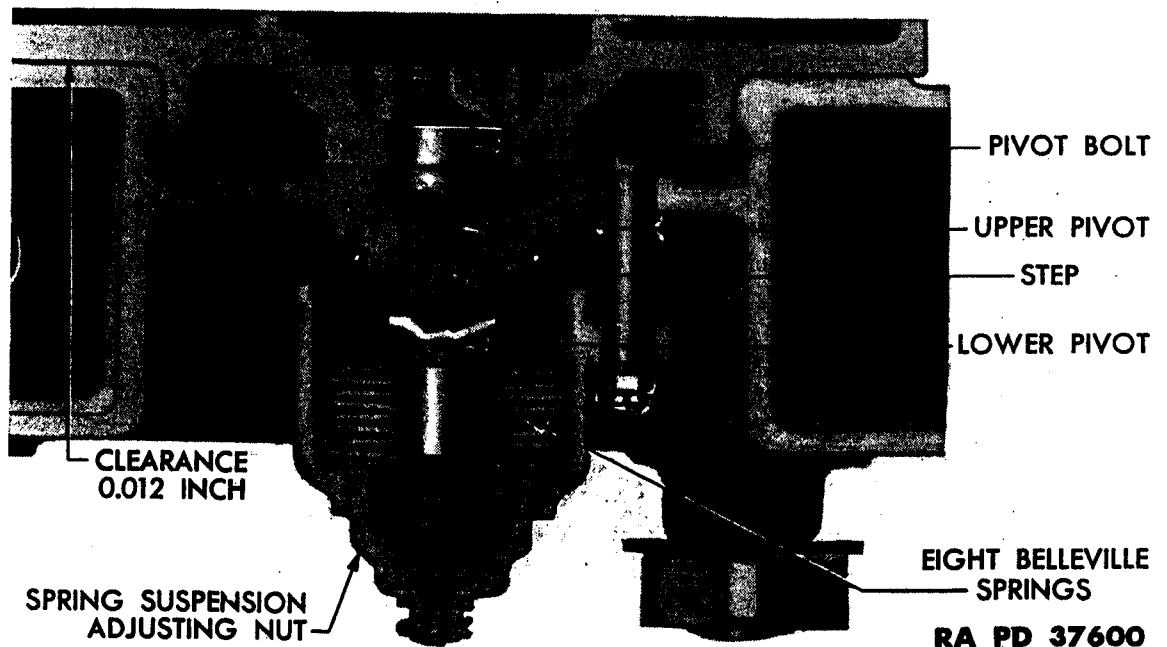

RA PD 37600

Figure 36—Sectional view of elastic suspension

## 155-MM GUN MATERIEL, M1917, M1918 AND MODIFICATIONS

these bearing surfaces may be varied within limits. The maximum clearance allowable is 0.012 inch and should be sufficient only to make traversing possible with a minimum of effort at the traversing wheel. For instructions in making the above adjustment, see paragraph 54 b.

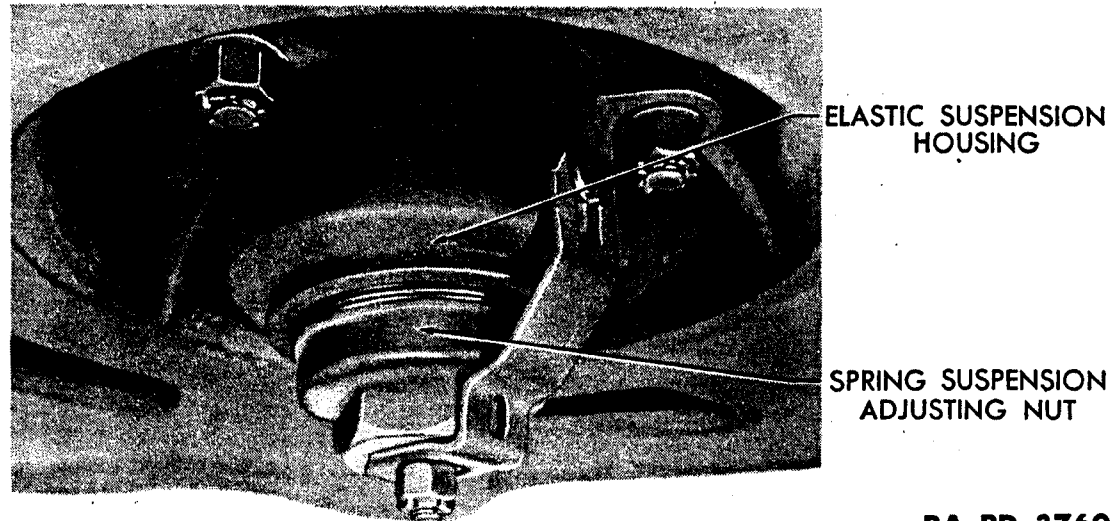

RA PD 37601

*Figure 37—Elastic suspension, viewed from below, showing adjusting nut*

## 18. BOTTOM CARRIAGE AND AXLE

a. The bottom carriage (fig. 38) supports the top carriage, which pivots about a vertical axis. The bottom carriage also provides hinge connections for the trails, and a traverse chamber for the gun axle. The back portion of the bottom carriage is extended to form the maneuvering lug. The traversing sector is screwed to the front inside wall of the bottom carriage.

b. The sides of the bottom carriage are extended as wings to the right and left rear. Each wing is bored to receive a trail hinge pin (fig. 39). The trails pivot on these pins in passing from traveling (closed) position to firing (spread) position. Trail locking bolts in the top forward parts of the wings are utilized to anchor the trails in the spread position.

c. On the 155-mm gun carriage, M2 and M3. (1) The gun axle bears the weight of the carriage. The front portion of the bottom carriage forms a traverse chamber through which the axle passes. The axle is pivoted on the axle pivot pin, which is inserted through mating holes in the bottom carriage and a hole in the axle.

(2) The front and rear walls of the axle chamber form guiding and bearing surfaces to control the axle's movement and resist horizontal thrust. The axle pivot pin permits a slight rocking movement of the bottom carriage to compensate for slightly different planes of the wheels

DESCRIPTION AND FUNCTIONING OF CARRIAGE

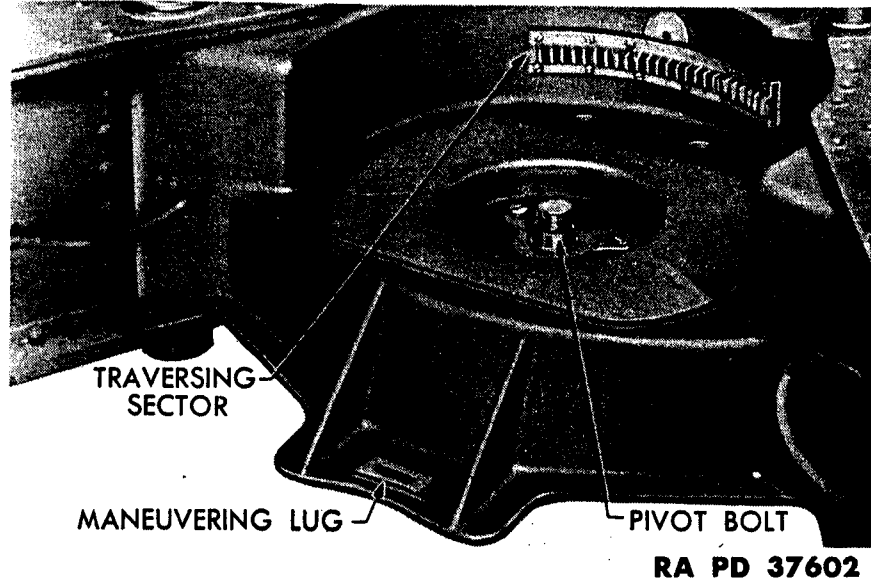

Figure 38—Bottom carriage showing bearing surface for top carriage

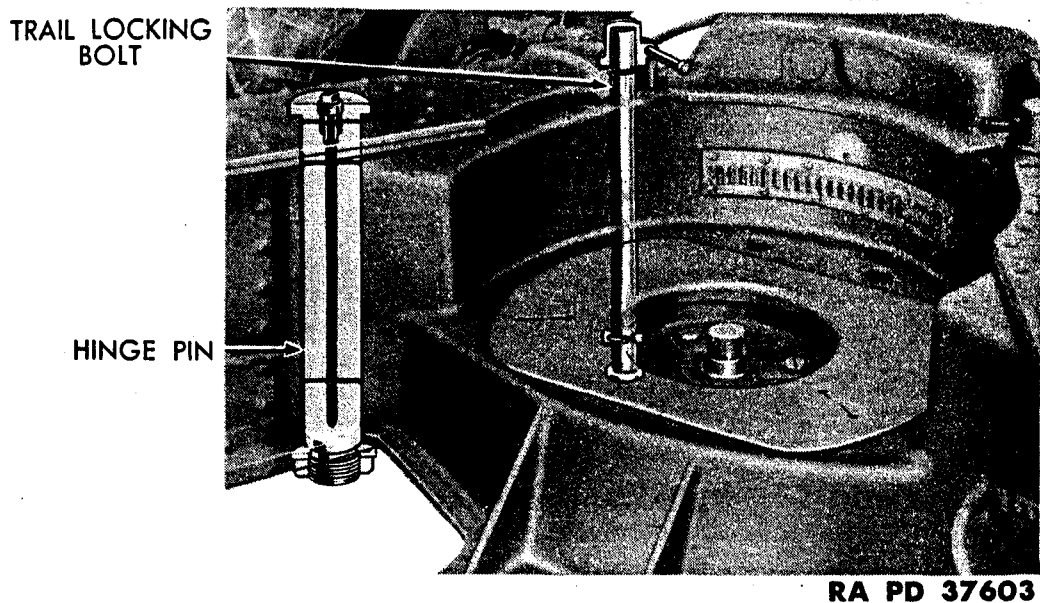

Figure 39—Cut-away of bottom carriage showing trail hinge pin and trail locking bolt

and spades when the gun is in battery, and for irregularities of road surface in traveling.

d. On the 155-mm gun carriages, M1917, M1918, M1917A1 and M1918A1. (1) The gun axle is connected to the carriage differently in traveling than when in firing position. In traveling, the bottom carriage rests directly on the gun axle spring, to which it is rigidly connected by four spring plate bolts. The gun axle spring is suspended from the axle by means of the lower spring shackles.

(2) To place the gun in firing position, the lower spring shackles

MODIFICATIONS

maximum clearance to make traversing wheel. For paragraph 54 b.

TRAIL LOCKING BOLT SUSPENSION HOUSING

TRAIL LOCKING BOLT SUSPENSION HOUSING

RA PD 37601

adjusting nut

carriage, which provides hinge pin axle. The maneuvering wall of the

wings to the hinge pin (fig. 39) (closed) top forward lead position.

) The gun passes the bottom carriage. The rough mating

guiding and horizontal movement of the wheels

## 155-MM GUN MATERIEL, M1917, M1918 AND MODIFICATIONS

are disconnected, the bottom carriage is lowered by means of jacks and the weight of the carriage is borne on the gun axle. The hole in the center of the axle is lined up with mating holes in the bottom carriage and the axle pivot pin is inserted through these holes to lock the axle and bottom carriage together.

## 19. TRAILS

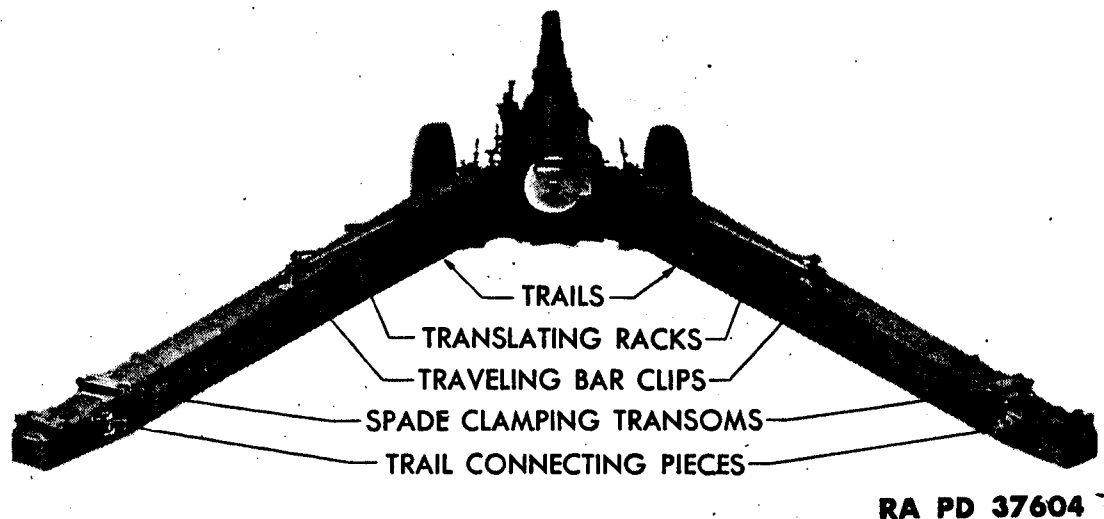

RA PD 37604

*Figure 40—Trails in spread position (without spades)*

a. The two trails (fig. 40) are composed of steel plates and trail ends riveted together to form box beams, which are hinged to the wings of the bottom carriage by the trail hinge pins. When spread, each trail forms an angle of  $30^\circ$  with the center of the carriage.

b. The outward swing of the trails is limited by the forward trail ends which come in contact with and encircle the trail locking bolts. The trail locking bolt nuts are screwed down into counterbored seats and lock the trails in the spread position.

c. Trail connecting pieces (fig. 40) are riveted on the inner sides of the trails near the rear ends. The trail connecting safety pin, inserted through the trail connecting pieces, holds the trails in the closed position. Other pieces, riveted to the top and bottom near the rear ends, are for alining, supporting and retaining the trails on the spades or the limber.

d. Spade seat plates, which form bearing surfaces for the spades, are riveted under the rear end of the trails. Two pairs of spades are provided: one for use in ordinary or soft ground (fig. 41), and the other for use in hard ground. Both types are built of plates and function as spades and floats. Each spade is equipped with swing bolts for securing it to the space clamping transoms.



**MODIFICATIONS**

means of jacks and  
The hole in the  
bottom carriage  
to lock the axle

**DESCRIPTION AND FUNCTIONING OF CARRIAGE**

e. In traveling, the spades for soft ground (fig. 41) are held on the top forward ends of the trails by spade retaining toggle turnbuckles. The spades for hard ground are carried on an accompanying vehicle.

f. The trail clamping transom (fig. 41), which lies across the trails when the gun is in traveling position, anchors the trails to the limber

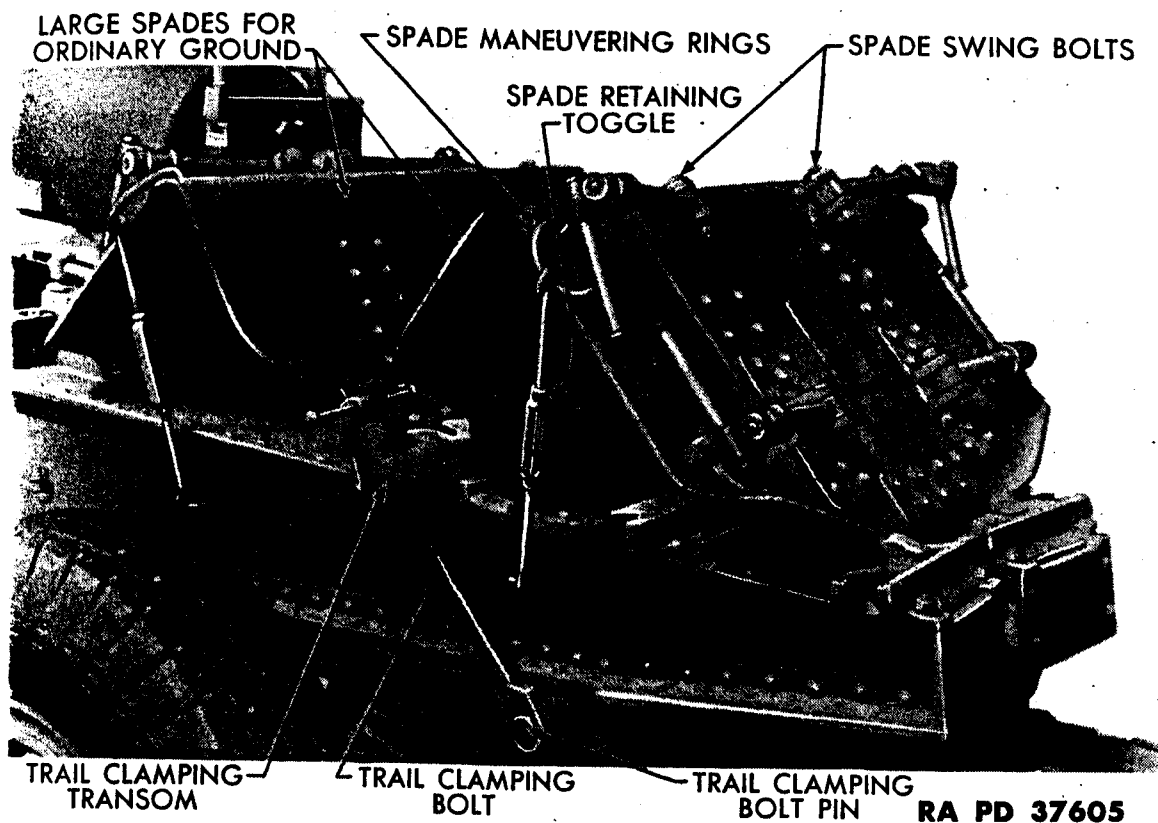

**Figure 41—Large spades in traveling position**

through the trail clamping bolts. The eye of each trail clamping bolt is slipped over the head of a trail clamping bolt pin on the limber and screwed down tightly to unite the carriage and the limber.

g. Translating racks (fig. 42), screwed to the tops of the trails, are for use in moving the gun to and from traveling position by means of the traveling lock. Attached to each trail about midway is a traveling bar clip. These clips lock the traveling lock (and the gun) to the trails, when the traveling lock is fastened to the gun in traveling position.

**20. WHEELS AND TIRES**

a. The wheels of the 155-mm gun carriage, M2 and M3, are of steel disk type, fitted with 16-ply, heavy-duty pneumatic tires, size 14.00—24, and bullet-resisting, 14.00—24 inner tubes.

b. The wheel disk, rim and ring assemblies are mounted to the

## 155-MM GUN MATERIEL, M1917, M1918 AND MODIFICATIONS

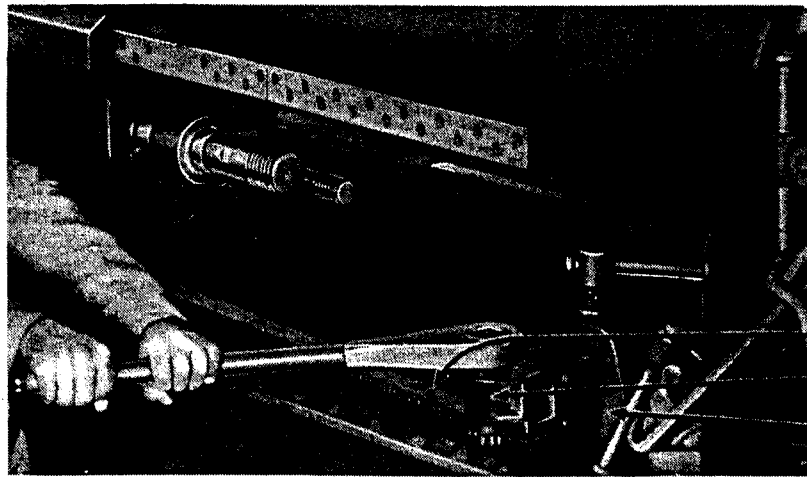

TRANSLATING RACK  
TRAVELING LOCK  
TRAVELING BAR CLIP

RA PD 37606

*Figure 42—Translating rack. Gun being racked into firing position*

carriage axle-hub and brake-drum assemblies by means of 10 disk and rim wheel studs, and held in place by disk and rim wheel stud nuts.

c. The weight of the carriage is carried on two tapered roller bearings in each hub. The bearings of each hub are alined by axle bearing adjusting shims and the axle bearing adjusting nut, and locked on the axle end by the axle end nut lockwasher and axle end nut. Foreign matter is kept from entering the outer ends of the hubs by hub caps which are fastened over the wheel centers.

d. The wheels of the 155-mm gun carriages, M1917 and M1918, have cast steel bodies and each wheel is equipped with two solid rubber tires between which is a tire separator ring of forged steel. They are carried on a bronze hub liner. A fiber gasket and a steel washer between the hub and the shoulder of the axle prevent the entrance of dirt and the loss of lubricant. Dirt and other foreign matter are kept from the outer hub by a hub cap which screws to the wheel center.

e. The wheels of the 155-mm gun carriages, M1917A1 and M1918A1, are the same as those described in the preceding subparagraph except that they have been modified for increased speed. They are equipped with antifriction roller bearings.

## 21. AIR BRAKES

a. The air brake equipment of the 155-mm gun carriages, M2 and M3, can be considered in two parts, for the purpose of easier understanding: 1. the air actuating system; 2. the brake operating mechanisms.

b. The principal parts of the air actuating system are: (1) The

MODIFICATIONS

DESCRIPTION AND FUNCTIONING OF CARRIAGE

air compressor, air strainer, governor, air pressure gage, brake valve, cutout cocks and hose couplings, all of which are located on the prime mover. The emergency air line and the service line cutout cocks are appropriately tagged on the prime mover.

(2) The relay-emergency valve (fig. 43), which relays and speeds up the brake action from the prime mover to the carriage, and produces an automatic brake application in case of break-in-two between the prime mover and the carriage.

(3) The reservoir (fig. 43), stores air for brake application on the carriage, both for service and for emergency brake applications. The reservoir is equipped with a drain plug at the bottom which permits drainage of moisture, and a cock at one end to relieve pressure in the reservoir when brakes become locked. The reservoir is mounted just below the relay-emergency valve.

(4) The two air lines (fig. 44), service and emergency, are continuous throughout the train. Both are equipped with the necessary couplings, connections, clips and fittings.

(5) Two brake chambers (fig. 45) one for each gun carriage wheel brake, which actuate the mechanism to apply the brakes. The brake chambers are of stud mounting type and are mounted to the gun axle by means of brackets.

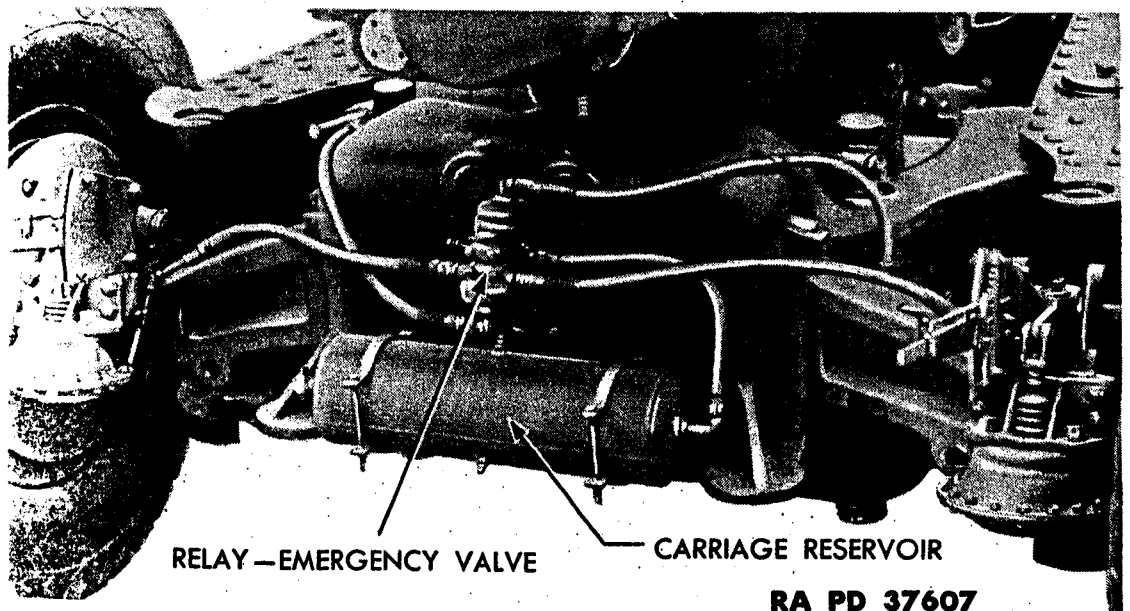

RA PD 37607

Figure 43—Relay-emergency valve and carriage air reservoir

TRANSLATING RACK  
LEVELING LOCK  
LEVELING BAR CLIP

RA PD 37606

g position  
of 10 disk and  
1 stud nuts.

red roller bear-  
y axle bearing  
locked on the  
foreign matter  
caps which are

M1917 and  
ed with two  
f forged steel.  
a steel washer  
e entrance of  
tter are kept  
center.

1917A1 and  
ubparagraph  
1. They are

rriages, M2  
asier under-  
mechanisms.

(1) The

155-MM GUN MATERIEL, M1917, M1918 AND MODIFICATIONS

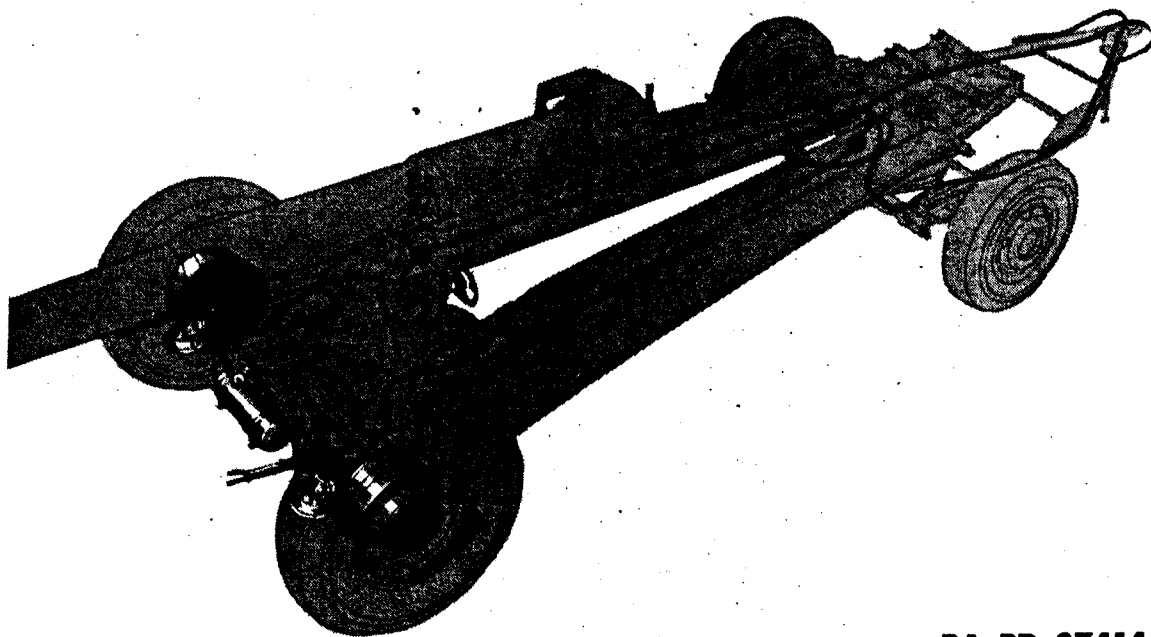

RA PD 37414

Figure 44—Service and emergency air lines on carriage and limber

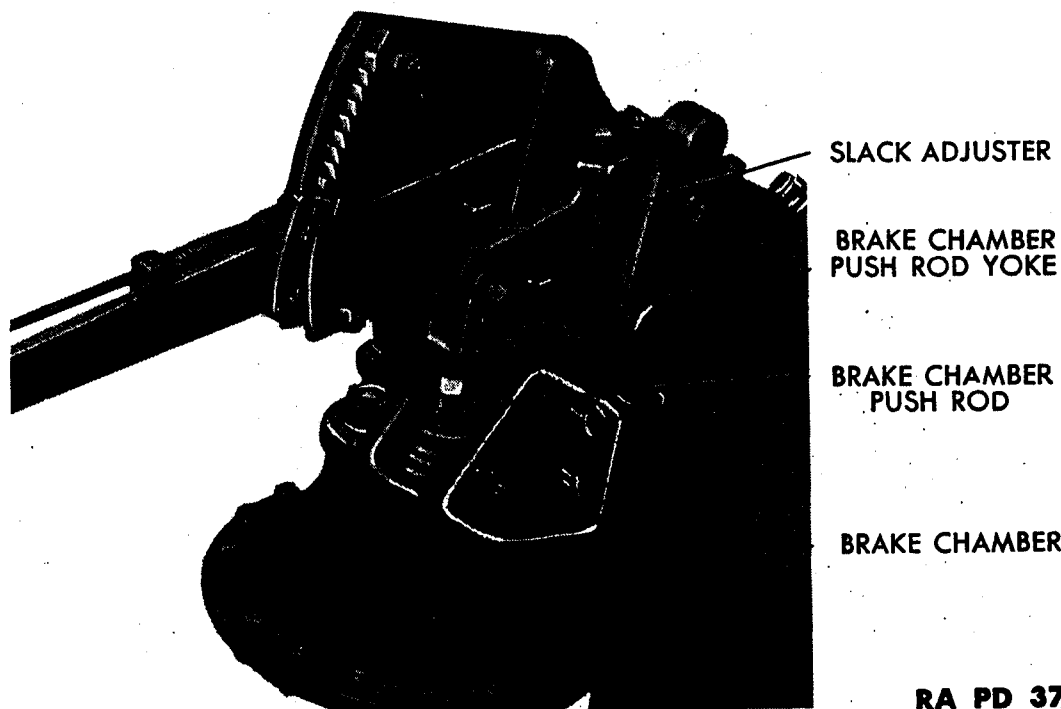

SLACK ADJUSTER

BRAKE CHAMBER  
PUSH ROD YOKE

BRAKE CHAMBER  
PUSH ROD

BRAKE CHAMBER

RA PD 37609

Figure 45—Wheel air brake chamber, push rod and slack adjuster

(6) Two slack adjusters, one for each brake mechanism, which provide a quick and easy method of brake adjustment. The slack adjuster connects the brake chamber push rod to the brake cam shaft (fig. 45).

c. The principal parts of the brake mechanism are:

(The following letters designate parts in fig. 46)

MODIFICATIONS

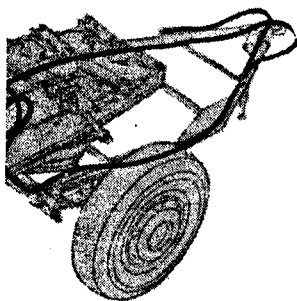

DESCRIPTION AND FUNCTIONING OF CARRIAGE

The brake drums (not shown) against which the brake linings are applied by the brake shoes to resist the turning of the wheels.

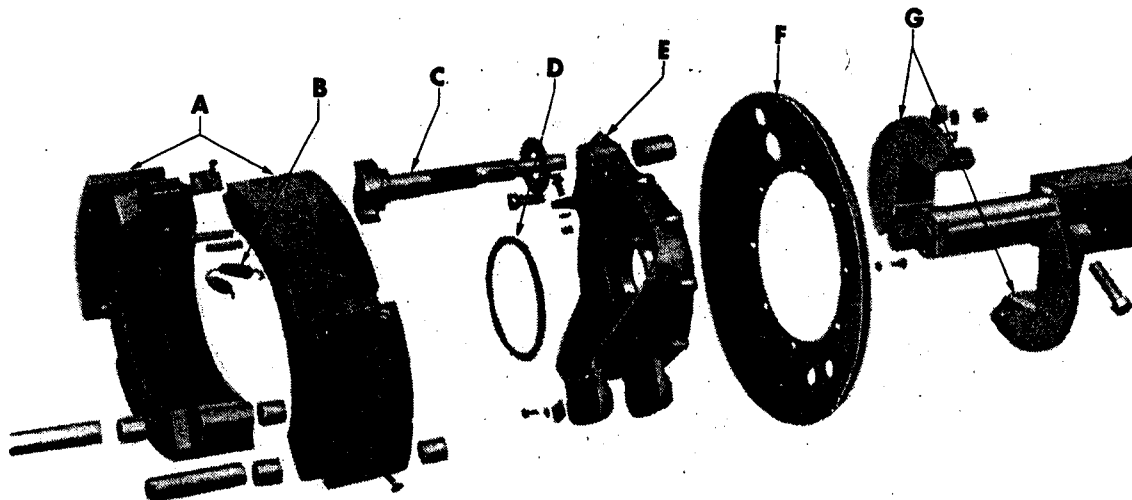

Figure 46—Exploded view of wheel braking mechanism of 155-mm gun carriages M2 and M3

- A Two brake shoes assembled in each brake drum, which expand to apply the brake linings to the brake drum.
- B The brake shoe springs, which draw the brake shoes away from the brake drums when the brakes are released.
- C The brake cam shaft, the cams of which expand the brake shoes to apply the brakes.
- D The oil slinger in the brake spider, which protects the brake linings from oil.
- E The brake spider, which serves as a foundation for the brake cam shaft and the brake shoes.
- F The brake spider shield, which protects the brake mechanism from water, mud, sand and other foreign matter thrown by the wheels.
- G The brake spider adapter assembly, by means of which the brake assembly is mounted on the gun axle.

The necessary pins, plates, sleeves, bolts, washers, and nuts, which are required to make the whole a functioning unit.

22. AIR BRAKE FUNCTIONING

a. Air Lines. (1) The service air line provides air pressure to operate the relay portion of the relay-emergency valve and actuate all service brake applications.

RA PD 37414

RA PD 37610

and limber

CK ADJUSTER

KE CHAMBER  
H ROD YOKE

KE CHAMBER  
JSH ROD

KE CHAMBER

RA PD 37609

adjuster

ism, which  
ack adjuster  
ft (fig. 45).

**155-MM GUN MATERIEL, M1917, M1918 AND MODIFICATIONS**

(2) The emergency air line keeps the gun carriage reservoir charged at all times. The reservoir, in turn, supplies the compressed air, which actually makes all brake applications.

**CAUTION:** In making all air line hose couplings between vehicles, the flexible hoses must be crossed over each other or the brakes will be locked.

(3) When the materiel is not equipped with air strainers, especial care must be exercised to keep sand and dust from entering the system.

**b. Filling the Reservoir.** (1) When the gun carriage air lines are connected to the prime mover and the cutout cocks are opened, air passes through the emergency line and enters the bottom of the lower or emergency portion of the relay-emergency valve (fig. 47). It raises the lower diaphragm, breaking the service seal, and flows upward to the gun carriage reservoir, building up a pressure equal to the pressure in the prime mover's reservoir.

(2) With pressures on both sides of the lower diaphragm thus equalized, the emergency valve spring holds the diaphragm up to close the emergency seal. It also holds the emergency valve away from its seat for the free passage of air for service brake applications.

**c. Service Brake Application.** (1) When the brakes are applied, pressure is introduced into the top or relay portion of the relay-emergency valve (fig. 47). This deflects the upper diaphragm downward, sealing the exhaust port and unseating the supply valve, allowing reservoir pressure to pass upward around its stem and thence past the unseated emergency valve to the brake chambers, applying the brakes.

(2) When brake chamber pressure has built up equal to that on top of the upper diaphragm, the supply valve spring forces the supply valve up to its seat to close off further air from the reservoir. This movement still leaves the exhaust sealed by the diaphragm. If a greater application is made at the brake valve, these actions are repeated to increase the pressure accordingly.

(3) If the brake valve is partially released, the drop in pressure above the upper diaphragm allows the greater brake chamber pressure beneath it to lift the diaphragm, breaking the exhaust seal and passing sufficient brake chamber pressure to equal the service line pressure. Then, the diaphragm is again deflected downward to prevent further exhaust. Complete release allows all the brake chamber pressure to escape, leaving the valve in the release position.

**d. Emergency Brake Application.** (1) Should the limber or gun carriage break away from the prime mover, or the emergency air

DESCRIPTION AND FUNCTIONING OF CARRIAGE

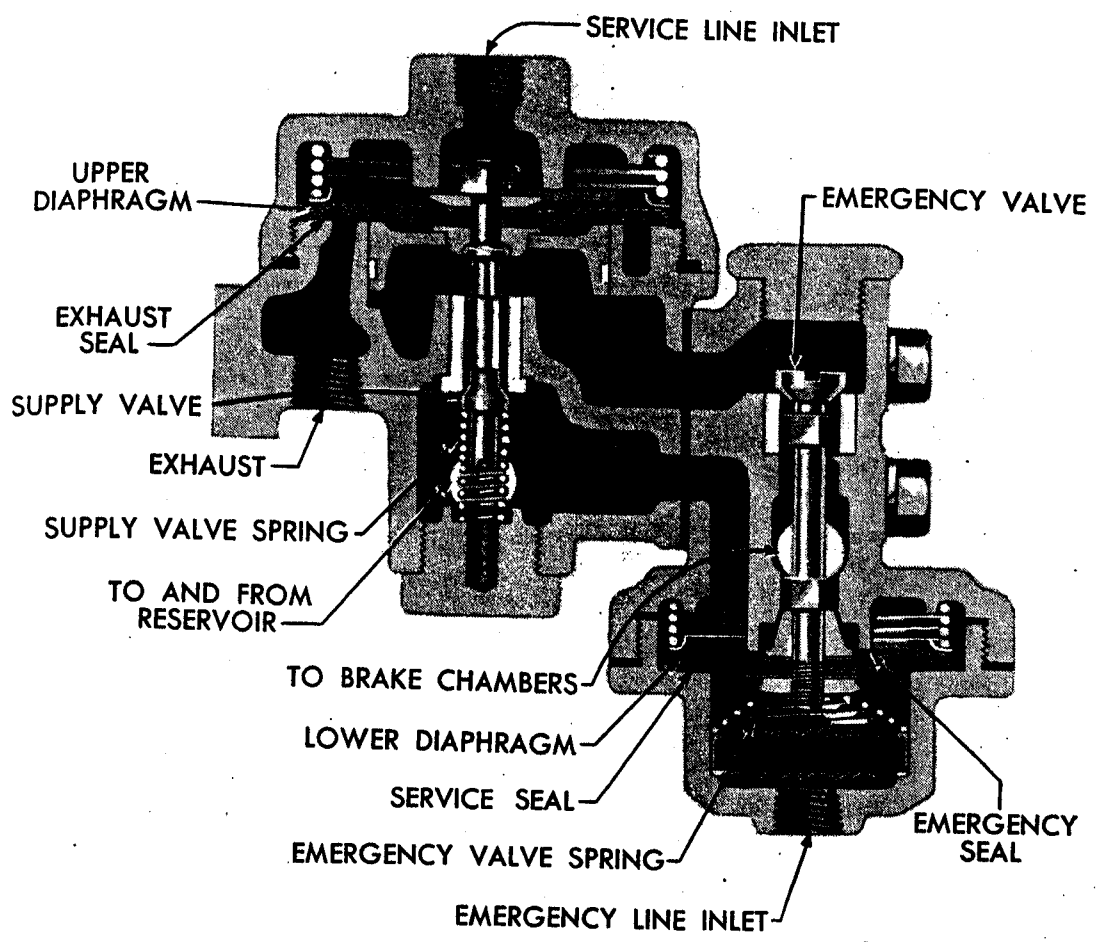

RA PD 37611

Figure 47—Sectional view of emergency relief valve

line hose burst, the sudden reduction in pressure will remove the pressure from below the lower diaphragm in the relay-emergency valve (fig. 47).

(2) The result will be that the pressure from the gun carriage reservoir will act upon the upper side of the lower diaphragm, deflecting it downward. This will break the emergency seal and permit air from the gun carriage reservoir to flow upward around the emergency valve stem and thus produce an emergency application of the gun carriage brakes.

(3) At the same time, the emergency valve will be drawn downward to its seat by the movement of the diaphragm, cutting off any opportunity for air to escape by way of the exhaust. Also, the service seal will be closed so that the brakes will be held applied without leakage through the ruptured emergency line.

e. Brake Chambers. (1) The brake chambers (fig. 48) comprise two dished plates between which is a diaphragm made of oil proof rubberized fabric. The diaphragm is airtight and responds to slight variations in pressure. The diaphragm divides the chamber into two halves, known as the non-pressure and pressure sides.

## 155-MM GUN MATERIEL, M1917, M1918 AND MODIFICATIONS

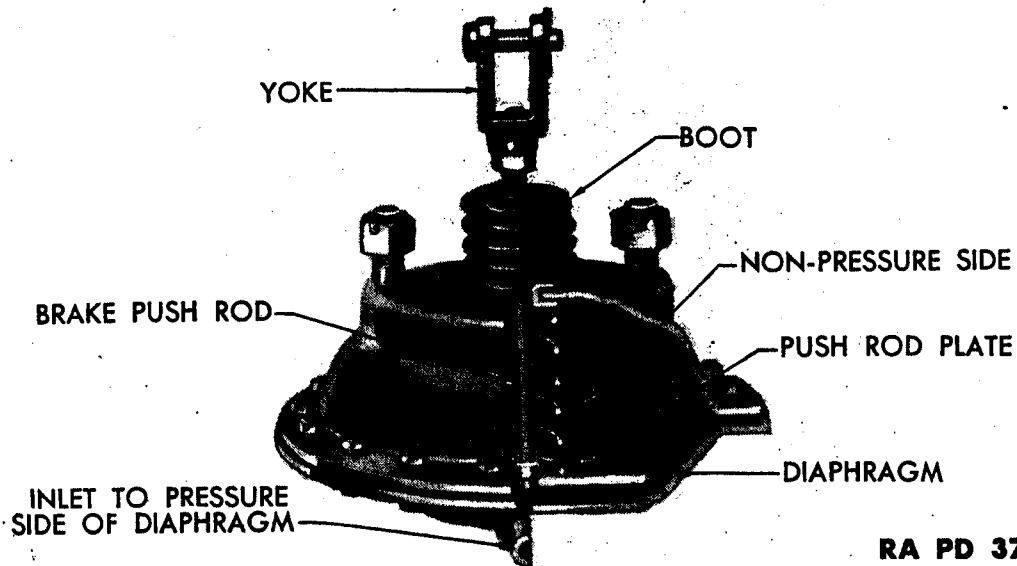

RA PD 37612

**Figure 48—Cut-away view of brake chambers**

(2) A spring on the non-pressure side of the diaphragm holds a push rod plate against the diaphragm in its release position, forcing the diaphragm into the pressure side. When compressed air enters the pressure side, it forces the diaphragm and push rod plate toward the non-pressure side.

(3) A brake push rod (fig. 48) is fastened to the push rod plate, and power exerted against the brake chamber diaphragm and push rod plate forces the push rod out. The yoked outside end of the push rod is hinged to the slack adjuster, which acts as a lever to rotate the brake camshaft. This, in turn, causes the cams to spread the brake shoes, expanding them to apply the brake linings to the braking surface inside the brake drum.

### 23. ELECTRIC BRAKES

a. On the 155-mm gun carriages, M1917A1 and M1918A1.

(1) The electric brakes are actuated from the prime mover by a rheostat-like controller, which releases current to energize magnets in the wheel brake drums and causes them to cling to and rotate with their armatures until lugs on the armatures force the cam levers against the open ends of the brake bands. This expands the brake bands against the brake drums and stops the wheels.

(2) When the brakes are released at the controller, the current is shut off, the magnets release the armatures and are returned to their original positions by the magnet return springs, and the brake bands are contracted by the brake band return springs and are pulled away from the drums.

b. The wiring is from the terminals on the carriage wheel brakes through flexible and rigid conduit to the jumper cables, which are



DESCRIPTION AND FUNCTIONING OF CARRIAGE

inserted in the coupling sockets on the limber. All wire connections are made by soldered joints.

c. A safety switch is provided to set the brakes on the carriage in the event of a break-away between the prime mover and the carriage. A safety switch chain connects the switch with the prime mover. If a break-in-two occurs and the flow of electric current from the prime mover is broken, the safety switch lever is pulled by the safety switch chain. This causes a connection to be made with the auxiliary dry cell batteries on the limber, energizes the magnets in the brakes and sets the brakes.

d. The brake operator's seat was eliminated when the carriage was modified for electric brakes.

24. HAND-OPERATED MECHANICAL BRAKES

a. On the 155-mm gun carriages, M1917 and M1918. The hand-operated mechanical brakes are actuated by cables from the brake operator's seat, which is bolted to the trail clamping transom. The trail clamping transom rests on the trails over the limber.

b. The brakes are operated by a lever at the operator's right. The brake cable is provided with connections to make it continuous from one brake mechanism up to the brake lever and back to the other brake mechanism. It passes through the tubular brake lever shaft and over brake cable rockers at each end of the shaft.

c. When the brake lever is unlatched and pulled to the rear, the cable winds up on the brake cable rockers and puts tension on the cable to apply the carriage brakes. If this tension is unequal, the cable slips in the shaft to equalize the pull. The brake lever latch pawl automatically engages the brake quadrant to hold the brakes in the applied position.

25. HAND BRAKES

a. On the 155-mm gun carriages, M2 and M3. A hand brake lever (fig. 49) is provided for each carriage brake. The hand brake lever is hinged on the brake cam shaft. An extension, welded to side of the hand brake lever near its rear end, is positioned under the slack adjuster. When the lever is lifted, this extension lifts the slack adjuster, causing the brake camshaft to rotate and apply the brakes.

b. The hand brake lever is provided with a spring loaded hand grip lever (fig. 49) connected to a hinged hand brake lever latch. When the hand brake lever is lifted to apply the brake, the hand brake lever latch is engaged in the teeth of a latch plate to hold the brake in application.

c. On the 155-mm gun carriages, M1917A1 and M1918A1. When the hand brake lever is moved to apply the brake, the crank end

MODIFICATIONS

PRESSURE SIDE

ROD PLATE

FRAGM

RA PD 37612

Frangm holds a  
on, forcing the  
nters the pres-  
ward the non-

rod plate, and  
push rod plate  
rod is hinged  
ake camshaft.  
panding them  
brake drum.

d M1918A1.  
y a rheostat-  
in the wheel  
ir armatures  
e open ends  
t the brake

the current is  
ed to their  
e bands are  
away from

heel brakes  
which are

## 155-MM GUN MATERIEL, M1917, M1918 AND MODIFICATIONS

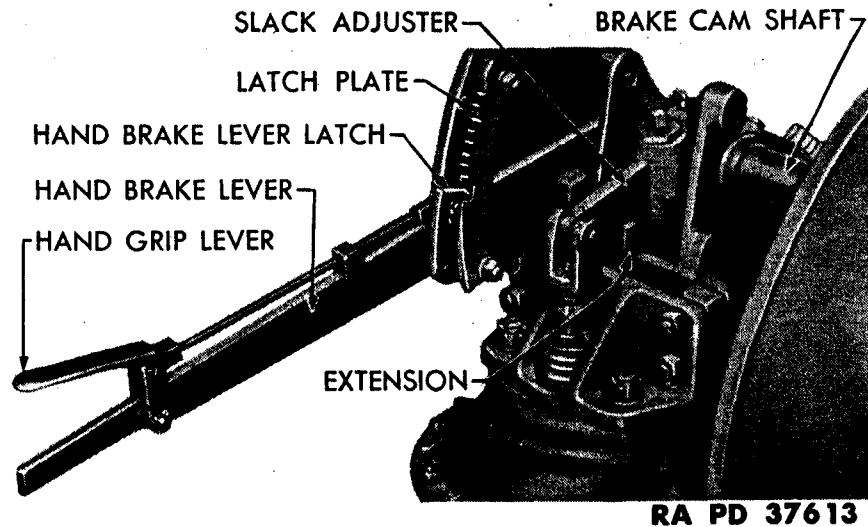

Figure 49—Hand brake lever and connections on the 155-mm gun carriages, M2 and M3

of the hand brake shaft is forced against the rolls of the brake band, causing the brake band to expand against the brake drum and hold the wheel. The teeth of the rack are engaged by the spring actuated plunger of the hand brake lever to hold the brake in application. To release the brake, push down on the plunger knob on the top of the hand brake lever. The tension of the brake band return spring will force the thrust lever and brake band to their original positions.

## 26. 155-MM GUN SEACOAST EMPLACEMENT

When the 155-mm gun materiel, M1917, and M1918 is used by the coast artillery on the 180° emplacement, the spade seats are removed and those of different design applied. If these guns are required for use in the field later, no change will be necessary, as the spades may be used with the new spade seat plates.

MODIFICATIONS

AM SHAFT

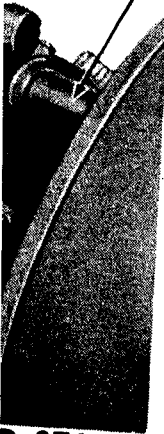

D 37613  
5-mm gun car-

the brake band,  
um and hold the  
actuated plunger  
1. To release the  
the hand brake  
force the thrust

3 is used by the  
re removed and  
d for use in the  
y be used with

Section IV

DESCRIPTION AND FUNCTIONING OF LIMBER

	Paragraph
Heavy carriage limber, general . . . . .	27
Axle . . . . .	28
Springs . . . . .	29
Fifth-wheel . . . . .	30
Drawbar . . . . .	31
Air line hose and connections . . . . .	32
Wheels, tires and hub assemblies . . . . .	33
155-mm gun carriage limbers, M1917 and M1918 . . . . .	34
155-mm gun carriage limbers, M1917A1 and M1918A1 . . . . .	35
To attach trails to limber . . . . .	36

27. HEAVY CARRIAGE LIMBER, M3, GENERAL

The heavy carriage limber, M3 (fig. 50), has been especially designed for high speed movement. It is equipped with pneumatic tires and a fifth-wheel type of steering.

28. AXLE

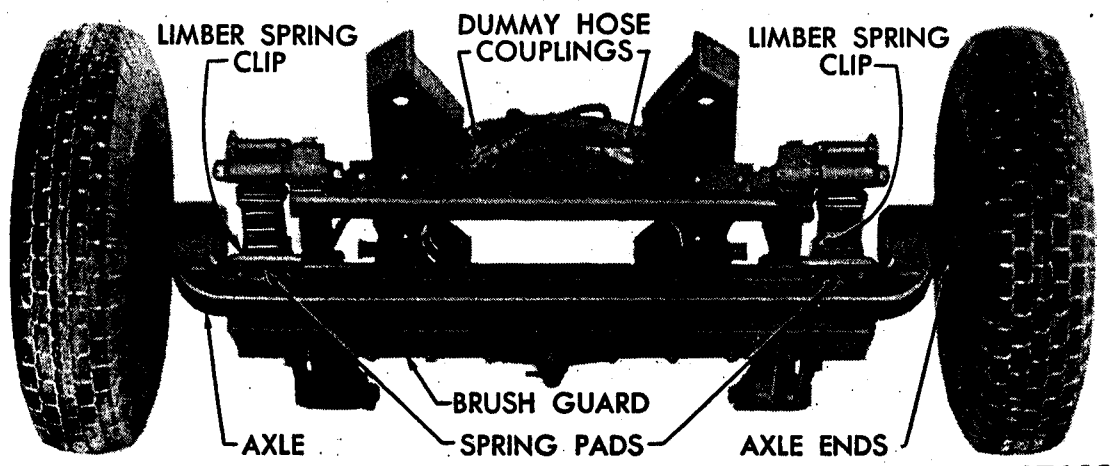

Figure 50—The axle of the heavy carriage limber, M3

The limber axle (fig. 51) is a steel forging. The axle body is I-sectional in form, terminating in right angle bends with boss ends horizontally

RA PD 23510

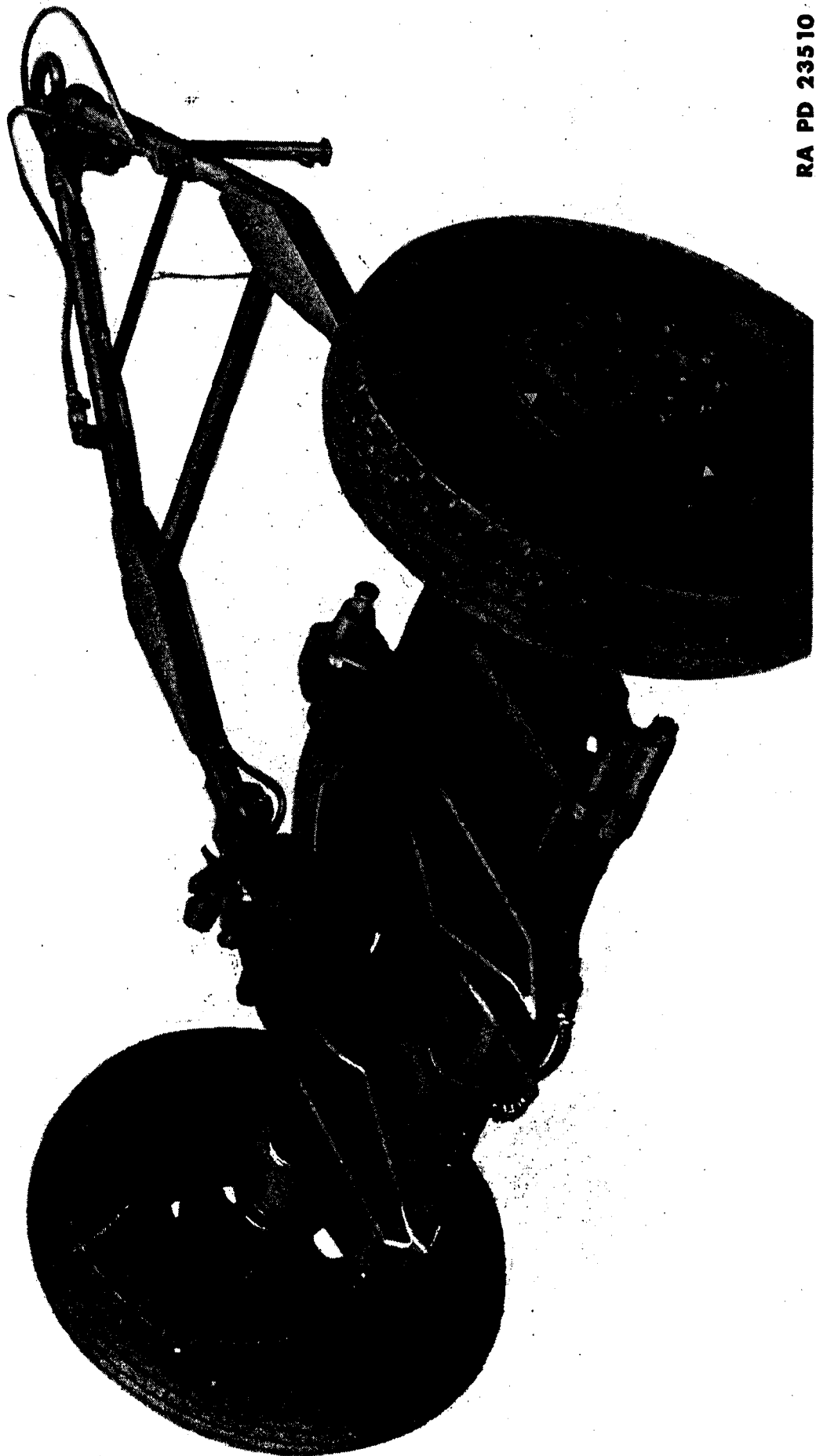

Figure 51—The heavy carriage limber, M3

**DESCRIPTION AND FUNCTIONING OF LIMBER**

bored for the axle ends or spindles. Two pads are provided on the axle body as seats for the springs and are drilled to receive the ends of the limber spring clips.

**29. SPRINGS**

a. The limber springs (fig. 52) are of semi-elliptic leaf type. Their leaves are maintained in proper relation by a centering bolt. An upper

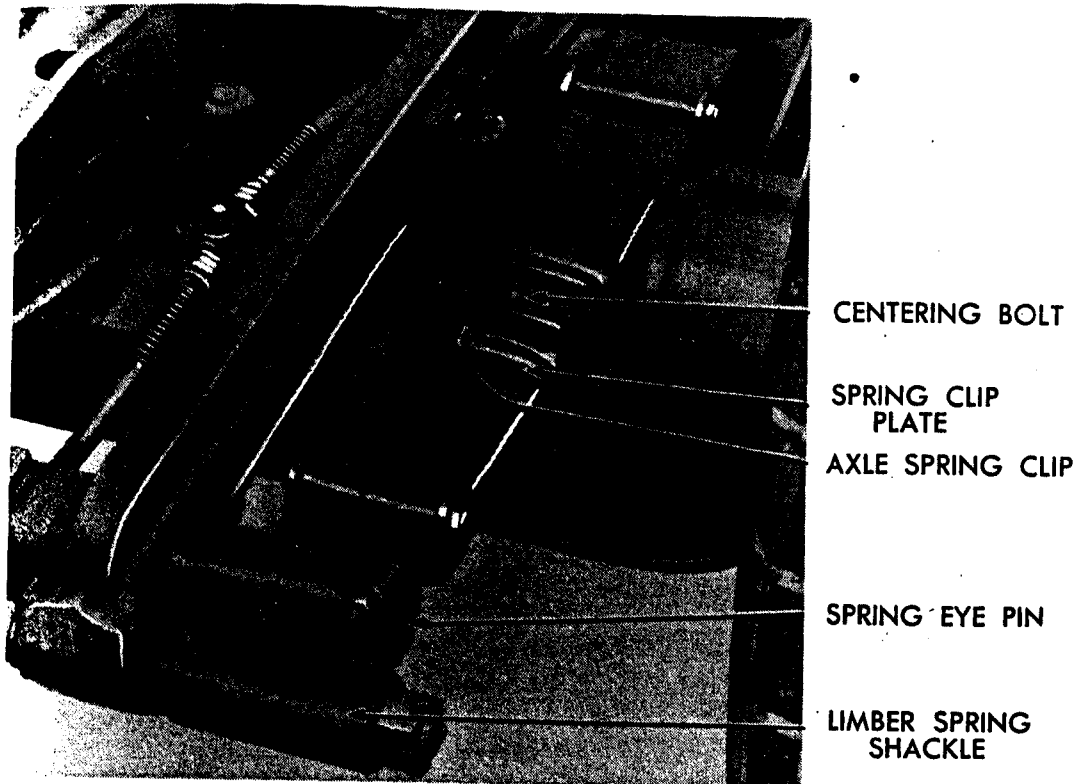

RA PD 37616

*Figure 52—One of the two springs of the heavy carriage limber, M3*

spring clip plate is assembled on top of each spring over the centering bolt, and holds in correct position the axle spring clips, which clamp the spring to the axle.

b. The main leaf of each spring is coiled to form a spring eye at both ends to receive the main leaf spring eye oilite bushings. The springs are attached to the spring brackets at their front ends by spring eye pins and at their rear ends through the limber spring shackles.

**30. FIFTH-WHEEL**

a. The fifth-wheel assembly permits the limber to pivot under the front ends of the trails to follow the movement of the drawbar.

MODIFICATIONS

RA PD 23510

*Figure 51—The heavy carriage limber, M3*

## 155-MM GUN MATERIEL, M1917, M1918 AND MODIFICATIONS

b. Front and rear crossmembers (fig. 53) are welded and riveted to the spring brackets and riveted to the fifth-wheel base which is carried upon them. Together, they form the spring support assembly. The manganese bronze fifth-wheel ring is bolted to the fifth-wheel base. The fifth-wheel trail rest ring floats on the fifth-wheel, which serves as its bearing. The fifth-wheel trail rest ring is encircled and held in position on the fifth-wheel by the fifth-wheel trail rest ring clamp.

c. Right and left fifth-wheel trail rests (fig. 53) are bolted to the fifth-wheel trail rest ring. The rear ends of the fifth-wheel trail rests are

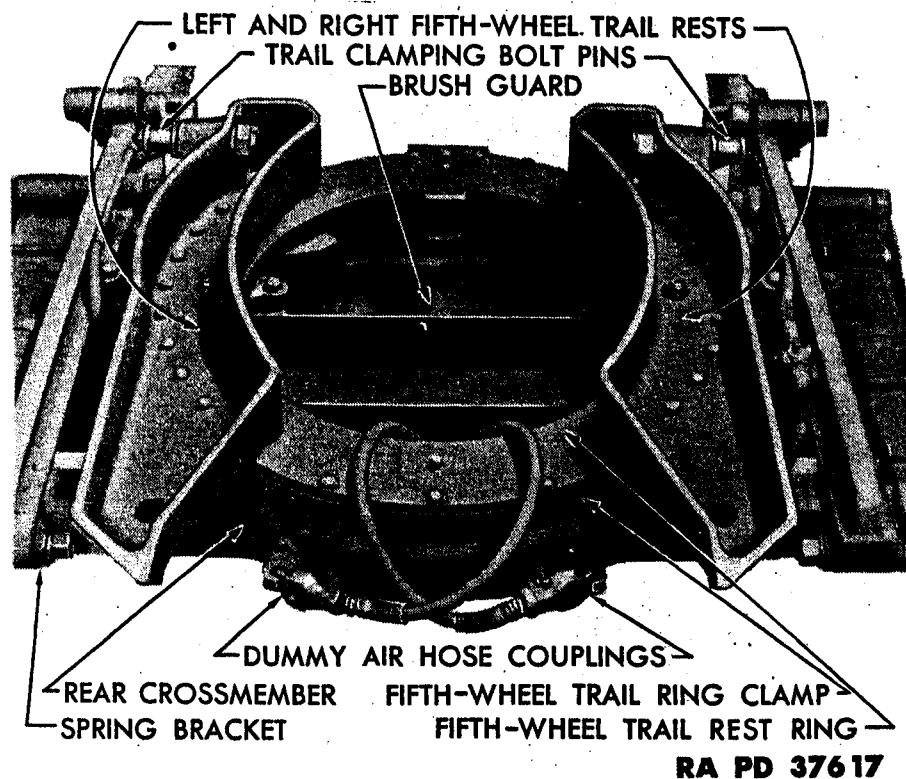

RA PD 37617

**Figure 53—Fifth-wheel and spring support assemblies**

welded and riveted to the under sides of the trails. They are pointed in shape and are beveled to receive the limber stops. Trail clamping bolt pins are located in bosses in the forward outside ends of the fifth-wheel trail rests.

d. A brush guard (fig. 53) of welded construction is bolted to the front under side of the spring support assembly. Dummy air hose couplings are located on the rear of the spring support assembly.

e. (1) The fifth-wheel locking bracket (fig. 54) is bolted to the front under side of the fifth-wheel trail rest ring assembly. The fifth-wheel locking pin is inserted through a hole in the front face of this bracket, into a hole bored in a boss on the front of the spring support assembly. The purpose of this pin is to maintain the alinement of the fifth-wheel trail rest ring assembly when the limber is detached from the trails of the carriage.

DESCRIPTION AND FUNCTIONING OF LIMBER

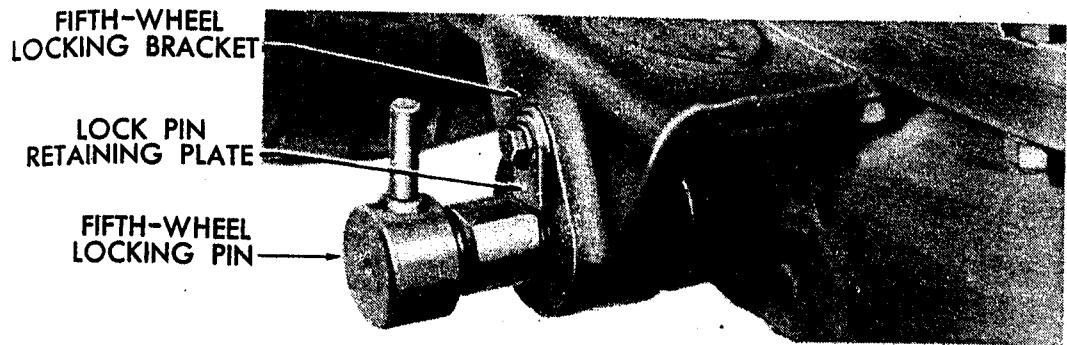

RA PD 37618

Figure 54—Fifth-wheel locking bracket and locking pin

(2) The fifth-wheel locking pin is tubular, except for one flattened side. The handle of the pin must be raised perpendicularly to bring this surface beneath the lower edge of the lock pin retaining plate. It can then be pulled out of or pushed into engagement. Turning the handle downward locks the pin in the desired retaining groove.

**CAUTION:** The fifth-wheel locking pin must be disengaged before the loaded limber is towed, or damage to the limber will result.

31. DRAWBAR

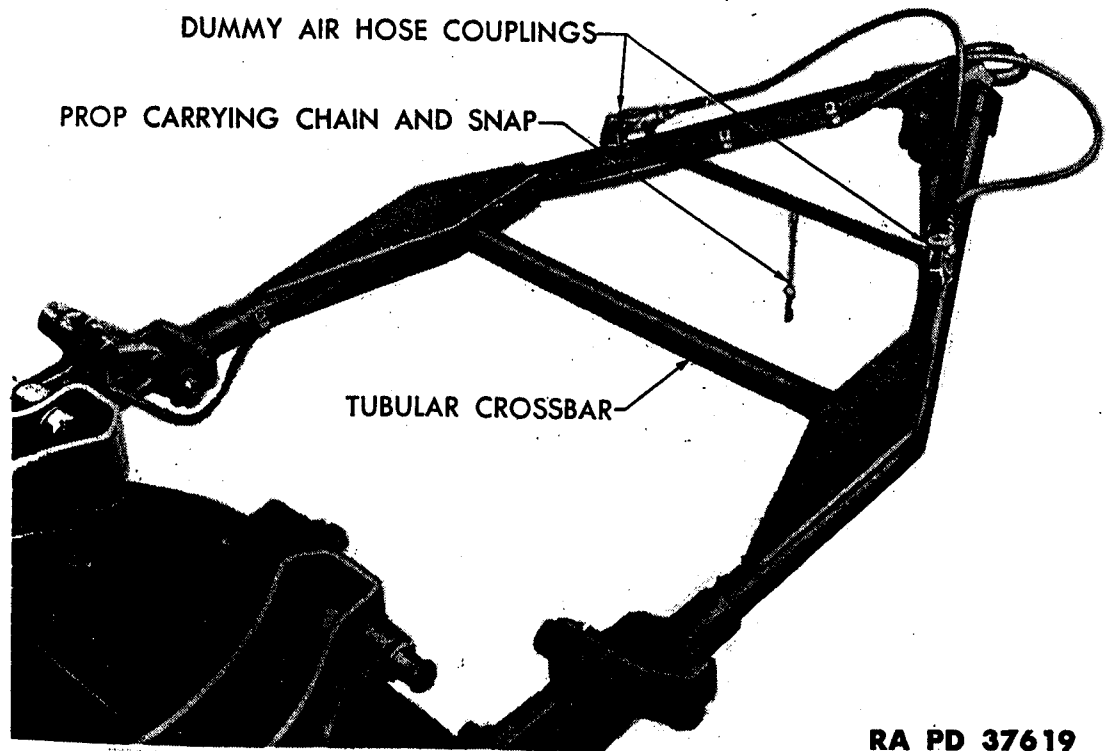

RA PD 37619

Figure 55—Drawbar assembly of the heavy carriage limber, M3

a. The drawbar (fig. 55) is A-shaped, built of steel forgings and tubing, and reinforced by plates welded on the top and bottom of the tube at the junction of the tubular crossbar. Dummy air hose couplings are located on top of the tubes near the prop carrying chain and snap plate.

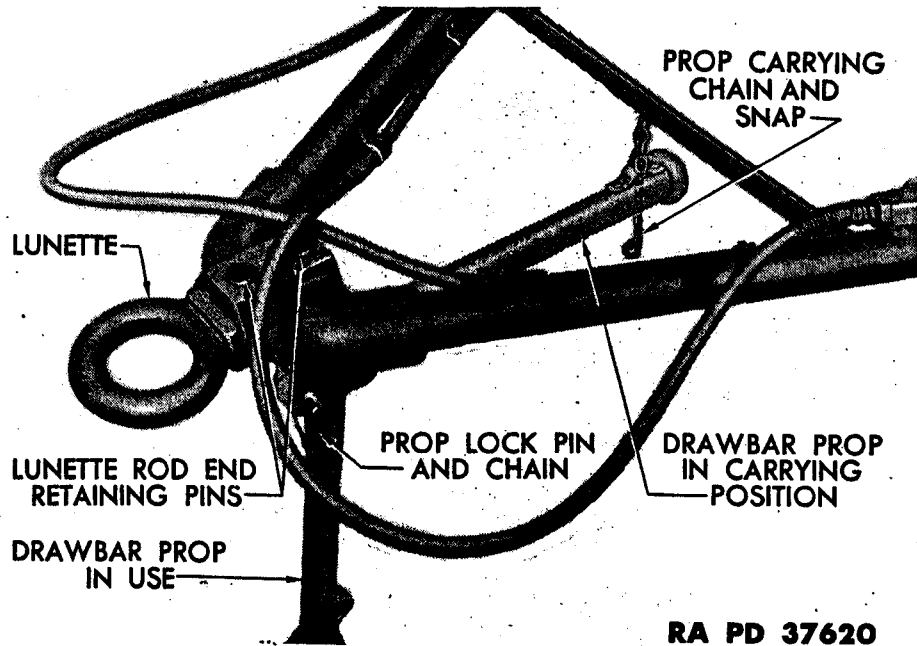

RA PD 37620

**Figure 56—Lunette and drawbar prop in use and in carrying position**

b. The lunette (fig. 56) is held in the drawbar end by two lunette rod end retaining pins. The drawbar prop is hinged to the under side of the drawbar end by the prop rod end hinge pin. When in use, the prop is held in vertical position by the prop retaining chain pin. In traveling, the prop is held horizontally by the prop carrying chain and snap assembly.

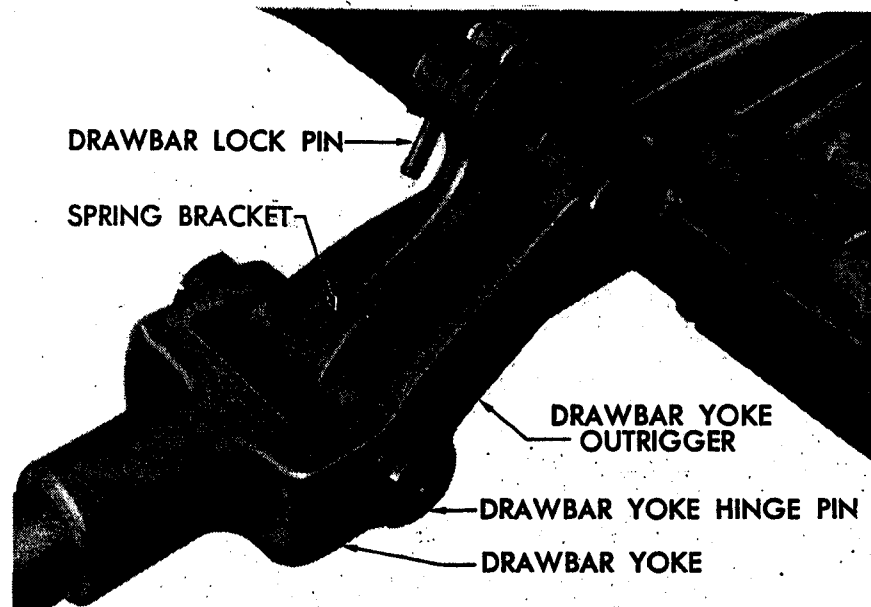

RA PD 37621

**Figure 57—Drawbar yoke and drawbar lock pins**

c. The drawbar assembly is attached to the limber by drawbar yokes and bushings in the front ends of the spring brackets (fig. 57). In traveling, these connections provide hinged joints which permit flexibility for negotiating rough ground.



**DESCRIPTION AND FUNCTIONING OF LIMBER**

(2) An angular outrigger on each drawbar yoke is provided to immobilize the flexibility of these connections when the limber is detached from the carriage. Drawbar lock pins (fig. 57) in the ends of the outriggers are inserted through holes drilled in the bosses on top of and near the front ends of the spring brackets. These pins have flattened top surfaces which must be faced upward to permit engagement and disengagement.

**CAUTION:** Both drawbar lock pins must be disengaged before the loaded limber is towed, or damage to the limber will result.

**32. AIR LINE HOSE AND CONNECTIONS**

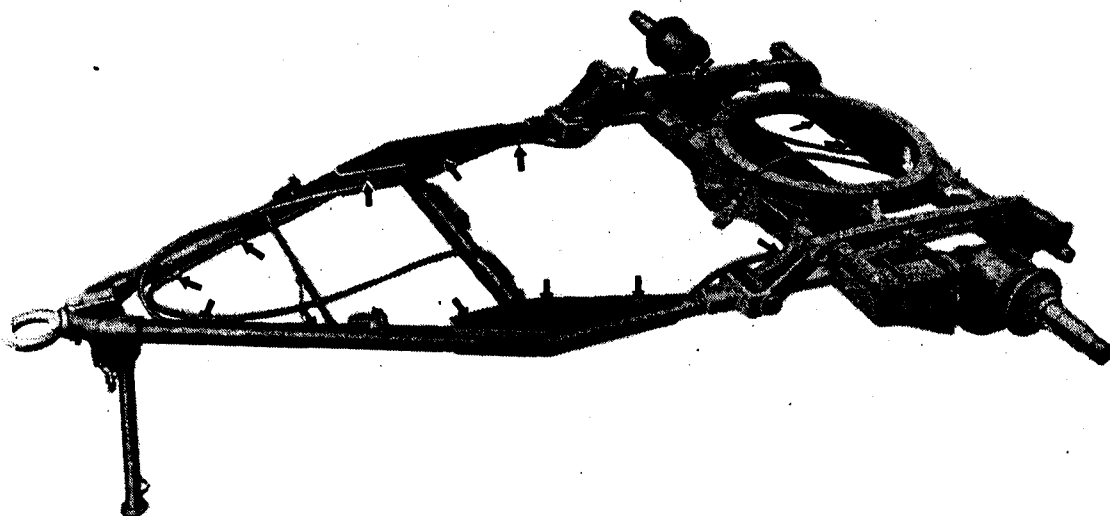

RA PD 23521

Figure 58—Air line hose and connections on heavy carriage limber, M3

Air line hose and connections (fig. 58) on the limber are for the purpose only of transmitting air pressure control to the air brakes on the carriage.

**33. WHEELS, TIRES AND HUB ASSEMBLIES**

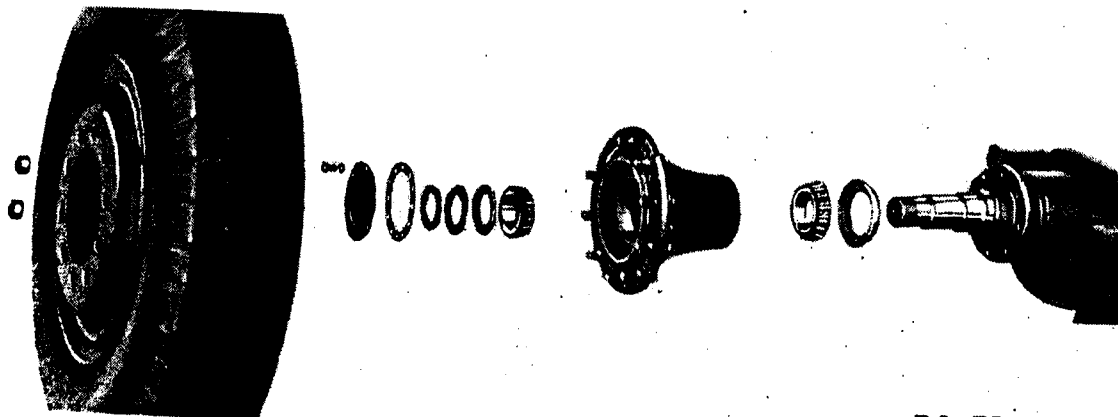

RA PD 37623

Figure 59—Wheel, tire and hub assembly of heavy carriage limber, M3

**MODIFICATIONS**

CARRYING  
PIN AND  
SNAP

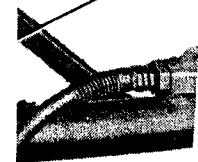

BAR PROP  
CARRYING  
POSITION

37620

Carrying position

held by two lunette  
pins on the under side of  
the limber in use, the prop  
is in use. In traveling,  
the prop is in the  
lunette snap assembly.



37621

37621

held by drawbar  
locks (fig. 57).  
This permits flexi-

**155-MM GUN MATERIEL, M1917, M1918 AND MODIFICATIONS**

a. The wheels of the heavy carriage limber, M3, are of steel disk type, fitted with 12-ply, heavy service pneumatic tires, size 11.00-20, (type B), and bullet resisting, 11.00-20 inner tubes. Inflation pressure, 70 pounds.

b. The wheel disk, rim and ring assemblies (fig. 59) are mounted to the limber axle hubs by means of ten disk and rim wheel studs in the outer flange of each hub and are held in place by disk and rim wheel stud nuts.

c. The weight of the limber is carried on two tapered roller bearings in each hub. The bearings in each hub are alined by the axle bearing adjusting nut and dowel, and locked in place by the nut and dowel washer and axle end nut. Foreign matter is kept from entering the outer ends of the hubs by hub caps, which are fastened over the wheel centers.

**34. 155-MM GUN CARRIAGE LIMBERS, M1917 and M1918**

a. **General.** The 155-mm gun carriage limbers, M1917 and M1918, have two steel bodied wheels carried on bronze bushings. Each wheel is equipped with two solid rubber tires. The wheels are interchangeable with those of the 155-mm gun carriage, M1917 and M1918. Steering is by means of a pole-type drawbar linked to the steering knuckles on the ends of a fixed axle. The hand brakes on the carriage are controlled by an operator who rides on a seat on the trails over the limber.

b. The I-section front axle is forked at the ends for the steering knuckle spindles. The axle is attached to the frame by two semi-elliptic, multiple leaf springs.

c. The spring leaves of each spring are maintained in proper relation by a centering bolt, a spring plate on top of the spring, which is assembled over the centering bolt, and two spring clips which clamp the spring to its seat on a pad on the axle. The springs are bushed at each end, and are attached to the front spring hangers of the frame by the spring eye pins, and to the rear spring hangers through the limber spring shackles.

d. The frame consists of two channel-shaped side rails joined at the front by a main steel casting, known as the forward transom and at the rear by the flanged-steel transom. Front and rear spring hangers are riveted to the side rails. There is a horizontal passage, from the front to the back, in the center of the forward transom. The drawbar tie is pivoted in this passage by the vertical pintle bolt.

e. The rear end of the drawbar tie is connected by steering rods and couplings to steering arms rigidly fixed to the steering knuckles. As the drawbar is a forward extension of the drawbar tie, the steering linkage causes the wheels to turn in unison to follow the movement of the drawbar when the drawbar is swung to either side.

### DESCRIPTION AND FUNCTIONING OF LIMBER

RA PD 37624

#### MODIFICATIONS

are of steel disk  
s, size 11.00-20,  
flation pressure,

9) are mounted  
eel studs in the  
and rim wheel

roller bearings  
le axle bearing  
d dowel washer  
e outer ends of  
enters.

#### Model M1918

M1917 and  
ushings. Each  
e interchangeable  
.918. Steering  
knuckles on  
re controlled  
limber.

the steering  
semi-elliptic,

proper rela-  
ng, which is  
h clamp the  
at each end,  
y the spring  
ng shackles.

s joined at  
som and at  
ng hangers  
n the front  
wbar tie is

ering rods  
uckles. As  
ng linkage  
the draw-

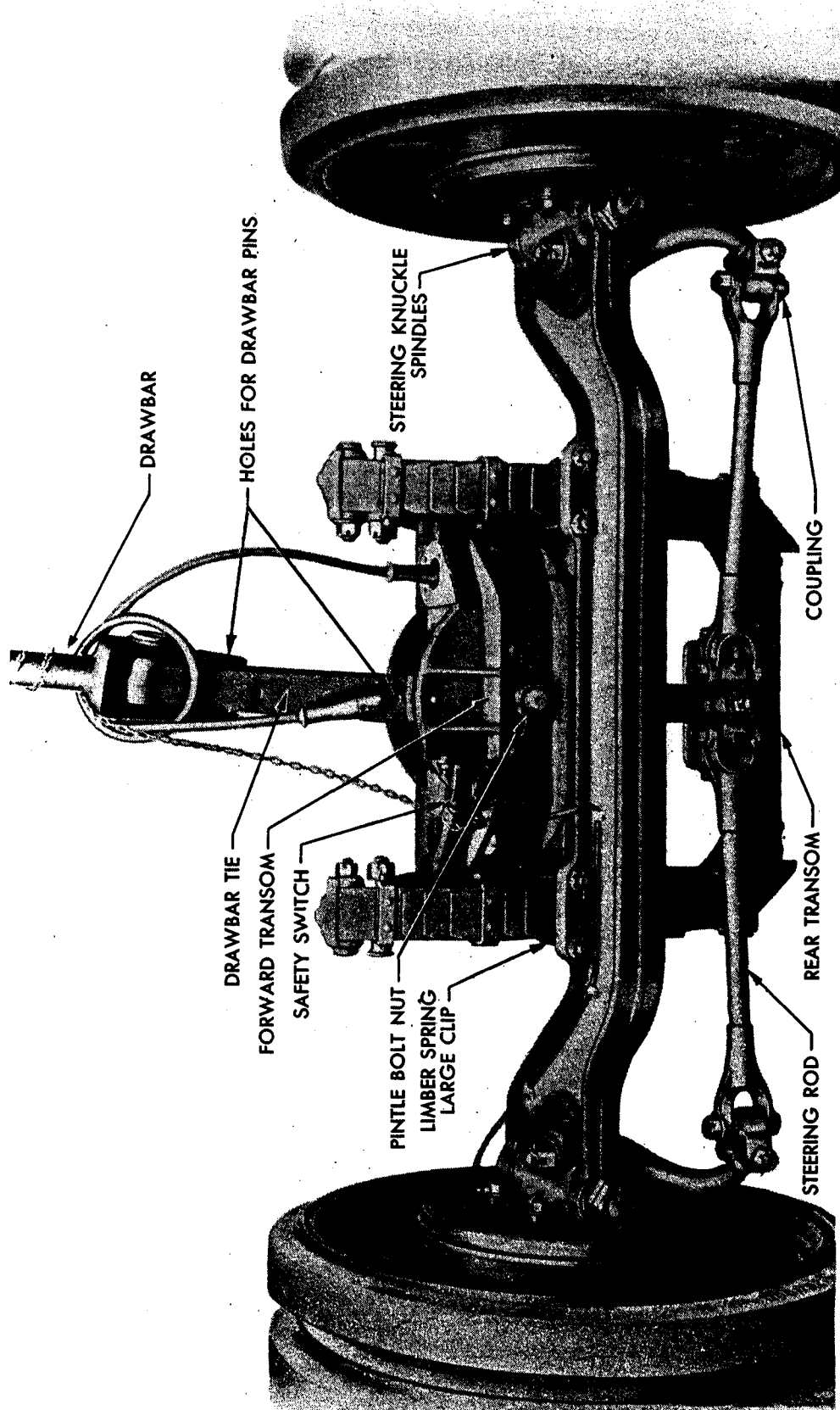

Figure 60—155-mm gun carriage limber, M1917A1

### 155-MM GUN MATERIEL, M1917, M1918 AND MODIFICATIONS

f. When the limber is drawn as a single vehicle, the wheels are locked at right angles to the axle by inserting a drawbar key through holes in the forward transom and the drawbar tie. It is also necessary to immobilize the hinge between the drawbar and the drawbar tie by inserting a second drawbar key through holes in the drawbar yoke and the drawbar.

### 35. 155-MM GUN CARRIAGE LIMBERS, M1917A1 AND M1918A1

a. The gun carriage limbers, M1917A1 and M1918A1 are the gun carriage limbers, M1917 and M1918, modified for high speed. The modification consists of the removal of the brake operator's seat, the installation of electric brakes and the equipping of the wheels with anti-friction roller bearings.

b. The electric brake mechanisms installed on the wheels of the gun carriage limbers, M1917A1 and M1918A1, are the same as those on the wheels of the gun carriages, M1917A1 and M1918A1, except that they have no provision for setting the brakes by hand. For a description of the electric brake system and its functioning, see paragraph 23.

### 36. TO ATTACH TRAILS TO LIMBER

a. When the trails, coupled together, are raised for limbering, the limber is backed under the trails until the rear beveled surfaces of the fifth-wheel trail rests (rear spring hangers, on limbers, M1917, M1918, M1917A1 and M1918A1) contact the limber stops attached to the under sides of the trails. The trails are then lowered until they rest upon the fifth-wheel trail rests (limber forward transom).

b. The trail clamping transom is laid across the trails behind the trail clamping transom stops, and drawn down and forward by the inclined trail clamping bolts, one on each side of the coupled trails. The result is a very rigid connection between the trails and the limber.

**MODIFICATIONS**

icle, the wheels are  
ar key through holes  
lso necessary to im-  
rbar tie by inserting  
ke and the drawbar.

**M17A1 AND**

M1918A1 are the  
or high speed. The  
perator's seat, the  
wheels with anti-

the wheels of the  
he same as those  
18A1, except that  
For a description  
aragraph 23.

or limbering, the  
l surfaces of the  
M1917, M1918,  
ed to the under  
y rest upon the

ails behind the  
orward by the  
pled trails. The  
he limber.

**Section V  
OPERATION**

	<b>Paragraph</b>
To place gun in battery.....	37
To check liquid in recoil system.....	38
To traverse.....	39
To elevate.....	40
To prepare for action.....	41
To load.....	42
To fire.....	43
To unload.....	44
To remove a fuze from a shell.....	45
To adjust counterbalance.....	46
To place in traveling position.....	47

**37. TO PLACE GUN IN BATTERY**

a. Maneuver the gun into position with the prime mover, with the muzzle pointing in the direction of fire.

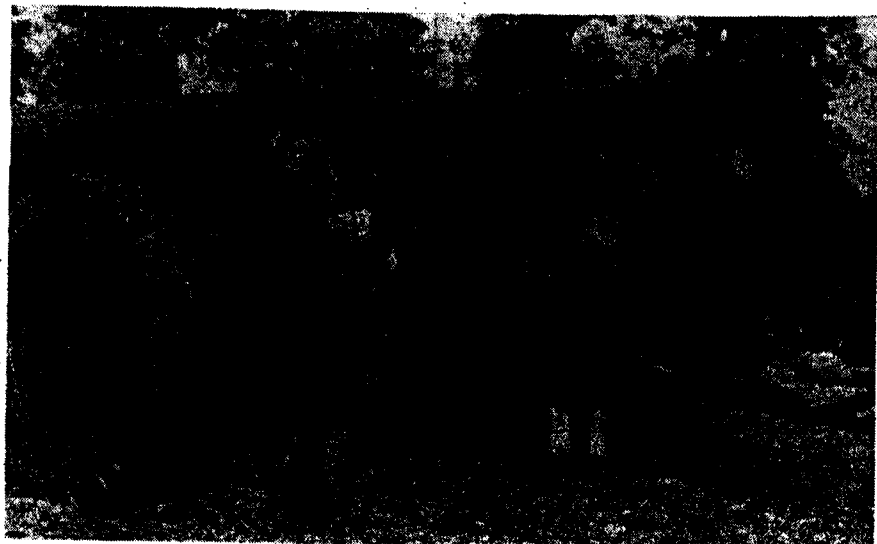

RA PD 37625

**Figure 61—Setting the hand brakes**

b. Set the hand brakes on the piece (fig. 61) to prevent movement of the carriage. If brakes are not securely set, the gun carriage may move when the jacks are being used to raise the trails.

c. Unload tools and accessory equipment and place them on a paulin. In bad weather, use half of the paulin to protect them, if another is not available for this purpose. Place blocks beneath the trails.

155-MM GUN MATERIEL, M1917, M1918 AND MODIFICATIONS

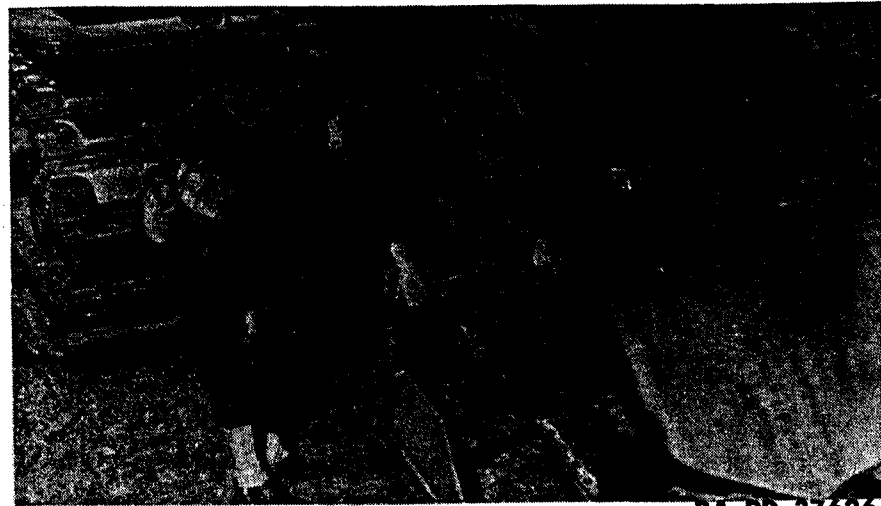

RA PD 37626

**Figure 62—Connecting the air line couplings to the dummy couplings**

d. Close the angle cocks and disconnect the air lines. Connect the air line couplings to the dummy couplings on the drawbar (fig. 62). This must be done to keep sand and dirt from the air lines. Sand and dust are destructive to the brake system.

e. Disconnect the lunette of the drawbar from the pintle of the prime mover. Lower the drawbar prop and pin it into position.

f. Remove the translating rack covers, breech, muzzle and piston rod covers. Remove the reflectors from the muzzle and breech of gun. Clean and lubricate the piston rod ends and nuts, translating racks, cradle, and gun slides.

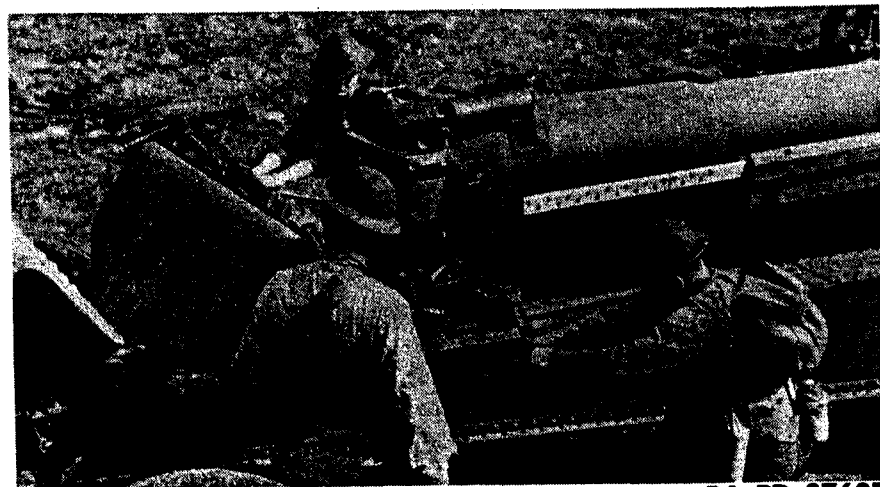

RA PD 37627

**Figure 63—Ratcheting the tube into battery**

g. (1) Attach the ratchet wrenches to the traveling lock pinion shafts, located at each end of the traveling lock beam, and unscrew the traveling bar clip screws, releasing the traveling lock beam.

**OPERATION**

(2) Ratchet the tube into battery (fig. 63). The person in charge will station himself where he can watch the progress of the traveling lock beam and control the movement of both pinions to keep the traveling lock beam square across the trails and avoid jamming and breaking of the teeth in the pinions and translating racks.

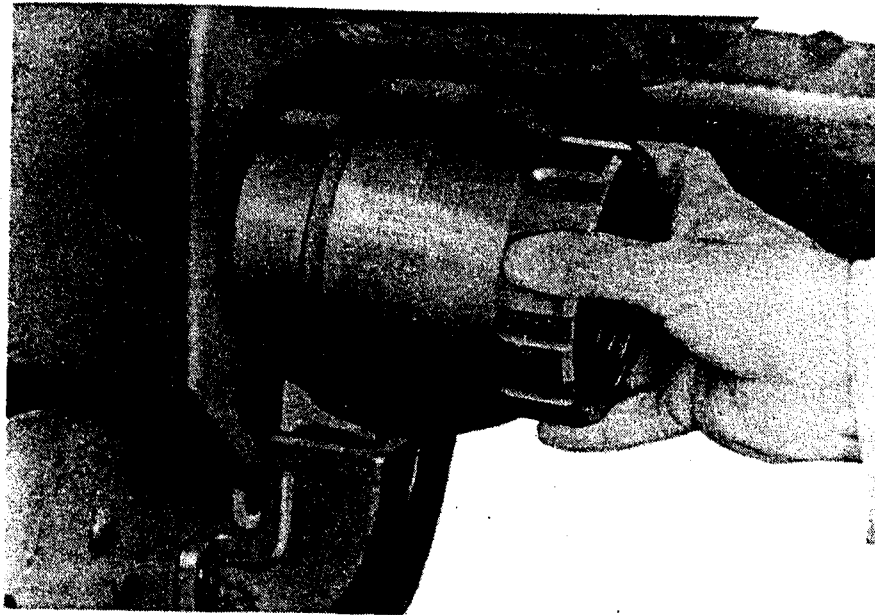

RA PD 23550

**Figure 64—Attaching the piston rod nuts**

h. Attach the recoil and counterrecoil piston rod nuts (fig. 64) to the recoil and counterrecoil piston rods, using the piston rod nut wrench.



RA PD 37628

**Figure 65—Remove the traveling lock**

i. Release the traveling lock locking screw until the traveling lock locking screw nut moves freely in the T-shaped slot in the lug at the bottom of the breech ring. Move the traveling lock beam to the rear to clear the gun and lift it off the trails (fig. 65).

**MODIFICATIONS**

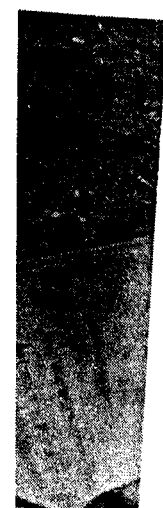

D 37626

by couplings

es. Connect the  
r (fig. 62). This  
Sand and dust

e pintle of the  
ition.

zle and piston  
breach of gun.  
slating racks,



7627

lock pinion  
nscrew the

155-MM GUN MATERIEL, M1917, M1918 AND MODIFICATIONS



RA PD 37629

*Figure 66—Placing the jack beam under the trails*

j. Place the jack beam across and under the trails (fig. 66). Insert the lug of the jack beam through the eye of the rear maneuvering lug on the bottom carriage and secure it in place with the key provided for this purpose.

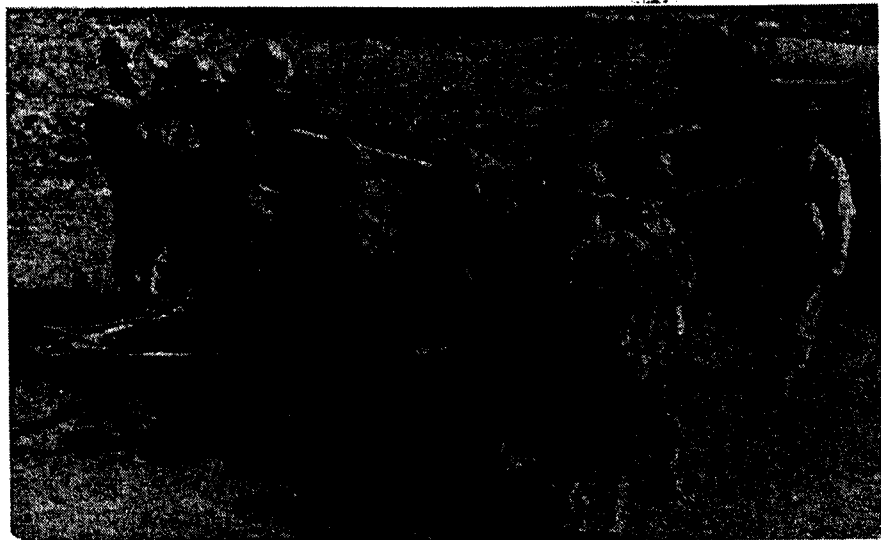

RA PD 37630

*Figure 67—Removing the spades from their traveling positions*

k. Loosen the spade retaining toggle turnbuckles and remove the spades and trail clamping transom from the trail. Remove the spades from the trails (fig. 67) and place them in the approximate locations they will occupy when fastened to the outspread trail ends. Unscrew the spade clamp bolt lock nuts for proper engagement. Spread the spade clamp bolts away from the center of the spade.



MODIFICATIONS

OPERATION

l. Disconnect the air line hose connections between the limber and the carriage and place them in the dummy air line hose couplings.

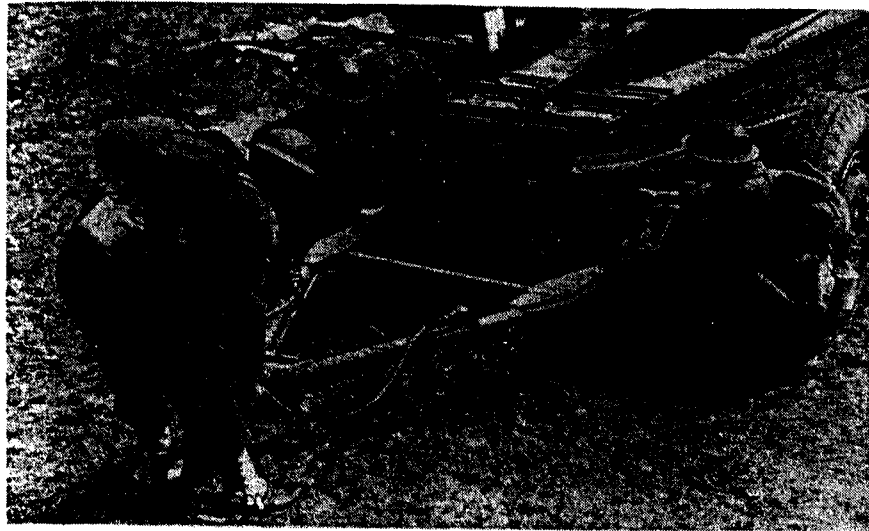

RA PD 37631

Figure 68—Engaging the drawbar lock pins

m. Release the prop and engage the drawbar lock pins (fig. 68) in the outriggers of the two drawbar yokes to hold the drawbar in position when the weight of the trails has been removed.

n. Engage the fifth-wheel locking pin in the fifth-wheel locking bracket. This is essential to maintain the alinement of the fifth-wheel trail rest ring assembly when the limber is detached from the trails.

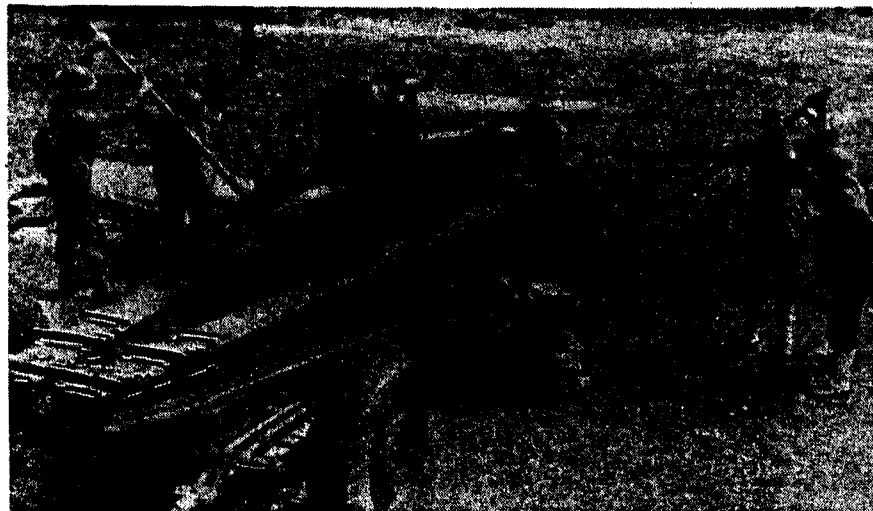

RA PD 37632

Figure 69—Placing the jacks beneath the jack beam

o. Loosen the trail clamping bolts and place the jacks beneath the jack beam (fig. 69). Blocking is required underneath the jacks to secure sufficient lift as well as to provide a solid foundation.

p. Raise the trails until the limber can be pulled from under the



PD 37629

rails  
s (fig. 66). Insert  
maneuvering lug  
key provided for



37630

positions  
id remove the  
ve the spades  
locations they  
Unscrew the  
ad the spade

## 155-MM GUN MATERIEL, M1917, M1918 AND MODIFICATIONS

trails. Move the limber by hand and couple it to the prime mover. The prime mover, limber and other transportation habitually will be removed from the position of the piece.

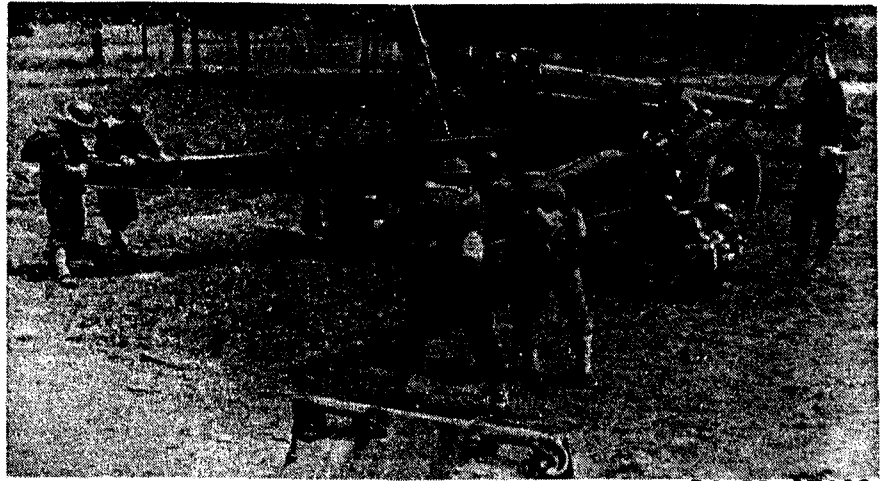

RA PD 37633

*Figure 70—Spreading the trails*

q. Remove the trail connecting pin and man the ends of the trails, spreading them slowly and evenly (fig. 70) until the trail locking bolts prevent further movement.

r. Jacks must be held firmly in place and blocking kept under the trails while they are in motion. Lock the trail locking bolts.



RA PD 37634

*Figure 71—Attaching the spades to the trails*

s. Attach the trail spades to the under sides of the trail ends, fastening the spade clamping bolts in the spade clamping transoms (fig. 71).

OPERATION



RA PD 37635

*Figure 72—Digging the spades into the ground*

t. Remove the blocking and lower the trails, digging in front of spade blades to permit them to sink into the ground (fig. 72). The weight of the trails on the spades will facilitate this work.

u. Remove the jacks, jack blocks and jack beam.

v. Mark the outline of the pit for gun clearance. The forward edge of this pit should be at the rear of the rear jack beam while its side edges should be one foot from the trails. The pit should extend to a line joining the outer ends of the two trails.

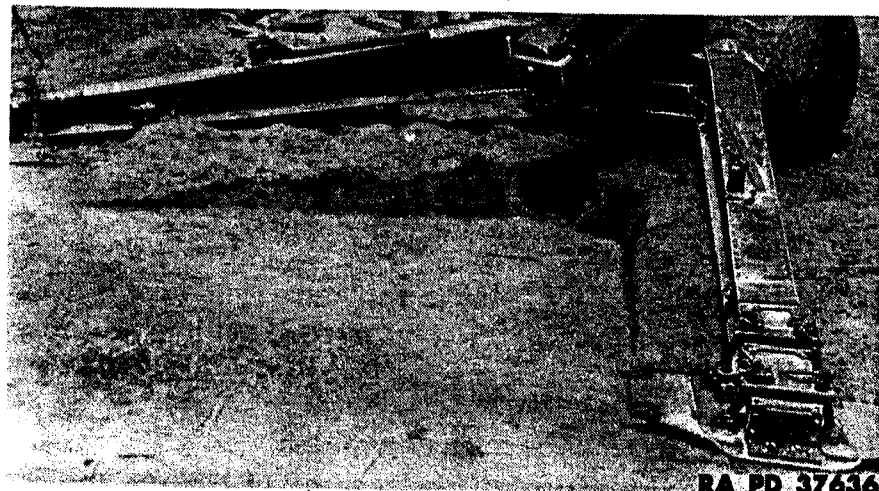

RA PD 37636

*Figure 73—The pit for gun clearance*

w. Dig the pit for gun clearance. The pit should be 30 inches deep

D MODIFICATIONS  
the prime mover. The  
ually will be removed



RA PD 37633

e ends of the trails,  
trail locking bolts

ng kept under the  
bolts.



PD 37634

ail ends, fasten-  
soms (fig. 71).

## 155-MM GUN MATERIEL, M1917, M1918 AND MODIFICATIONS

at the forward end under the jack beam and gradually tapered off to ground level near a line joining the outer ends of the two trails.

## 38. TO CHECK LIQUID IN THE RECOIL SYSTEM

a. Before firing, the recoil and counterrecoil mechanisms should be checked to determine if there is the proper amount of liquid in the replenisher and the counterrecoil system. They again should be checked after every tenth round. Insufficient liquid in the recoil system will result in damage to the mechanism.



RA PD 37637

*Figure 74—Gaging the oil in the replenisher*

b. Recoil. (1) The position of the replenisher piston indicates the amount of liquid in the replenisher cylinder. To measure the position of the replenisher piston, insert the 300-millimeter rule into the opening in the center of the rear face of the replenisher and push it until it comes in contact with the replenisher piston (fig. 74). Read on the rule the graduation which is flush with the rear face of the replenisher.

(2) The normal position of the replenisher piston is  $5\frac{15}{16}$  inches (150 mm). This position indicates a full recoil cylinder and sufficient reserve in the replenisher.

**NOTE:** When it is known that rapid fire is to take place, the replenisher should be drained until the reading of the replenisher piston is  $7\frac{7}{8}$  inches (200 mm).

(3) When the replenisher piston is at a point  $3\frac{15}{16}$  inches (100 mm)

**MODIFICATIONS**

ally tapered off to  
two trails.

**STEM**

hanisms should be  
of liquid in the  
ould be checked  
system will result



37637

on indicates  
the position  
the opening  
it until it  
on the rule  
isher.

5<sup>15</sup>/<sub>16</sub> inches  
d sufficient

place, the  
her piston

(100 mm)

**OPERATION**

or less from the rear face of the replenisher, oil should be removed from the recoil cylinder before firing is continued.

**NOTE:** When it is necessary, in an emergency, to continue firing without interruption, firing may be permitted until the reading is down to 50 mm (1.95 inches).

(4) When the replenisher piston shows a reading of 7<sup>7</sup>/<sub>8</sub> inches (200 mm) or more, oil should be added. To fill the replenisher, see paragraph 53 l.

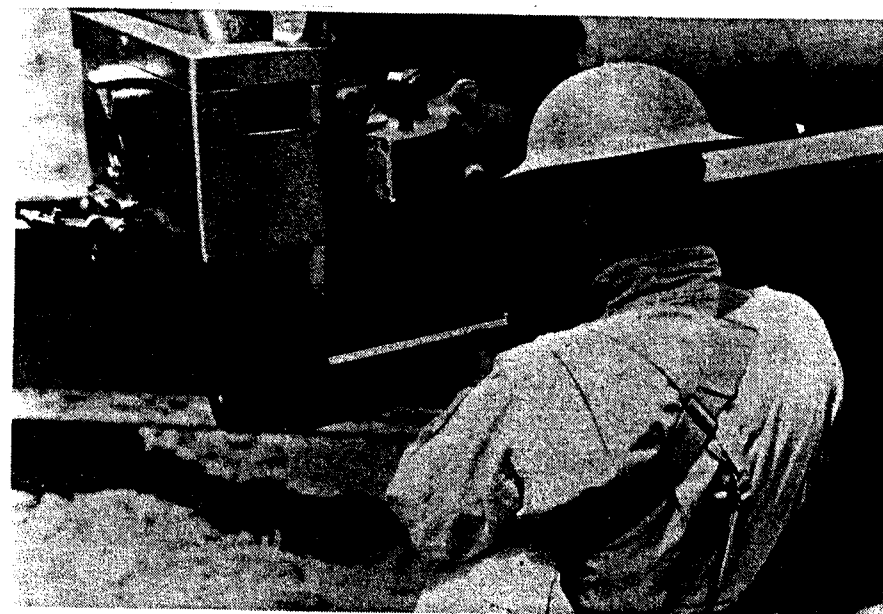

RA PD 37638

**Figure 75—Gaging the oil index of the counterrecoil system**

c. Counterrecoil. (1) The position of the oil index, which is directly below the recuperator filling valve, indicates the quantity of oil in the counterrecoil or recuperator cylinder. To measure the position of the oil index, hold one end of the 300-millimeter rule firmly against the cylinder head of the counterrecoil cylinder, with the edge of the rule parallel to and close to the oil index (fig. 75). Read on the rule the graduation opposite the end of the oil index.

(2) The normal position of the oil index is <sup>3</sup>/<sub>16</sub> inch (5 mm) out from the rear face of the cradle. To fill the recuperator cylinder see paragraph 53 o.

**39. TO TRAVERSE**

The traversing handwheel is located on the left side of the carriage at the rear of the sighting gear casing (fig. 76). One complete turn of the



RA PD 37639

**Figure 76—Traversing the gun**

handwheel traverses the carriage 43.2 minutes. Maximum traversing movement right and left is  $60^\circ$  ( $30^\circ$  either side of mid-position).

#### 40. TO ELEVATE



RA PD 37640

**Figure 77—Elevating the gun**

The elevating handwheel is located on the left side of the carriage at the left side of the sighting gear casing (fig. 77). One complete turn of the handwheel elevates the gun 28.72 minutes. The maximum range movement is  $0^\circ$  to  $35^\circ$ .

OPERATION

41. TO PREPARE FOR ACTION



RA PD 37641

*Figure 78—Attaching the panoramic telescope*

- a. Procure the telescope and place it in position on the quadrant sight (fig. 78) or mount. (The use of either the sighting platform, or of one or more blocks of wood, placed in the proper position, is optional.)
- b. Assemble lanyard, vent cleaning bit, oiler, waste, gunner's quadrant, primers, spare firing mechanisms, sponge on short end section of the staff, tub of water, rammer on the long end section of the staff, loading tray, fuze setter, fuze wrench, fuzes, powder and projectiles.
- c. Inspect the recoil and counterrecoil mechanisms to make certain they contain the proper amounts of liquid. Clean the replenisher piston guide and its two breather holes. Clean the 3-mm hole in the underside of the replenisher. Make certain that the gun slides are well lubricated and that the piston rod nuts are properly tightened.



RA PD 37643

*Figure 79—Removing the firing mechanism*

- d. Remove the firing mechanism (fig. 79), open the breech and examine the breechblock, primer vent, breech recess and gas check pad.

MODIFICATIONS



D 37639

um traversing  
sition).



540

ie carriage  
ete turn of  
um range

## 155-MM GUN MATERIEL, M1917, M1918 AND MODIFICATIONS

Clean and oil any part requiring it. Test the functioning of the counter-balance and make any necessary adjustment to facilitate opening and closing of the breech when large changes in elevation are to be made.

e. Examine, clean and oil the firing mechanisms. Two firing mechanisms are provided for each piece and they should be used alternately.

f. Examine the bore and the powder chamber. Swab the powder chamber with water.

### 42. TO LOAD

a. Release the percussion hammer by unlocking the percussion hammer lock bolt. Remove the firing mechanism and open the breech. Lock the percussion hammer lock bolt with the percussion hammer in the released position.

**CAUTION:** The percussion hammer lock bolt will not be unlocked until after the breech has been closed and locked and the piece is ready to be fired.



RA PD 37644

*Figure 80—Swabbing the powder chamber*

b. Swab the powder chamber and breech recess (fig. 80). If a charge has been fired, wipe off the powder residue from the obturator spindle, gas check pad, gas check seat, and the threaded sectors of the breech recess and breechblock with a cloth slightly dampened with light lubricating oil. Clean the primer vent with the vent cleaning bit. Inspect the bore for burning fragments of powder bags or other objects and for bore injuries.

c. Prepare the projectile. Verify the type, weight and lot number and examine carefully for defects. Remove the grommet and inspect the rotating band with special care and remove any burrs with a file. Clean the entire surface with a piece of waste or with a sponge and water. Sand



## OPERATION

or dirt on the projectile might cause premature detonation when the piece is fired.

d. (1) Fuze the projectile. Unscrew the eyebolt lifting plug from the fuze socket. Insert the designated fuze, being careful that it is fitted with its felt or rubber washer. Screw it home by hand. Give the fuze its final seating with the fuze wrench. No great force should be used. Set the fuze.

(2) If there is any difficulty in screwing the fuze home, the fuze should be removed and another inserted. If the same trouble is encountered with the second fuze, the shell should be rejected.

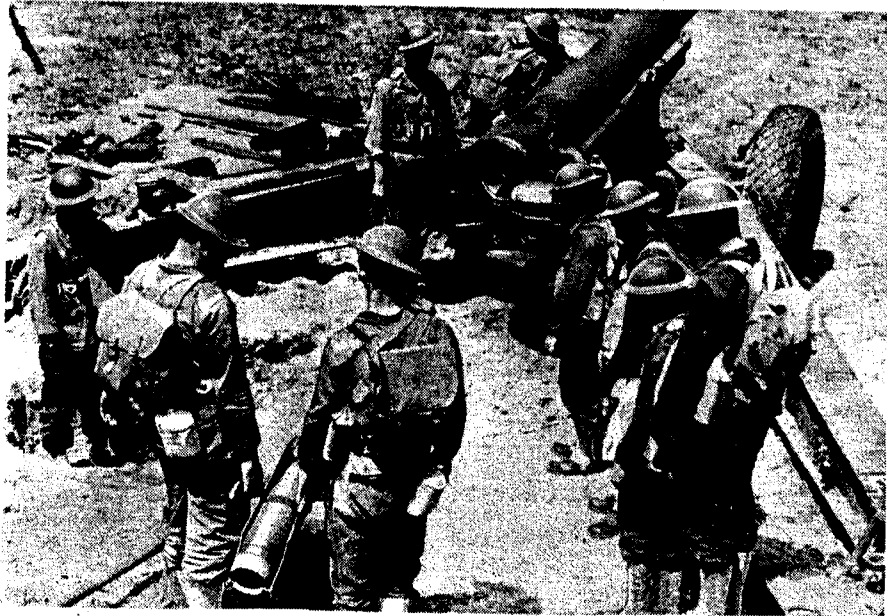

RA PD 37645

Figure 81—Bringing up the ammunition

e. Bring up the projectile on the loading tray (fig. 81). Place a prepared projectile on the loading tray. Grasp the handles of the tray and raise it with the front slightly above the rear. Get the proper grip as a shell may be dropped easily if the tray is not carried in the proper position.

**NOTE:** The projectile will not be brought to the rear of the recoil pit until after the gun has returned to battery.

f. Insert the lip on the bottom of the loading tray in the recess at the bottom of the breech recess. Lower the rear of the loading tray to bind the tray in place. Support the rear of the tray while the projectile is being rammed. Remove the loading tray after the projectile has been rammed.

g. Ram the projectile (fig. 82). Place the rammer head squarely against the base of the projectile, pushing it slowly until it has cleared

## MODIFICATIONS

ing of the counter-  
litate opening and  
are to be made.

isms. Two firing  
should be used

Swab the powder

the percussion  
open the breech.  
sion hammer in

not be unlocked  
e piece is ready



37644

ig. 80). If a  
he obturator  
ectors of the  
d with light  
bit. Inspect  
ects and for

lot number  
inspect the  
file. Clean  
water. Sand

## 155-MM GUN MATERIEL, M1917, M1918 AND MODIFICATIONS

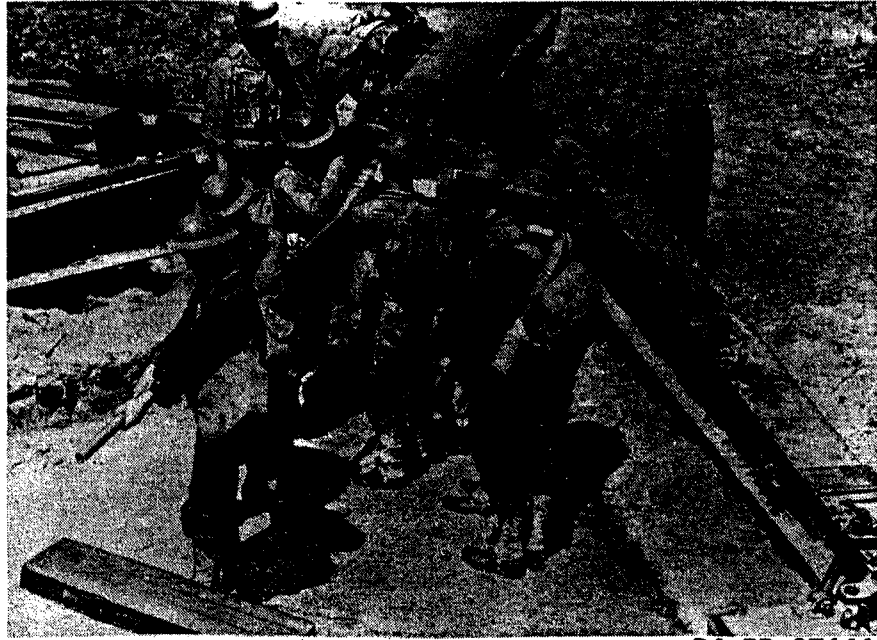

RA PD 37646

**Figure 82—Ramming the projectile**

the threads of the breech recess, then ramming it home with a powerful stroke. Uniformity of ramming is essential to accuracy of fire.

h. Prepare the powder charge. Open the powder containers. Remove the powder charges from the containers. Remove the protector cap from the igniter pad at the base of the charge. When "normal charge" is indicated, cut the tying straps and remove the increment section.

**NOTE:** For description of the propelling charge, see paragraph 116.



RA PD 37647

**Figure 83—Bringing up the powder charge**

## OPERATION

i. (1) Bring the prepared powder charge up to the breech immediately after the projectile has been rammed (fig. 83). An exposed powder charge will not be near the gun at any other time. Place the charge in the chamber, igniter end to the rear and lashed end to the front. Push it in until the base of the charge is flush with the rear end of the chamber.

(2) The charge is placed so that the igniter pad comes directly in front of the vent, to insure ignition of the charge. To insure transmission of the flash from the primer to the charge, the obturator spindle must come in contact with the base of the charge when the breech is closed, push the charge forward to its final position and remain in contact with it.

j. Insert a new primer in the firing mechanism and slide it into its proper seat. Should the primer be slightly oversize, or the primer seat dirty, the primer will stick before it is properly seated. Force should not be exerted. Remove the primer and clean the primer seat or insert another primer.



RA PD 37648

**Figure 84—Inserting the firing mechanism**

k. Insert the firing mechanism in the firing mechanism housing (fig. 84), taking care that the front end of the primer has entered the obturator spindle plug. Seat the mechanism by turning the firing mechanism handle in a clockwise direction until it has engaged the latch. If the mechanism will not seat properly, the primer may be oversize or its seat may be dirty, or the breech may not be fully closed.

**CAUTION:** Make certain that the firing mechanism is screwed home and latched in position. Despite safety devices, it is possible to fire the piece even though the mechanism is not completely in its proper firing position. If this occurs, damage to the breechblock and injury to the personnel may result.

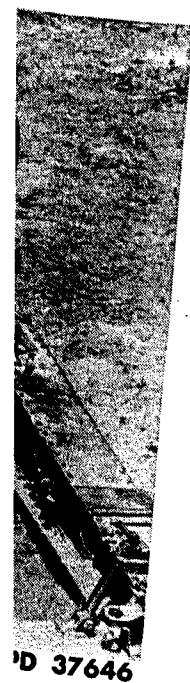

with a powerful  
fire.

containers. Re-  
the protector  
normal charge"  
t section.

paragraph 116.



## 155-MM GUN MATERIEL, M1917, M1918 AND MODIFICATIONS

### 43. TO FIRE

- a. Unlock the percussion hammer lock bolt and attach lanyard.

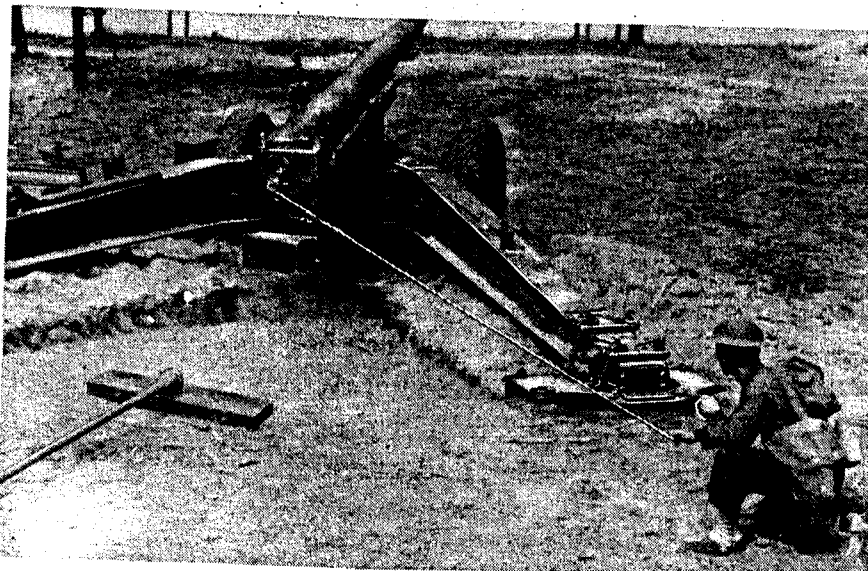

RA PD 37649

*Figure 85—Firing the gun*

- b. Grasp the handle of the lanyard with the right hand (fig. 85), and without raising the hand, pull strongly with a quick movement, prolonged sufficiently to insure the percussion hammer hitting the firing pin.
- c. Quickly release the lanyard handle.
- d. If the long lanyard is used, it is attached immediately before, and detached immediately after, the round is fired.

**NOTE:** In case of misfire follow instructions given in paragraph 70.

### 44. TO UNLOAD

a. **Service rounds.** No unloading rammer is provided with this materiel for use in unloading service rounds of ammunition. When it is desired to unload the piece, the projectile may be fired out of the gun after it has been determined that the field of fire is clear.

b. **Dummy projectile.** To unload the dummy projectile, lower the gun to a convenient elevation (about 150 mils) and with the loading tray in place, remove the projectile with the dummy projectile extractor. Place the hook of the extractor in the recess in the base of the dummy projectile and engage the hook on the shoulder. Then jerk the projectile to release the band stuck in the forcing cone. Push the projectile forward and repeat, if necessary. Use the extractor to guide the projectile on to the loading tray.

OPERATION

45. TO REMOVE A FUZE FROM A SHELL

If, for any reason, a projectile which has been fuzed is not to be fired, the fuze will be removed. The operation of inserting the fuze is reversed.

**CAUTION:** If the adapter starts to unscrew with the fuze, the unscrewing must be stopped at once and the shell disposed of as directed by the executive.

46. TO ADJUST COUNTERBALANCE

a. When large changes in elevation are made, it may be necessary to change the adjustment of the counterbalance to facilitate opening and closing of the breech.

b. To adjust the counterbalance, insert a pin through the hole in the lug at the end of the counterbalance regulating screw and turn the screw so as to move the counterbalance regulating nut farther from or nearer to the breechblock carrier hinge pin. It should be moved farther if the elevation is increased and nearer if the elevation is decreased.

c. To facilitate rapid adjustment, the position of the counterbalance regulating screw nut may be marked for various elevations.

47. TO PLACE IN TRAVELING POSITION

a. Bring the gun to a horizontal position in the center of the traverse.

b. Clean, thoroughly dry and cover with a thin coat of light oil, the bore, powder chamber, breech recess, breechblock and firing mechanism. Oil the top and bottom carriages. Lock the percussion hammer in traveling position.

c. Return the sights, firing tools and accessory equipment to their proper chests. Store the ammunition and close and store the powder containers.

d. Fill the recoil pit.

e. Unscrew the spade clamp bolt lock nuts sufficiently to permit the spade clamp bolts to be swung outwardly clear of the trails.

f. Place the jack beam and attach it to the maneuvering lug. Adjust the jacks under the ends of the beam.

g. Loosen the trail clamping bolts and raise the jack beam with the jacks until the ends of the trails are approximately one foot above the surface of the ground.

h. Swing the trails together, slowly and evenly, making certain

MODIFICATIONS

attach lanyard.



PD 37649

hand (fig. 85),  
lock movement,  
rotating the firing

immediately before,

paragraph 70.

ed with this  
. When it is  
of the gun

ctile, lower  
the loading  
e extractor.  
he dummy  
e projectile  
le forward  
ctile on to

## 155-MM GUN MATERIEL, M1917, M1918 AND MODIFICATIONS

that the trails are brought together on the exact center line of the carriage. Keep blocks under the trails for protection in case the jacks fall.

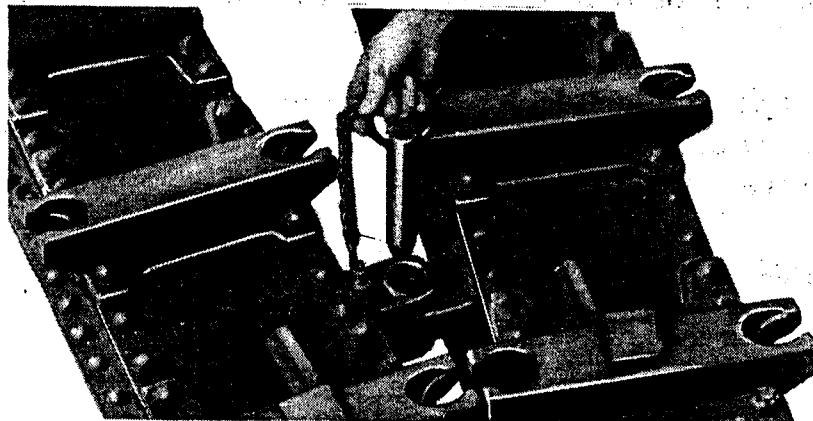

RA PD 37164

**Figure 86—Installing trail connecting pin**

- i. Fasten the trails together by inserting the trail connecting pin (fig. 86).

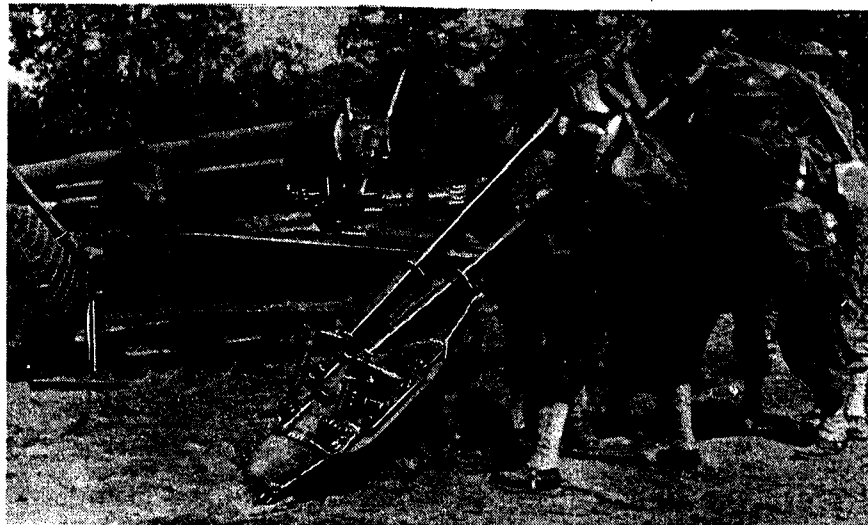

RA PD 37650

**Figure 87—Removing the spades from the ground**

- j. Pull the spades from the ground. Two lifting bars, inserted through the two maneuvering rings on one side of a spade, may be used to roll the spade from the ground with a little effort (fig. 87).
- k. Lower the trail and blocks for placement of the spades. Place the spades and trail clamping transom in position.
- l. Tighten the spade retaining toggle turnbuckles.
- m. Raise the trails sufficiently to clear the limber and back the limber under the trails. Care must be taken to insure that the pointed

OPERATION

ends of the fifth-wheel trail rests are accurately seated in the brackets of the limber stops on the under side of the trails.

n. Attach the trail clamping bolts to the trail clamping pins and screw down tightly to lock the trails to the limber.

o. Unlock the drawbar lock pins and fifth-wheel lock pin.

**CAUTION:** These lock pins must be disengaged before the loaded limber is towed or damage to the limber will result.

p. Make air line connections between the carriage and limber.

q. Remove the jack beam, jacks and jack blocks and load them on the proper transportation.

r. Remove the translating rack covers, unscrew the traveling bar clip screws and place the traveling lock across the trails underneath the breech ring. Procure the two ratchet wrenches.

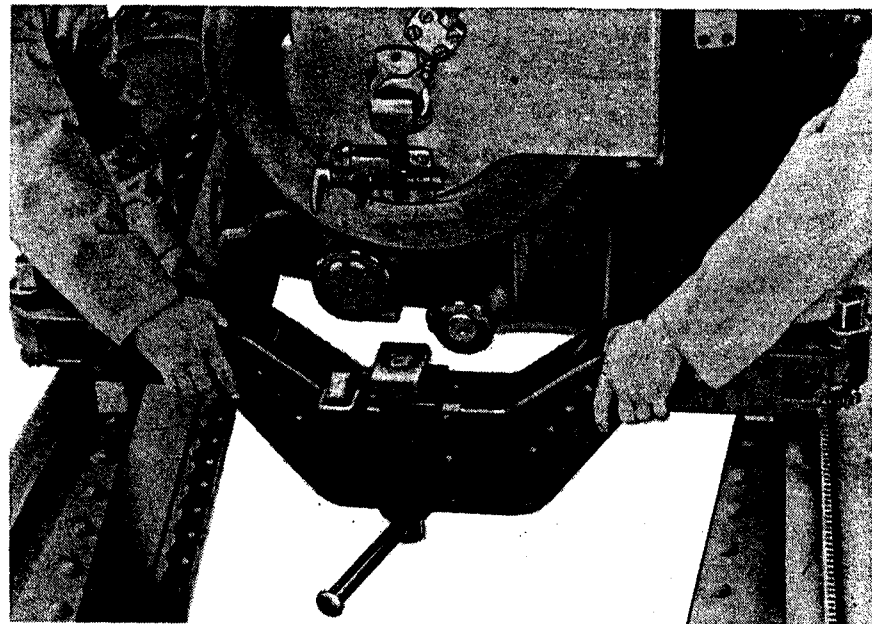

RA PD 23551

Figure 88—Installing the traveling lock

s. Insert the traveling lock locking screw nut in the T-slot on the underside of the recoil lug (fig. 88) and tighten until it is firmly attached.

t. Depress the breech until the pinions of the traveling lock mesh in the translating rack.

**CAUTION:** The traveling lock must clear the translating rack by at least 1/8-inch to protect the pinions and rack teeth from breakage.

u. Disengage the recoil and counterrecoil piston nuts. Replace the breech cover.

MODIFICATIONS

line of the car-  
the jacks fall.

7164

necting pin

nserted  
be used

Place

k the  
nted

### 155-MM GUN MATERIEL, M1917, M1918 AND MODIFICATIONS

v. Attach the ratchet wrenches to the traveling lock pinions and operate the wrenches simultaneously to rack the tube into traveling position and to properly seat the ends of the traveling lock under the traveling bar clip screws.

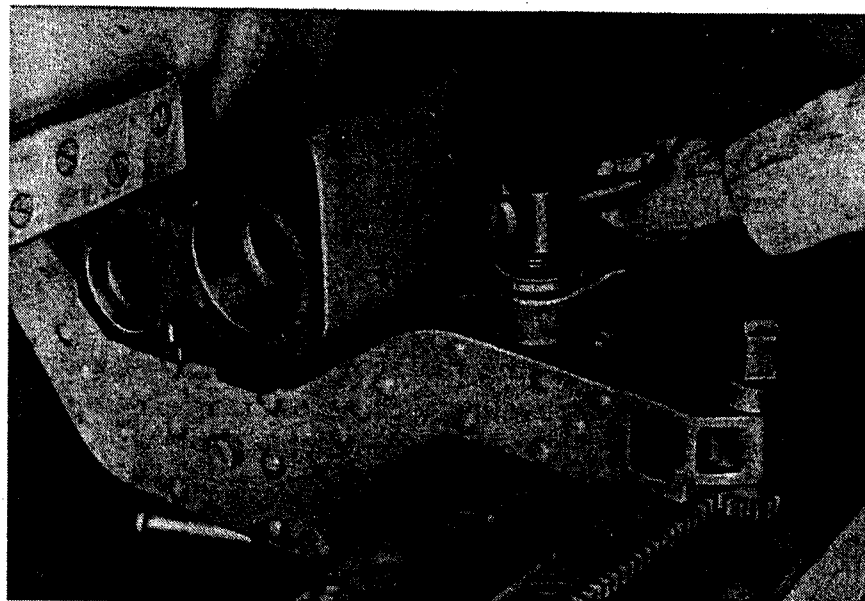

RA PD 37166

*Figure 89—Tightening the traveling bar clip screw*

- w. Screw down the traveling bar clip screws (fig. 89).
- x. Replace the traveling rack covers, breech, piston rod and muzzle covers and reflectors.
- y. Place the lunette of the limber over the hook of the pintle of the prime mover. Make the air line connections. Release the hand brakes on the carriage.
- z. Load all the remaining tools, accessory equipment, gun platform and blocks on the transportation provided for this purpose.



Section VI.

CARE AND PRESERVATION

	Paragraph
General.....	48
Organization spare parts and accessories.....	49
Lubrication instructions.....	50
Tube assembly.....	51
Breech mechanism.....	52
Recoil mechanism.....	53
Carriage and limber.....	54
Care of air brakes.....	55
Care of electric brakes.....	56
Care of manually-operated mechanical brakes.....	57
Cleaners and abrasives.....	58
Preservatives.....	59
Miscellaneous materials and tools.....	60

48. GENERAL

a. Proper care and preservation of the gun, carriage and limber are vitally important at all times, regardless of whether the gun is in action, traveling or inactive. A general inspection should be made periodically to determine if the weapon, as a whole, is receiving the necessary attention.

b. Dirt and grit, accumulated in traveling or from the blast of the piece in firing, settle on the bearing surfaces and, in combination with the lubricant itself, form a cutting compound. Powder fouling attracts moisture and hastens the formation of rust. Therefore, after traveling, at lulls during firing, and immediately after firing, the piece must be thoroughly cleaned. At other times, it should be cleaned at frequent intervals, depending upon the use and condition.

c. In disassembly, assembly or inspection, extreme care must be exercised to prevent any dust, dirt or other foreign matter from entering the mechanism of the gun.

d. Dirt on nonbearing surfaces usually can be removed by water. When cleaning the gun, water from a high pressure hose must not be directed against the trunnion bearings or trail pin housings, since this will result in water entering the bearings.

e. Oil-soaked dirt and grit, hardened grit and road oil can be removed with dry cleaning solvent applied by rags (not waste) or a brush.

f. When materiel is not in use, the proper covers must be used.

g. When the weapon is to be unused for a considerable time,

MODIFICATIONS  
lock pinions and  
to traveling posi-  
nder the traveling



7166

and muzzle  
the pintle of  
the hand  
n platform

## 155-MM GUN MATERIEL, M1917, M1918 AND MODIFICATIONS

the bore, breech mechanism and bright unpainted surfaces should be cleaned with dry cleaning solvent and the surfaces coated with medium rust preventive compound.

h. Should an enemy shell burst near the weapon, it must be determined that the weapon has not been damaged to a dangerous degree before the next round is fired. Damage of a serious nature should be reported to the ordnance officer.

### 49. ORGANIZATION SPARE PARTS AND ACCESSORIES

a. All organization spare parts should be kept in an orderly manner so that parts can be quickly located when required. They should be protected from loss or damage. Those parts susceptible to rust and corrosion must be thoroughly cleaned at regular intervals, and coated with a film of oil. Parts supplied in protective containers should be kept in the containers until required.

b. The sets of organization spare parts and accessories for the gun, the recoil mechanism, the gun carriage and the gun carriage limber should be maintained as completely as possible at all times. The sets should be checked with Standard Nomenclature List, D-11 and Standard Nomenclature List, D-30, and all parts used, and all missing parts and accessories should be replaced.

### 50. LUBRICATION INSTRUCTIONS

a. **General.** Satisfactory operation and long life of the materiel are not assured unless the materiel is kept clean and well lubricated. Apply sufficient lubricants but avoid wasteful practices. Excessive lubrication will result in dust accumulations on some moving parts and if not removed may cause wear and malfunctioning. Give particular attention to sliding and bearing surfaces, such as the gun slides and breech mechanism. Keep all exposed parts clean and well lubricated. The materiel should always be lubricated after washing.

(1) Lubrication charts (figs. 90 and 91) designate the oils and greases to be used and the lubrication intervals. Do not use any lubricants other than those prescribed. Fig. 91 is for the M2 and M3 models of carriage, but most points indicated apply also to other models.

(2) Identification of lubrication points. Lubricating fittings are painted red for ease in locating. Oil holes are encircled by a red ring.

(3) Cleanliness. Care must be taken when cleaning gear cases or sliding surfaces to insure the complete removal of all residue or sediment. Dirt or other foreign matter should not be allowed to drop into any of the lubricating compartments. Make sure all fittings and oil holes are clean before applying lubricant.

CARE AND PRESERVATION

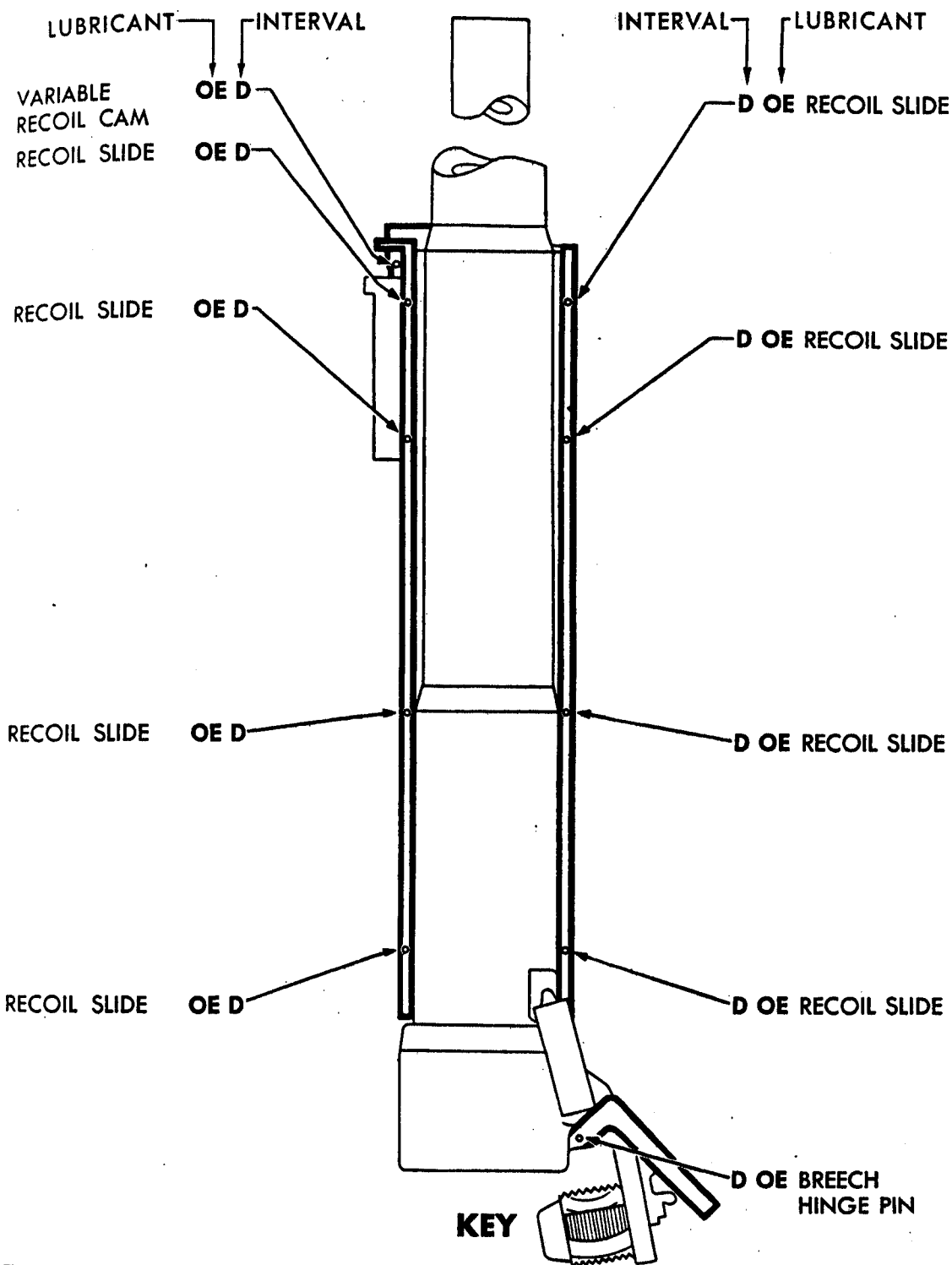

LUBRICANTS	
OE—Oil, Engine SAE 30 (above +32°) SAE 10 (below +32°)	MO—Oil, Lub. for Aircraft Inst. and M. G.

INTERVALS
D—DAILY

NOTE: See page 82 for lubrication of Carriage and Limber

RA PD 37710

Figure 90—Lubrication guide for 155-mm guns,  
M1917, M1917A1, and M1918M1

MODIFICATIONS

surfaces should be  
ated with medium  
l, it must be deter-  
dangerous degree  
nature should be

ESSORIES

n orderly manner  
y should be pro-  
st and corrosion  
ated with a film  
be kept in the

ries for the gun,  
carriage limber  
imes. The sets  
l and Standard  
sing parts and

f the materiel  
ll lubricated.  
cessive lubri-  
rts and if not  
lar attention  
ech mecha-  
he materiel

he oils and  
any lubri-  
M3 models  
dels.

ittings are  
d ring.

ar cases or  
sediment.  
to any of  
holes are

155-MM GUN MATERIEL, M1917, M1918 AND MODIFICATIONS

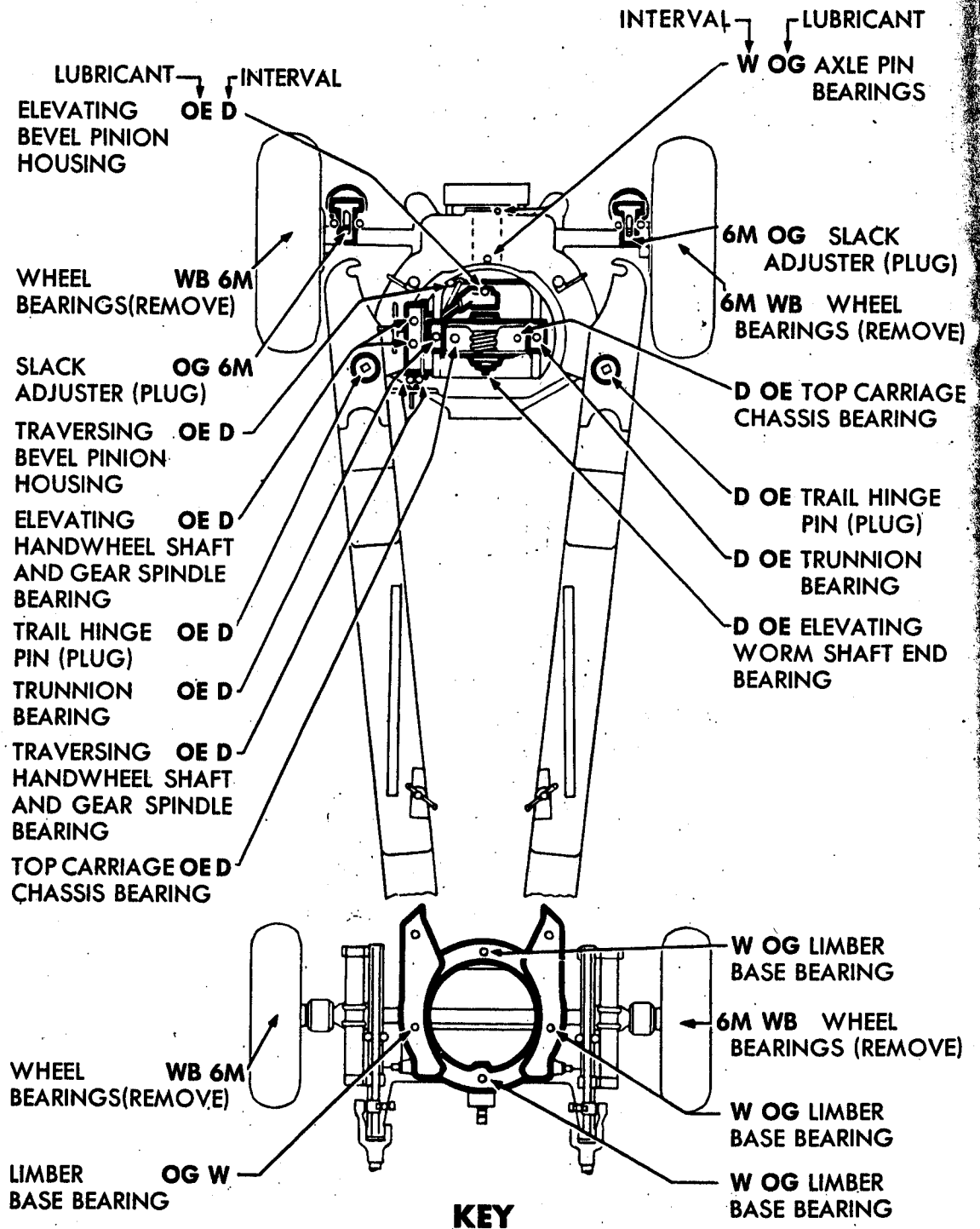

LUBRICANTS	
OE—OIL, Engine	OG—GREASE, O. D.
SAE 30 (above +32°)	No. 0 (above +32°)
SAE 10 (below +32°)	No. 00 (below +32°)
	WB—GREASE, General Purpose No. 2

INTERVALS
D—DAILY
W—WEEKLY
6M—6 MONTHS

NOTE: See page 81 for Lubrication of Gun and Cradle

RA PD 37709

Figure 91—Lubrication guide for 155-mm gun carriages, M2 and M3, and heavy carriage limber, M3

### CARE AND PRESERVATION

(4) Intervals. Lubrication intervals are given for normal service. For extreme conditions of speed, heat, water, mud, snow, rough roads, dust, and dampness, lubricate more frequently.

(5) Climate. Operation under special climatic and atmospheric conditions, such as extreme heat and humidity of the tropics or Arctic cold make necessary special treatment of the materiel. This special treatment may vary with the prevailing conditions, and the seasons, and is to be applied at the discretion of the ordnance officer. Before lubricating materiel for Arctic conditions, thoroughly remove all old lubricant. It is not necessary to clean out old lubricant when materiel prepared for Arctic conditions is to be lubricated for warmer climates. (See Section XVII, *Operation Under Unusual Conditions.*)

(6) Work the oil gun slowly and maneuver the parts oiled and greased to insure proper distribution of the lubricant.

(7) Should an oiler valve stick and prevent the passage of oil, loosen it with a piece of wire pushed through the hole. Care should be taken not to damage the valve.

(8) Records. Keep a complete record of lubrication servicing for the materiel.

b. Notes for lubricating the gun. (1) Recoil slides. Keep the exposed surfaces of the recoil slides coated with oil. Clean and oil them before firing.

(2) Breech and firing mechanism. Clean and oil all moving parts and exposed metal surfaces daily and before and after firing.

**CAUTION:** To avoid misfiring when the temperature is below freezing, remove the firing mechanism and dip it in dry cleaning solvent. Operate the firing pin in the solvent and then lubricate and replace the mechanism. Lubricate with oil, lubricating, for aircraft instruments and machine guns.

(3) Gun bore. Clean the bore of the gun and coat with oil after firing. Inspect daily and oil if necessary.

c. Notes for lubricating the recoil mechanism. (1) Clean and oil the valve-turning rod and connecting rods of the recoil and counterrecoil mechanisms while elevating and depressing the cradle.

(2) Clean and oil the ends of the recoil and counterrecoil piston rods and piston rod nuts with the gun in traveling position.

(3) Put a few drops of oil in the oil cup at the front end of the replenisher.

d. Notes for lubricating the carriage and limber. (1) To lubricate the wheels of the carriage and limber, remove the wheels and

### MODIFICATIONS

WAL → LUBRICANT  
WOG AXLE PIN BEARINGS

6M OG SLACK ADJUSTER (PLUG)

6M WB WHEEL BEARINGS (REMOVE)

D OE TOP CARRIAGE CHASSIS BEARING

D OE TRAIL HINGE PIN (PLUG)

D OE TRUNNION BEARING

OE ELEVATING FORM SHAFT END BEARING

NG LIMBER BEARING

B WHEEL BEARINGS (REMOVE)

LIMBER BEARING

LIMBER BEARING

INTERVALS
- DAILY
- WEEKLY
- 6 MONTHS

file  
PD 37709

13,

**155-MM GUN MATERIEL, M1917, M1918 AND MODIFICATIONS**

bearings, wash the bearings, inside of the hub and axle spindle, to remove all dust and old grease. When the bearings are dry, pack them with grease and reassemble. To pack a bearing, the grease should be kneaded into the space between the cage and inner race. Do not apply grease to the inside of the hub or on the spindle. (See par. 54 e or f; 89 b or c.)

(2) Elevating and traversing worms and sectors. The teeth of the elevating and traversing sectors and worms require little lubrication but, as a protection against rust, they must be covered with a thin film of oil. Clean and oil daily. Operate the mechanisms to their extreme positions to be certain of getting all parts cleaned and oiled. Clean and oil the traversing guide lug and the clip on the bottom carriage beneath which it moves. If considerable dust is present when the gun is operated, remove the oil. When the surfaces are dry there is less wear than when they are coated with grease contaminated with grit.

(3) Elevating bevel pinion housing. Fill the oil cups in the left end of the elevating bevel pinion housing to lubricate the bevel pinion teeth and bearings on either side of the elevating worm. The oil cups are accessible with the gun in firing position and the top carriage traversed to the left.

(4) Traversing bevel pinion housing. Fill the oil cup in the traversing bevel pinion housing. This is accessible when the gun is fully elevated and the oblique spindles are removed (par. 86 a). Also fill the oil cup in the rear stop of the elevating worm shaft.

(5) Fill the oil holes in the tops of the traversing spindle pinion arbor and elevating spindle bevel pinion. These are accessible when the gun is fully elevated and the oblique spindles are removed.

(6) Top carriage chassis bearing. Fill the open holes in the floor of the top carriage, on either side of the traversing worm. This lubricates the surface between the top and bottom carriage. The oil holes are accessible when the gun is elevated.

(7) Lubricate the traversing and elevating handwheel handles, trail locking bolts, trail clamping bolts, spade clamping bolts, drawbar guides, drawbar pin, ratchet rack and wrenches, and traveling lock pinions with oil, weekly.

e. Special instructions for gun carriages and limbers M1917, M1918, M1917A1 and M1918A1. (1) The foregoing lubrication instructions, wherever applicable, will be followed in lubricating the 155-mm gun carriages and limbers, M1917, M1918, M1917A1 and M1918A1.

(2) Differences in design, construction and operation of the gun axle, gun spring, wheel hubs, brakes, and limbers make certain changes necessary in lubrication procedure. In these cases, the following lubrication instructions will be followed.

CARE AND PRESERVATION

(3) The following parts will be lubricated daily, unless otherwise stated. Wherever oil is specified in these instructions, SAE 10 engine oil for temperatures below 32 F., and SAE 30 engine oil for temperatures above 32 F., should be used.

	Method	Amount	Remarks
Carriage axle and attachments:			
(See Notes 1 and 2)			
Connecting rod pins.....	Hand oiler	Film	Lubricate at contact surfaces.
Spring eye pins and shackles.....	Hand oiler	Film	Lubricate at contact surfaces.
Shackle adjusting bolt pins.....	Hand oiler	Film	Lubricate at contact surfaces.
Brake brackets (R and L)	Oil cups and hand oiler.	Fill oil cups	Also lubricate at contact surfaces.
Brake lever shaft and bearings.....	Oil cups	Fill	
Brake lever latch and handle.....	Hand oiler	Film	
Brake lever slots for quadrant.....	Hand oiler	Film	
Brake cable connections..	Hand oiler	Film	
Limber:			
Steering knuckle spindle..	Oil cups	Fill	
Spring eye pins.....	Hand oiler	Film	Lubricate at contact surfaces.
Steering tie rod universal joints (6).....	Oil cups	Fill	
Drawbar guides.....	Hand oiler	Film	
Drawbar pins.....	Hand oiler	Film	Lubricate on contact surfaces.
Pintle bolt.....	Oil cup	Fill	
Carriage and limber wheels:			
Bushing equipped.....	Hand pack	Pack hubs and bushings	Lubricate with grease, O.D., No. 0, at start of march and every 50 miles of travel.
Antifriction bearings.....	Hand pack	Pack bearings only	Lubricate with grease, wheel bearing, No. 2.

ODIFICATIONS

pindle, to remove  
pack them with  
ould be kneaded  
: apply grease to  
f; 89 b or c.)

The teeth of the  
lubrication but,  
thin film of oil.  
treme positions  
an and oil the  
beneath which  
n is operated,  
ear than when

in the left end  
l pinion teeth  
oil cups are  
age traversed

the travers-  
ally elevated  
e oil cup in

ndle pinion  
e when the

the floor of  
lubricates  
holes are

handles,  
drawbar  
ling lock

M1917,  
ation in-  
the 155-  
1918A1.

the gun  
changes  
lubrica-

## 155-MM GUN MATERIEL, M1917, M1918 AND MODIFICATIONS

NOTE 1. The great weight carried on the gun axle spring bushings forces out the lubricant; therefore, the spring eye pins should be withdrawn frequently, oiled, and reinserted. Oil the spring plungers in the forward ends of the spring eye pins and shackle adjusting bolt pins, at the same time working the plungers in and out to make sure of proper action. Work oil into the upper bearings of the lower spring shackle. The limber spring eye pins, especially the rear pins, should receive careful attention.

NOTE 2. The front and rear surfaces of the axle in the axle chamber, as well as the guides for the limber drawbar, should be covered with oil frequently while on the march.

## 51. TUBE ASSEMBLY

a. Cannon become less copper fouled when properly cared for, and it is known that the wear on cannon does not depend entirely upon the number of rounds fired, but very much upon the care given the bore in cleaning, oiling and cooling between rounds.

b. The accuracy life of cannon usually depends on the amount of erosion of the bore at the front of the forcing cone or beginning of the rifling. This condition is produced by a fast rate of fire and its attendant excessive overheating. Therefore, it is essential that after 10 minutes of firing, the piece be washed and oiled and allowed to cool. Each projectile will be cleaned before it is inserted into the bore of the gun. During firing, whenever the rate of fire permits, the bore should be swabbed with clean water and a sponge.

c. In cleaning after firing, wash the bore with a solution made by dissolving  $\frac{1}{2}$ -pound of soda ash, or one pound of sal soda, in one gallon of water, using the sponge for swabbing purposes. Wipe perfectly dry, using the sponge covered with burlap. Then oil the bore with a light coating of SAE 10 engine oil for temperatures below 32 F., and SAE 30 engine oil for temperatures above 32 F., applying it with the bore slush brush.

d. This procedure is to be repeated at the end of 24 hours, and again at the end of 48 hours. The purpose of the second and third washing, drying and oiling operations is to remove the effects of the chemical reactions of the burned powder which cannot be removed by the initial procedure.

e. The surfaces of the leveling plates should be protected from injury. In case of accidental injury, repair should be made by the personnel of the ordnance maintenance company.

f. When the gun is not actually in use, the muzzle cover should be in position.



CARE AND PRESERVATION

52. BREECH MECHANISM

a. The breech should be kept covered to prevent dust and grit from getting into the recesses of the mechanism and impeding its easy operation.

b. The breech mechanism should be kept clean and well lubricated. When in use, the breech mechanism should be disassembled, cleaned and oiled at intervals, and after each firing period. This is extremely important as no provision is made to oil by means of oiler or oil channels. It should be disassembled periodically when not in use and lubricated to prevent rusting.

**CAUTION:** In assembly or disassembly, do not use a steel hammer directly on any part. A copper drift or wood block should be interposed, or a copper hammer used to prevent deforming the part.

c. If the breechblock does not rotate smoothly, or if the mechanism requires a greater effort than usual to operate, this should be considered sufficient warning to warrant disassembly and determination of the cause.

d. It is important that any cutting or abrasion on the threads of the breechblock or in the breech recess be reported to the ordnance maintenance personnel for correction.

e. Extreme care must be taken to prevent injury to the gas check seat. Bruises in the gas check seat affect the seating of the split rings and are likely to cause leakage of gas and burning of the gas check pad. A leak may result in serious erosion. Because the gas check seat is susceptible to moisture, rusting of the gas check seat is likely to occur. The seat and rings, therefore, should be well protected by rust-preventive compound when the gun is not in use.

f. The firing mechanism parts require special attention and should be disassembled frequently for the purpose of cleaning and oiling. The parts should be washed with dry cleaning solvent to remove any gummy oil, after which they should be wiped dry and lubricated with SAE 10 engine oil for temperatures below 32 F., and SAE 30 engine oil for temperatures above 32 F.

g. Fouling of the firing pin or the use of heavier oil than specified may result in misfire. This is especially true in cold weather, as the oil may congeal and become gummy.

h. The primer seat and the vent hole in the obturator spindle should be kept clean by frequent use of the vent cleaning tool. The slightest accumulation of fouling in the primer seat will cause the primer to enter with difficulty and cause trouble in extraction.

## 155-MM GUN MATERIEL, M1917, M1918 AND MODIFICATIONS

## 53. RECOIL MECHANISM

a. The recoil and counterrecoil systems must contain the proper amount of reserve oil at all times or damage may result.

b. The recoil and counterrecoil mechanism should be examined regularly for leakage of oil. There is no cause for alarm should the oil drip rapidly, or even run in a stream, from the rear of the replenisher when the gun is elevated, provided the cradle has been at zero elevation for some time previously. This condition might exist on a normal replenisher. A leak at any packing that does not exceed three drops a minute is not considered serious; if loss of oil is greater, report to ordnance maintenance personnel.

c. Before firing, see that the gun slides are well lubricated, that piston rod nuts are properly tightened, and that a proper amount of reserve oil is in the replenisher and counterrecoil system. To check liquid in the recoil system, see paragraph 38.

d. During firing, the action of the recoil mechanism should be watched to see that the gun recoils with uniformly decreasing velocity and returns to battery smoothly and without shock, that there is no leakage of oil and that the recoil does not exceed the maximum permitted. (See subparagraph j of this paragraph). Excessive recoil will cause damage to the mechanism.

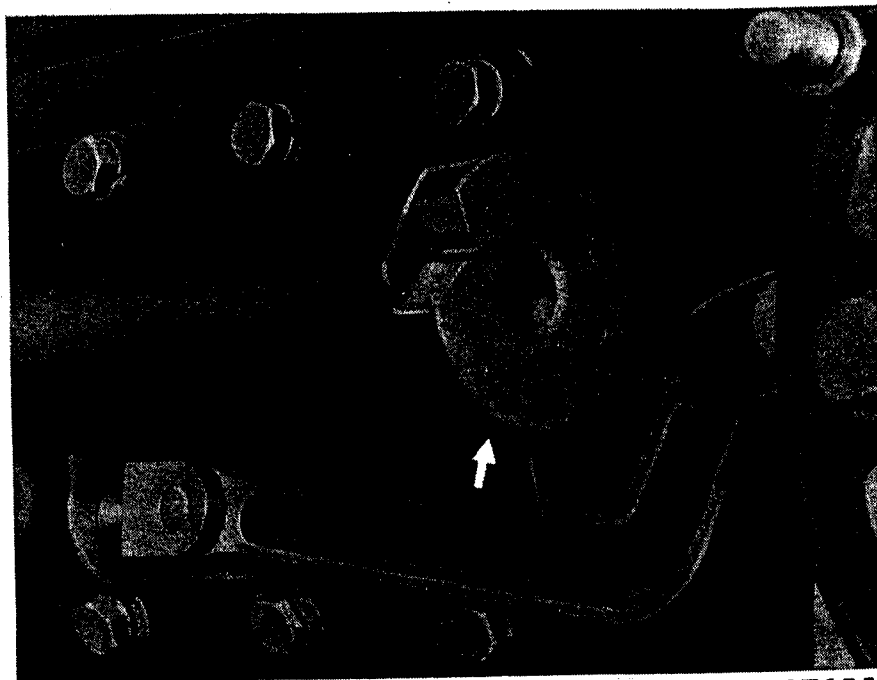

RA PD 37651

**Figure 92—The two air holes and the drain hole in the replenisher cylinder. Keep these holes open at all times.**

e. Keep open the air holes and drain hole in the replenisher cylinder (fig. 92). The two air holes are 2-mm continuations of the teat wrench

**CARE AND PRESERVATION**

holes in the replenisher piston guide and provide for circulation of air through the replenisher. The drain hole is a 3-mm hole in the underside of the replenisher, about 1 1/4 inches from the rear end. It is to drain the cylinder of accumulated water and oil that is passed by the replenisher piston.

f. Keep open the four small holes in the center of the counterrecoil front cylinder head (fig. 32). These are breather holes for the relief valve and it is very important that they be kept open. Use a wire for cleaning (wood may splinter and stop up the hole).

g. When replenishing the reserve oil, filter it through a piece of clean cloth, as well as through the wire strainer of the filling funnel. Every precaution must be taken to prevent the introduction of grit into the mechanism, either in the oil or through failure to clean thoroughly the filling pipe or connections.

h. Use a screwdriver to remove and replace a filling or drain plug. Be careful that the gasket beneath the plug is not lost. Examine the threads of the plug before replacing it. If the threads are in good condition, place and screw the plug upon the gasket, but do not force it excessively.

i. To measure the length of recoil. Coat the edge of the cradle with hard grease and adjust the recoil pointer until the point just touches the greased surface of the cradle. After the gun has fired and returned to battery, measure the distance between the point of the recoil pointer and the far end of its trace on the greased surface. (See fig. 29.)

j. Length of recoil. Under normal conditions, the length of recoil should be as follows:

Charge	Quadrant elevation in mills					
	100	200	300	400	500	600
Super inches	66 ± 2	66 ± 2	58 ± 2	45 ± 1	45 ± 1	45 ± 1
Normal inches	58 ± 2	58 ± 2	52 ± 2	43 ± 1	43 ± 1	43 ± 1

If the measured length of recoil does not fall within the tolerances given in this table, Section IX, paragraphs 72 p to 72 j, should be consulted and the proper corrective measures taken.

k. To test operation of replenisher piston. (1) Insert a scale through the opening of the replenisher piston guide and against the replenisher piston, then release oil from the recoil cylinder by means of the filling and drain valve release screwed into the recoil cylinder drain

**MODIFICATIONS**

contain the proper  
ult.

ould be examined  
arm should the oil  
of the replenisher  
at zero elevation  
on a normal re-  
ed three drops a  
er, report to ord-

lubricated, that  
oper amount of  
To check liquid

ism should be  
easing velocity  
at there is no  
um permitted.  
ill cause dam-



yl-  
cylin-  
rench

**155-MM GUN MATERIEL, M1917, M1918 AND MODIFICATIONS**

hole. If movement of the replenisher piston takes place, the replenisher piston is functioning.

(2) If the replenisher piston does not move, insert a block of hard-wood in the rear of the replenisher against the piston end, and tap with a hammer. When the replenisher has not been exercised, the piston rod may become rusted in the replenisher piston guide. Any rust on the piston rod should be removed as described in subparagraph n of this paragraph.

1. **To fill recoil system with oil pump, M3.** (1) Before filling the replenisher, test the operation of the replenisher piston, as described in the preceding paragraph.

(2) Unscrew the filling and drain plug from the recoil cylinder filling hole (on the left side of the replenisher), and screw the union of the pump coil loosely into the filling hole, and pump a little oil through until all air is excluded from the filling hole.

(3) Tighten the pump coil union without the use of a wrench, except for the final tightening. Extreme care must be taken to prevent injury to the threads of the filling hole, as any damage may put the entire cradle out of commission until repaired. With the filling and drain valve release in place in the recoil cylinder drain hole, work the pump and force oil through until it flows from the filling and drain valve release free from bubbles.

(4) Remove the filling and drain valve release, and continue to work the pump until the rear end of the replenisher piston is  $5\frac{15}{16}$  inches (150-mm) from the rear face of the replenisher. Remove the pump coil union, and replace the filling and drain plugs.

m. **To fill recoil system with oil screw filler.** (1) While the oil screw filler may be used to fill the recoil system, it requires careful handling to avoid breaking it off in the filling hole by the operator failing properly to balance the effort required to turn the handle. Only an experienced man should be allowed to use the oil screw filler, and it should be used only when no oil pump, M3, is available.

(2) Fill the oil screw filler with oil. To do this, unscrew the screw assembly of the filler as far as the threads permit. Unscrew the screw nut from the body, and remove the nut and screw. Hold the filler vertically, close the opening at the nozzle with a finger, and pour the filler three-quarters full of perfectly clean recoil oil. Replace the filler screw, and screw on the screw nut. Invert the filler and give the screw a turn or more to remove all air contained in the filler.

(3) Remove the filling plug from the replenisher. Screw the filler into the recoil cylinder filling hole of the replenisher (fig. 93). Use great

CARE AND PRESERVATION

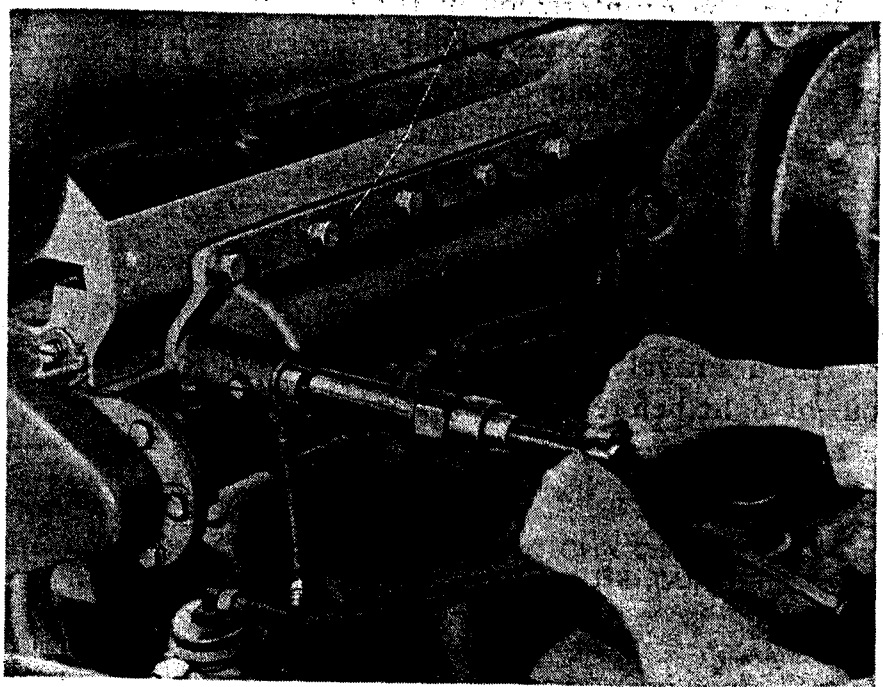

RA PD 37652

**Figure 93—Filling the recoil system with the oil screw filler when oil pump, M3, is not available. The oil screw filler can also be used to fill the counterrecoil system**

care to avoid damage to the threads. While still loose, give a few turns to the screw to force out any air which may be in the filling hole. Then tighten the filler's nozzle against the filling hole gasket.

(4) Turn the screw with both hands on the handle, balancing the effort so that there will be no tendency to push the filler to one side. Screw in the oil screw filler piston as far as it will go. Continue the above operation until the replenisher piston is  $5\frac{15}{16}$  inches (150-mm) from the rear face of the replenisher. Unscrew the oil screw filler and replace the filling plug.

n. To exercise replenisher piston. (1) The replenisher may be exercised by draining as much of the oil as possible (through the filling and drain valve release) and pumping in oil until the rear end of the piston rod projects to the rear of the replenisher. Any visible rust should be polished off the piston rod. Enough oil should then be withdrawn to bring the piston back to normal position.

(2) Guns not being fired should be exercised in the manner prescribed at least once a month.

o. To fill counterrecoil system with oil pump, M3. (1) The position of the oil index, which is directly below the filling and drain plug, governs all filling and draining of the system. The normal position of the oil index is  $\frac{3}{16}$  inch (5-mm) out from the rear face of the cradle.

### 155-MM GUN MATERIEL, M1917, M1918 AND MODIFICATIONS

(2) When the counterrecoil of the gun, or the position of the oil index, indicates that there is too small a quantity of oil in the recuperator, it will be necessary to drain off the reserve oil before refilling. This is accomplished by inserting the filling and drain valve release in the recuperator rear cylinder head. The reserve oil will spurt out in a stream and suddenly drop to a trickle. The amount of reserve oil which will escape will be approximately one quart.

(3) At this point, the flow of oil should be stopped by unscrewing the filling and drain valve release. It will be noted that the oil index has moved out of sight before all of the reserve oil has been released. If the oil index has not moved, tap it gently with a small piece of wood, as it may be frozen.

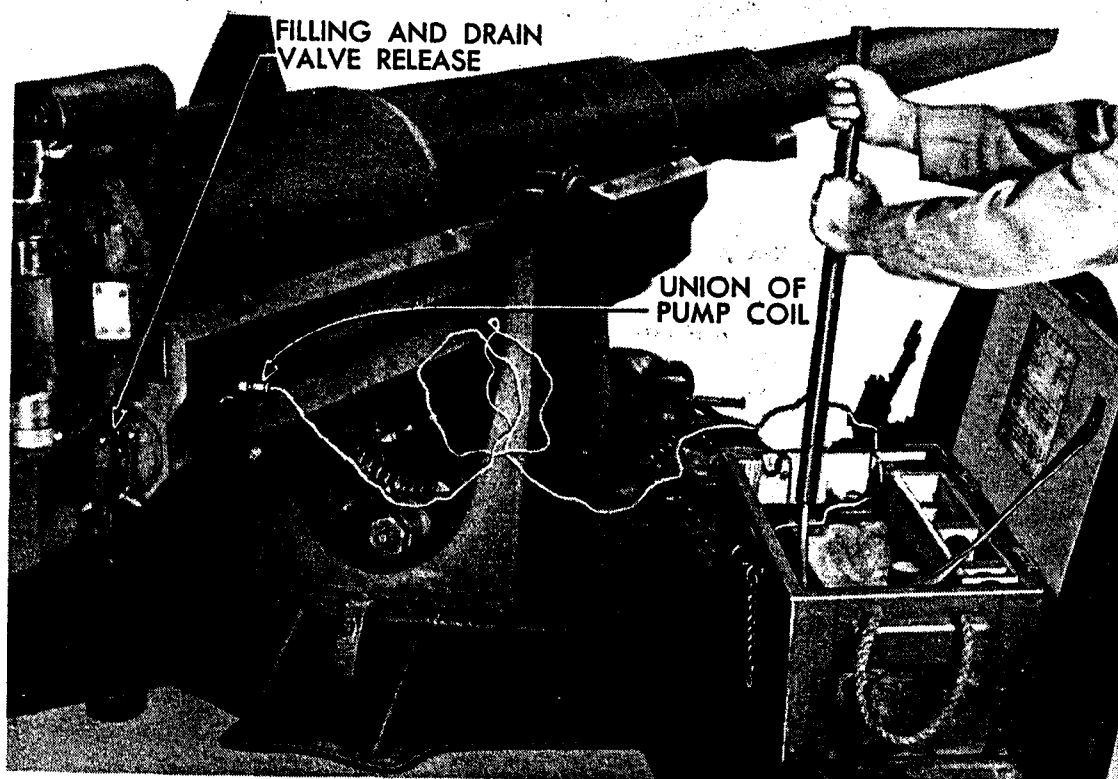

RA PD 37653

**Figure 94—Filling the counterrecoil system with the oil pump, M3. This is the prescribed method, and also should be used in adding oil to the recoil system**

(4) To fill the counterrecoil system, remove the plug from the filling hole located on the right side of the cradle. Clamp the pump chest to the right trail, purge the pump, clean the union and screw the union loosely into the filling hole (fig. 94). Work the pump a few strokes to clear the pipe and connection of air, and screw the union firmly against the gasket of the filling hole.

(5) Screw in the filling and drain valve release, and give the pump a few more strokes. Observe whether air bubbles appear in the escaping

**CARE AND PRESERVATION**

oil. If the oil is free from air bubbles, remove the filling and drain valve release. If not free, continue pumping oil through until they disappear. If air bubbles persist, this will indicate gas escaping by the floating piston. Report to the ordnance maintenance personnel.

(6) With the filling and drain valve release removed, give the pump 225 strokes, which will fill the cylinder with the required amount of oil. It will be noted that 67 full strokes of the pump will cause the oil index to move out to its maximum projection of  $\frac{3}{16}$  inch (5-mm) beyond the rear face of the cradle, but 158 more strokes on the lever are required to introduce the necessary reserve oil. Detach the pump and replace both plugs.

p. To fill recuperator with oil screw filler. Follow the same procedure in the release of the reserve oil as outlined for filling the system by means of the pump, subparagraph o (2) of this paragraph. Fill the oil screw filler with recoil oil, as outlined in subparagraph m (2) of this paragraph. Screw the oil screw filler into the filling hole located on the right side of the cradle. Force five to seven fillers full of oil into the recuperator cylinder after the oil index starts to move. Remove the oil screw filler and replace the filling plug.

**54. CARRIAGE AND LIMBER**

a. General. (1) Maintenance of the carriage and limber in service requires proper cleaning, strict observance of the lubrication program, tightening of loosened parts, and repair or replacement of broken parts. When traveling, it calls for the proper attention to the adjustments of the traveling lock, canvas and translating rack covers, trail clamping bolts, limber lock pins and wheel brakes, and to proper tire inflation.

(2) All bearing surfaces, screw threads and exterior parts must be clean and as free from dirt as possible. Special attention should be given exposed teeth and bearing surfaces. When disassembly and assembly operations are being carried on, the best available tools must be used and extra precaution must be taken to prevent the entrance of foreign matter into the working parts.

b. To adjust the elastic suspension. Remove the cotter pin, the retaining crown nut and the adjusting nut locking strap. Turn the spring suspension adjusting nut up (clockwise) or down (counterclockwise) to give a clearance of .012 inch between the elliptical bearing surfaces of the top carriage and the bottom carriage. Install the adjusting nut locking strap, retaining crown nut and cotter pin. (See figs. 95 and 96.)

c. Pneumatic tires and tubes. (1) To obtain maximum mileage, the tires should be checked frequently to see that they contain the

**MODIFICATIONS**

position of the oil in the recuperator, re refilling. This is release in the recuperator in a stream and which will escape

ed by unscrewing the oil index has released. If the ce of wood, as it

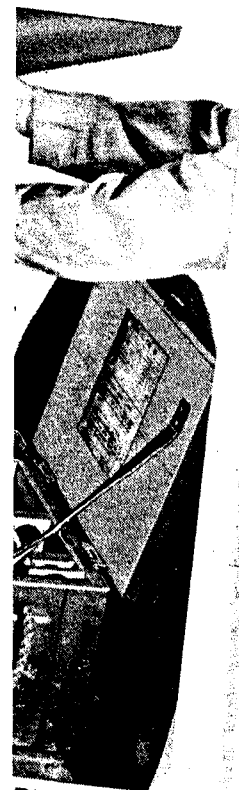

PD 37653

3. This to the

the filling st to the loosely lear the gasket

pump aping

54  
155-MM GUN MATERIEL, M1917, M1918 AND MODIFICATIONS

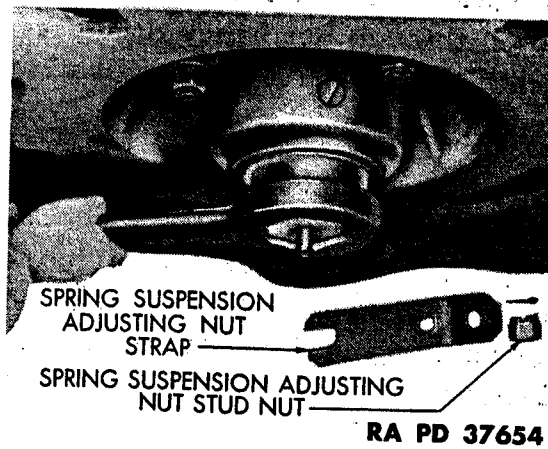

**Figure 95—Adjusting the clearance between top carriage and bottom carriage**

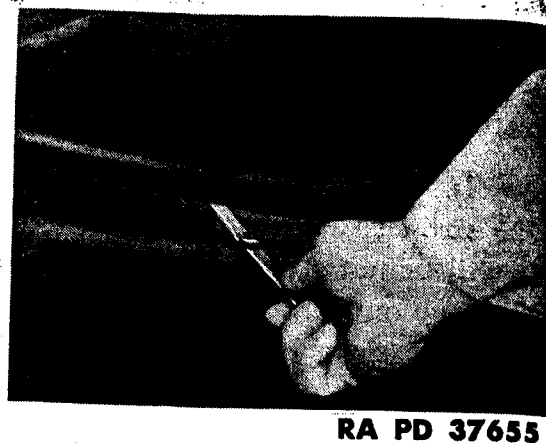

**Figure 96—Use a .012-inch feeler gage to determine the proper clearance on both sides**

proper air pressure. The correct pressure for limber tires is 70 pounds; for carriage tires, 90 pounds. It must be borne in mind that air expands when heated, and in hot weather, the tires must be checked for over-inflation as well as underinflation to avoid the possibility of blowouts.

(2) Remove all foreign substances from the rubber, being especially careful to keep tires as free from oil and grease as possible, as these have a deteriorating effect upon the rubber.

d. Solid tires. (1) Remove, by means of a screwdriver or small bar, any small stones or other foreign substance which may have become lodged in the rubber of the tires. If a strip of rubber is cut or torn on the edges of the tires, cut off the loose portion to prevent the strip from tearing further. Keep tires free from oil and grease, as these have a deteriorating effect upon the rubber.

(2) Caterpillar band segments should be kept clean and the segment pins well lubricated. Examine the fastening pins frequently and renew those showing evidence of wear or breakage before the segment pin is bent by coming partially out of its seat.

e. To adjust wheel bearings, carriages M2 and M3. (1) Jack up the axle so that the wheel and tire assembly is free to turn on the bearings. Remove the hub cap. Straighten out the bent portion (internal lug) of the axle end nut lock (washer) to release the axle end nut. Remove the axle end nut and the axle bearing adjusting nut.

(2) Remove or install sufficient shims to retain the bearings tightly, yet to permit the wheel and tire assembly to be rotated without binding (fig. 97). The proper adjustment is sometimes difficult to detect because of the weight of the wheel and tire assembly. The recommended



CARE AND PRESERVATION

MODIFICATIONS

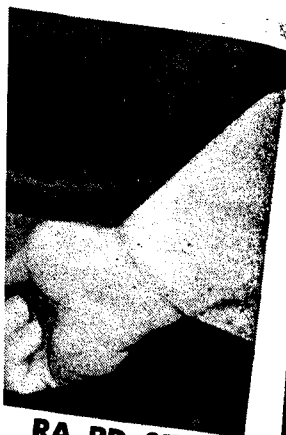

RA PD 37655

0.012-inch feeler  
proper clear-  
sides

is 70 pounds;  
at air expands  
ked for over-  
of blowouts.

ng especially  
is these have

ver or small  
ave become  
torn on the  
from tear-  
deteriorat-

l the seg-  
ntly and  
segment

13. (1)  
turn on  
portion  
le end

arings  
thout  
lect  
nded

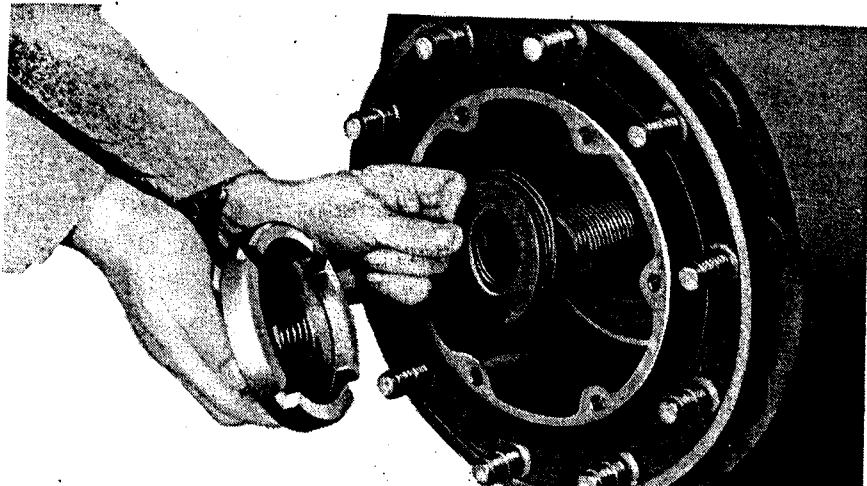

RA PD 37462

Figure 97—Placing bearing adjusting shims in position in adjusting the wheel bearings of the gun carriages, M2 and M3

procedure is to remove one shim at a time until binding occurs, and then to reinstall the last shim removed.

(3) When the bearing has been properly adjusted, install the axle end nut lock and the axle end nut. Bend the lug of axle end nut lock over the axle end nut to keep the latter tight. Install the hub cap, using a new gasket.

f. To adjust wheel bearings, limber, M3. (1) Jack up the axle so the wheel and tire assembly is free to turn on the bearings. Remove the hub cap. Remove the axle end nut and the nut and dowel washer. Turn the bearing adjusting nut and dowel clockwise until the bearings are tight, but the wheel and tire assembly can be rotated without binding. This is sometimes difficult to detect because of the weight of

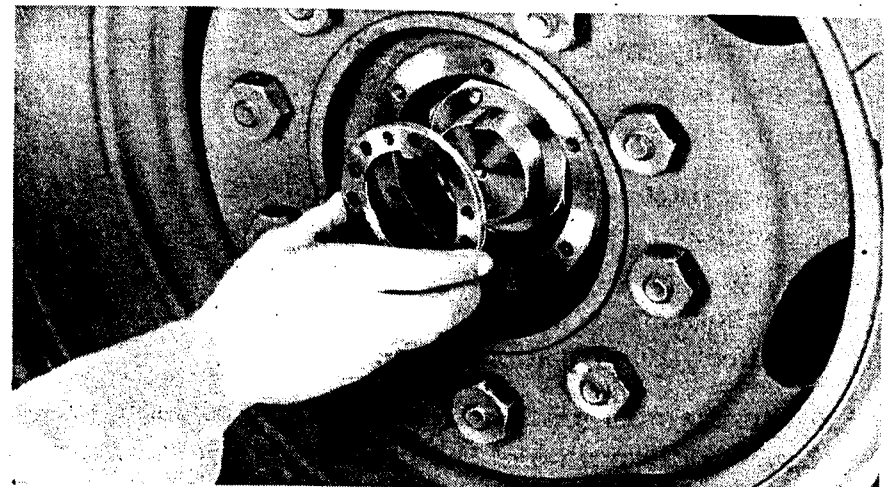

RA PD 37478

Figure 98—Placing the nut and dowel washer over the bearing adjusting nut and dowel to adjust limber wheel bearings

## 155-MM GUN MATERIEL, M1917, M1918 AND MODIFICATIONS

the wheel and tire assembly. The recommended method is to turn the bearing adjusting nut and dowel tight, and back it off about  $\frac{1}{6}$  turn.

(2) Install the nut and dowel washer (fig. 98), making certain that the dowel pin in the bearing adjusting nut and dowel enters a hole in the nut and dowel washer. It may be necessary to turn the nut and dowel washer over, or even to turn the bearing adjusting nut and dowel slightly in one direction or the other, to permit the dowel pin to enter one of the holes in the nut and dowel washer. The bearing adjustment should not be changed farther than the next hole.

(3) Install the axle end nut and tighten it securely. Then test the bearing adjustment, as the bearing adjusting nut and dowel may have been tightened when tightening the axle end nut. If so, remove the axle end nut and the nut and dowel washer, and repeat the bearing adjustment. Install the hub cap.

**CAUTION:** Do not attempt to loosen the bearing adjustment by merely loosening the axle end nut. This might permanently damage the bearings and axle hub.

g. To adjust wheel bearings—carriage and limber, M1917A1 and M1918A1. See paragraph 89 b, covering disassembly and assembly of wheels of carriage and limber, M1917A1 and M1918A1.

h. To adjust wheel bearings—carriage and limber, M1917 and M1918. See paragraph 89 c, covering disassembly and assembly of wheels of carriage and limber, M1917 and M1918.

## 55. CARE OF AIR BRAKES

a. General. (1) The complete air brake system should be inspected periodically for air leaks. [See par. 69 b (11)—(14).]

(2) It is vitally important that sand, dirt and other foreign matter be kept out of the air brake system. Couplings must be immediately fitted to dummy couplings after being uncoupled.

(3) The carriage air reservoir should be drained once a day to expel the accumulated moisture. This is done by removing the plug in the bottom of the reservoir. Replace the plug after all moisture has been removed. This moisture is taken into the system with the air, and if not expelled, will affect the operation of the system.

(4) Brake chamber push rod travel must be kept to a minimum to reduce the air consumption of the brakes. This calls for proper adjustment of brakes at all times. (See par. 55 b.)

(5) Do not move the gun with less than 65 pounds of air pressure in the reservoirs.

### CARE AND PRESERVATION

b. To adjust air brakes. (1) The two carriage wheel brakes are adjusted individually. Release the air brakes; release the hand brake of the brake to be adjusted; engage the other hand brake. Place a jack under the gun axle at a point just clearing the brake diaphragm bracket. Jack up the axle until the wheel and tire assembly is free to turn on the bearings.

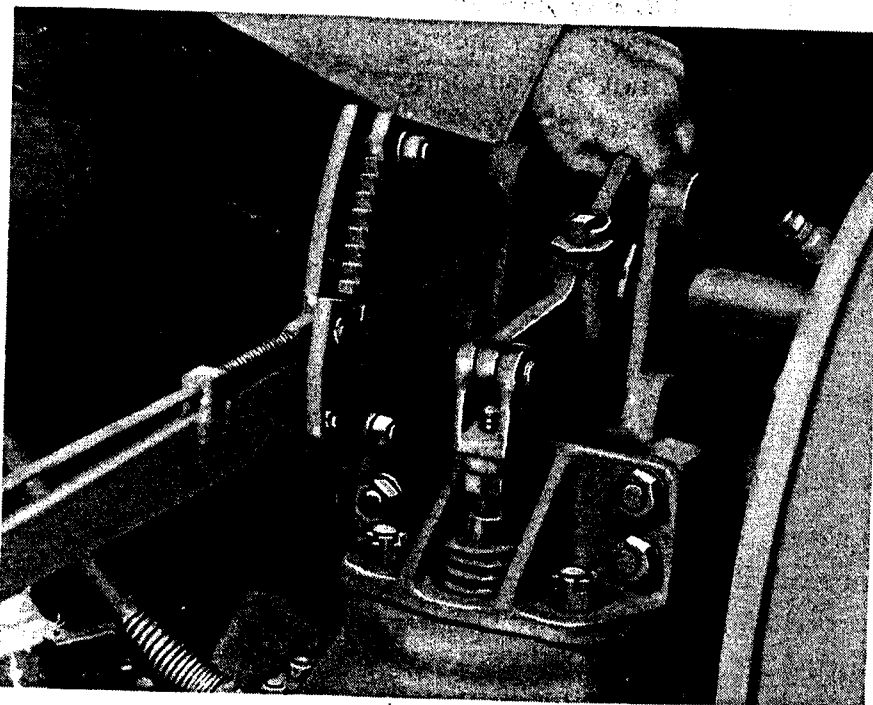

RA PD 37454

Figure 99—Adjusting the air brake mechanisms of the gun carriages, M2 and M3, by means of the brake slack adjusters

(2) With a 1/2-inch wrench, turn the square head of the shaft, which protrudes from the top of the brake slack adjuster, in a clockwise direction until the brake locks the wheel and tire assembly from rotating (fig. 99). Then, back off the adjustment by turning the shaft counterclockwise until the wheel and tire assembly turns freely. Adjust other brake.

c. To replace air line hose and hose connectors. Cut the air hose to the correct length, making sure that the ends are cut squarely. Assemble the spring and nut of the connector over the hose. Assemble the hose connector sleeve over the hose, with its outer edge 3/8-inch from the end of the hose. Force the end of the hose over the tube of the connector body. By joining the body and the nut of the hose connector, and drawing the threads up tightly, the castellated edges of the hose connector sleeve will be impressed into the hose to make a tight joint. Hose connector fittings should be screwed home firmly, but too much pressure will crush the hose connector sleeve and damage the fittings.

D MODIFICATIONS  
method is to turn the  
it off about 1/6 turn.  
making certain that  
wheel enters a hole in  
to turn the nut and  
locking nut and dowel  
dowel pin to enter  
bearing adjustment  
ely. Then test the  
dowel may have  
, remove the axle  
e bearing adjust-  
g adjustment by  
ntly damage the  
ber, M1917A1  
and assembly  
nber, M1917  
d assembly of  
ould be in-  
sign matter  
nmediately  
a day to  
e plug in  
has been  
nd if not  
inimum  
adjust-  
ressure

## 155-MM GUN MATERIEL, M1917, M1918 AND MODIFICATIONS

## 56. CARE OF ELECTRIC BRAKES

a. **Wiring and controller.** Check the wiring and the controller before examining the brakes. When the brakes are new, several applications must be made before maximum efficiency is obtained.

b. **Facing of magnet.** The facing of the magnet may become glazed. This is not characteristic of the facing, but is from some foreign substance imbedding itself into the material, resulting in a polished surface. If the facing cannot be roughened with coarse emery cloth, notify the ordnance maintenance personnel.

c. **Current.** (1) Check current at the brakes, using the ammeter furnished as an accessory. Disconnect one brake wire only. Connect one side of the ammeter to the brake; the other side to the terminal of the live wire that was removed from the brake. Leave the other brake in the circuit. Take a reading, which should not be less than 2.6 amperes. If this amount of current is not available, the brakes will not operate properly.

(2) Check for poor connections and partly broken or worn wires. Check current consumption of the brake on opposite side, with the other brake connected in the circuit. The reading of both magnets should not vary more than 0.1 of an ampere. In case there is a greater variation, check all connections for good contact or for a broken wire at the magnet. Test the battery of the prime mover to see if it is sufficiently charged to turn over the starting motor. When the test is completed, remove the ammeter from the circuit and connect the live wire to the brake terminal.

d. **Stop lights.** Stop lights must not be connected into the brake circuit. This changes the graduation of the current as it passes through the controller, resulting in weak or "grabbing" brakes.

e. **Bearings and wheels.** Worn bearings or loose wheels will cause erratic action of the brakes and will be evidenced by the wide track the pole faces of the magnets make on the armatures. The roller bearing must be adjusted by tightening the bearing adjusting nut, or replacing the bearing, if broken or badly worn.

f. **Brake lining.** Notify the ordnance maintenance personnel when brake lining is worn out, or has become greasy.

g. **Brake drums out of round.** Notify ordnance maintenance personnel.

h. **Brake band distorted.** Notify ordnance maintenance personnel.

i. **Broken or weak brake band spring.** Remove the wheel and replace spring.

CARE AND PRESERVATION

- j. Controller burned out. Replace with a new controller.
- k. Broken magnet spring. Remove the wheel and replace the spring.
  - l. Bushing in magnet worn out. Notify ordnance maintenance personnel.
  - m. Bent contactor blades in controller. Straighten blade with flat-nose pliers to correct spacing.
  - n. Broken spring in hand control. Replace with new spring.
  - o. Warped backing plate. Notify ordnance maintenance personnel.
  - p. Insufficient spacing between armature and magnet. Check with the armature gage. Notify ordnance maintenance personnel.

57. CARE OF MANUALLY-OPERATED MECHANICAL BRAKES

a. Lubrication. The brake cables should be lubricated with grease, O.D., No. 0, where they pass through the cable rocker bushings and rear cable guides on the trail. The ball connections should be oiled occasionally while stretched to maximum length, and exercised to work the lubricant into the spring chambers. Drops of oil should be placed at the joints of the links, and in the oil cups of the carriage brake brackets and limber shaft bearings. Oil the sides of the quadrant slot in the brake lever and the joints of the brake lever latch and handle.

b. To adjust mechanical brakes. (1) Raise both carriage wheels from the ground. Set the limber hand brake lever at two-thirds of its full travel on the brake quadrant. Have a man stand on one of the horizontal spokes of each wheel (the men should be of equal weight). Tighten the brake bands equally by screwing down the lower nuts of the brake band adjusting bolt until neither wheel revolves under the weight of the man on the spoke. Release the brake, and determine if both wheels are free to turn. Set the brake again, and repeat the test. The remaining one-third of brake quadrant travel will allow for wear. Set the upper nuts of the brake band adjusting bolts down hard against the lower nuts to secure them.

(2) All adjustments of the brake band for wear should be made through the brake band adjusting bolt, and not by taking up slack in the longitudinal or traverse cables. Stretching of the cables or slipping of the clamps may be remedied by readjusting and tightening the clamps.

c. To replace and adjust brake rocker spring. (1) Release the brake. Take off the brake shaft nut, unhook the ends of the spring,

IFICATIONS

l the controller  
several applica-  
l.

may become  
some foreign  
polished sur-  
cloth, notify

ing the am-  
e only. Con-  
the terminal  
other brake  
2.6 amperes.  
not operate.

worn wires.  
h the other  
should not  
variation,  
e magnet.  
charged to  
move the  
terminal.

into the  
it passes

eels will  
he wide  
e roller  
nut, or

rsonnel

enance

e per-

l and

## 155-MM GUN MATERIEL, M1917, M1918 AND MODIFICATIONS

and remove the brake rocker and spring. Clean and oil the clutch face. Put on the new spring and the brake rocker. Hook the ends of the spring, and screw on the brake shaft nut one or two turns. Draw the brake band tightly about the drum with any convenient clamp over the brake band ends.

(2) Set the limber brake lever at two-thirds of its full movement on the brake quadrant and draw the brake cable tight. The rear end of the brake cable will indicate the position of the upper end of the brake rocker. Tighten the brake shaft nut. The length of the brake cables should be such that the brake rocker is inclined about  $10^\circ$  forward of vertical.

## 58. CLEANERS AND ABRASIVES

See TM 9-850 and SNL K-1 for those prescribed, their application and use. The following are prescribed:

Burlap, jute, 8-oz., (40 inches wide)	Polish, metal, paste
Cloth, crocus	Remover, paint and varnish
Cloth, emery	Soap, saddle
Compound, cleaning, trisodium phosphate	Soda, ash
Compound, rust preventive, heavy	Soda, caustic (lye), for cleaning purposes
Compound, rust preventive, light	Solvent, dry cleaning
Lime, hydrated	Sponges
Paper, lens, tissue	Waste, cotton, (two grades, colored and white)
Paper, flint	

a. **Cloth, crocus.** Crocus cloth is used for removing rust and stains from threads of breechblocks and breech recesses, gas check seats, gas check rings, bearing surfaces of parts of breech mechanisms, and firing mechanisms. It may be used on steel shanks of sight mounts and steel seats of range quadrants. Its use on other sighting equipment is prohibited. Do not use any coarser abrasive on gas check seats. If crocus cloth is not sufficient to remove defects on surfaces specified above, notify the proper ordnance personnel.

b. **Cloth, emery.** This cloth is used for removing rust, burrs, and other defects from unfinished iron and steel surfaces, and for preparing them for painting. Its use on finished surfaces is forbidden.

c. **Compound, cleaning, trisodium phosphate.** This compound is used for cleaning the painted surfaces of the gun. Painted surfaces should be washed by cleaning only a small space at a time (approximately two square feet), rinsing this as soon as the surface is clean, and drying the surface immediately with a clean rag. Failure to

### CARE AND PRESERVATION

follow this procedure will result in stripping an excessive amount of paint from the surface.

d. Compound, rust-preventive. Heavy rust-preventive compound is used for the protection of materiel for long-time storage. The heavy compound should never be thinned by the light compound or by oil. Light rust-preventive compound is used primarily for short-time protection for finished surfaces of all kinds. It should not be used on materiel put in permanent storage, or for long-time protection.

e. Lime, hydrated. Hydrated lime is used, in a solution with lye, for the purpose of removing paint from metal parts. To prepare the solution for removing paint, dissolve one pound of soda, caustic, (lye) in six pints of hot water, and add enough lime to give the solution the consistency of paint. Use the solution freshly mixed, and apply with a swab of cotton rags or cotton waste tied to the end of a stick. When the solution begins to dry on the surface, use a scraper to remove the old paint. Apply two or three times, if necessary. After applying the lye solution, wash the materiel thoroughly with warm water to stop the action of the lye and lime. This solution does not attack rubber or steel but corrodes non-ferrous metal parts, and must be carefully handled because of the danger of getting in on the clothes, the skin, or in the eyes. It must not be used where it cannot be thoroughly washed off.

f. Paper, lens, tissue. This paper is used for cleaning lenses and other optical elements of sighting and fire control instruments, to remove dirt, lint, and moisture. In using this paper in the field, the optical surfaces may first be moistened by the breath, and the surface then cleaned with the paper. Avoid hard rubbing.

g. Paper, flint. This paper is used for preparing the surfaces of wooden elements, such as sponge and rammer staves, for varnishing.

h. Polish, metal, paste. Used for cleaning and polishing brass, bronze, nickel silver, aluminum, and other bright, unlacquered parts. This polish is used to supplement the work of crocus cloth.

i. Remover, paint and varnish. This is used to dissolve oil paint and varnish from wooden parts of materiel, or whenever it is impractical to use the lime-and-lye solution. Apply the remover very liberally with a three or four-inch varnish brush, using a single or one-way stroke only. Allow the remover to remain on until the old paint or varnish may be wiped or scraped off. Wash all the paint and varnish remover from the surface with dry cleaning solvent before applying new paint. Wash the brush with dry cleaning solvent and dry it before putting it into the fresh paint or varnish. Keep the paint remover out of any finished joint or bearing from which it cannot be thoroughly cleaned. It attacks rubber and should be kept away from insulated

**MODIFICATIONS**  
oil the clutch face.  
the ends of the spring,  
draw the brake band  
over the brake band  
its full movement  
it. The rear end of  
the rear end of the brake  
the brake cables  
at 10° forward of  
their application  
aste  
and varnish  
e), for  
ses  
ing  
vo grades,  
te)  
ing rust and  
check seats,  
mechanisms, and  
mounts and  
equipment is  
ts. If crocus  
ified above,  
rust, burs,  
id for pre-  
lden.  
This com-  
. Painted  
at a time  
surface is  
failure to

**155-MM GUN MATERIEL, M1917, M1918 AND MODIFICATIONS**

wires. As this mixture is inflammable, smoking is prohibited while it is being used, and as long thereafter as the fumes persist.

j. Soap, saddle. Used for cleaning leather equipment. Leather should be cleaned by carefully removing all hard grease with a sliver of wood (not glass or knife), and washed with a sponge saturated with a heavy lather of saddle soap and clean tepid water. Rinse thoroughly and rub vigorously with a dry cloth until the leather is dry. While the leather is still slightly moist, it should be given an exceedingly light coat of neat's-foot oil by rubbing with a soft cloth moistened (not saturated) with the oil. Leather equipment, which has become wet, should be dried in the shade. Wet leather, exposed to the sun or too high a heat from a stove or radiator, becomes hard and brittle.

k. Soda ash (sodium carbonate). Used in solution for cleaning bores and breech mechanisms and for removing grease and dirt from all types of ordnance materiel preparatory to painting, and whenever a general cleaning solution may be required. To prepare the solution, dissolve one-half to one pound (depending upon the strength desired) in one gallon of boiling water. In applying the soda ash solution to the bores of guns, see the instructions given in paragraph 51 c.

l. Soda, caustic (lye) (commercial), for cleaning purposes. Caustic soda is used with lime to remove paint. For the preparation of the solution, see subparagraph (e) of this paragraph.

m. Solvent, dry cleaning. This solvent is used for cleaning polished metal surfaces, preparatory to the application of rust-preventive compound. It is generally applied with rag swab. Remove excess by wiping with light colored cloth until no staining of the cloth occurs. This solvent is highly inflammable and smoking is prohibited in the vicinity of, or while handling the solvent.

n. Sponges. Either natural or synthetic cellulose sponges may be used, and in either case they should be used with very mild cleaning solution only. For the most part, they should be used with soap and water only. Solutions containing trisodium phosphate, soda ash, or lye, will ruin sponges of either type, and rags should be used with such solutions.

o. Waste, cotton, white. White waste is used for general cleaning purposes on finished surfaces of ordnance materiel where better grade than the colored cotton waste is required.

**59. PRESERVATIVES**

See TM 9-850 for information on rust, corrosion, inspection for corrosion, rust prevention, preparation of metal surfaces for slushing, method of slushing, inspection of grease films and storage conditions.



CARE AND PRESERVATION

a. Naphthalene, flake. (1) A flaked form of moth ball, used as a moth repellent to preserve the linings of helmets, felt wads, felt packings of instrument chests, carpet, gun sponges and paint and varnish brushes. It is sprinkled thickly on the articles which should, if possible, be then wrapped in paper covers and tightly boxed. The materiel should be thoroughly brushed and aired before packing and should be periodically inspected. If there are any signs of destruction by the moth larvae, the articles must be unpacked, cleaned and recharged with naphthalene.

(2) Naphthalene should be used in airtight receptacles in order to obtain a concentrated naphthalene vapor.

60. MISCELLANEOUS MATERIALS AND TOOLS

For the purpose for which used, see TM 9-850. They are:

Brushes

- Artist's, camel's hair, rd., No. 1.
- Flowing, skunk hair, No. 3 (2-in.)
- Sash-tool, oval, No. 1 ( $2\frac{5}{32}$ -in. x  $1\frac{3}{4}$ -in.)
- Sash-tool, oval, No. 3 ( $1\frac{3}{32}$ -in. x  $2\frac{1}{8}$ -in.)
- Scratch, painter's handled (14-in. x  $\frac{7}{8}$ -in.)
- Varnish, oval ( $1\frac{7}{8}$ -in.)

Chalk, white, railroad (1-in. x 4-in.)

Needle, sacking

Palm, sailmaker's

Twine, jute

a. Care of brushes. (1) Brushes are subject to attack by moths. Brushes in storage should be protected by naphthalene.

(2) Camel's hair brushes, after being thoroughly cleaned with turpentine, should be laid flat on a horizontal surface (not in water). For temporary storage, other paint brushes should be cleaned after using and kept with bristles submerged in fresh water, being careful that the bristles do not touch the bottom of the container.

Section VII

PAINTING

	Paragraph
General.....	61
Preparing for painting.....	62
Painting metal surfaces.....	63
Paint as a camouflage.....	64
Removing paint.....	65
Painting lubricating devices.....	66

61. GENERAL

a. Ordnance materiel is painted before issue to the using arms, and one maintenance coat per year will ordinarily be ample for protection. With but few exceptions, this materiel will be painted with enamel, synthetic, olive drab, lusterless. The enamel may be applied over old coats of long oil enamel and oil paint, previously issued by the Ordnance Department, if the old coat is in satisfactory condition for repainting.

b. Paints and enamels are usually issued ready for use and are applied by brush or spray after thoroughly shaking and mixing contents of can. They may be brushed on satisfactorily when used unthinned in the original package consistency, or when thinned no more than five per cent by volume with thinner. The enamel will spray satisfactorily when thinned with 15 per cent by volume of thinner. (Linseed oil must not be used as a thinner since it will impart a luster not desired in this enamel.) If sprayed, it dries hard enough for repainting within 1/2 hour, and dries hard in 16 hours.

c. Certain exceptions to the regulations concerning painting exist. Fire-control instruments, sighting equipment, and other items which require a crystalline finish, will not be painted with olive-drab enamel.

62. PREPARING FOR PAINTING

a. If the base coat on the materiel is in poor condition, it is more desirable to strip the old paint from the surface than to use sanding and touchup methods. After stripping, it will then be necessary to apply a primer coat.

b. Primer, ground, synthetic, should be used on wood as a base coat for synthetic enamel. It may be applied either by brushing or spraying. It will brush satisfactorily as received, or after the addition of not more than five per cent by volume of thinner. It will be dry enough to touch in 30 minutes, and hard enough in five to seven hours. For spraying, it may be thinned with not more than 15 per cent by volume

**PAINING**

of thinner. Lacquers must not be applied to the primer, ground, synthetic, within less than 48 hours.

c. Primer, synthetic, rust inhibiting, for bare metal, should be used on metal as a base coat. Its use and application are similar to that outlined in the preceding subparagraph.

d. The success of a job of painting depends partly on the selection of a suitable paint, but also largely upon the care used in preparing the surface prior to painting. All parts to be painted must be dry and should be free from rust, dirt, grease, kerosene, oil and alkali.

**63. PAINTING METAL SURFACES**

a. If metal parts are in need of cleaning, they should be washed in a liquid solution consisting of 1/2 pound of soda ash in eight quarts of warm water (or an equivalent solution), rinsed in clear water, and then wiped thoroughly dry. Wood parts in need of cleaning should be treated in the same manner, but the alkaline solution must not be left on for more than a few minutes, and the surfaces should be wiped dry as soon as they are washed clean.

b. When artillery or automotive equipment is in fair condition and only marred in spots, the bad places should be touched with enamel, synthetic, olive drab, lusterless, and permitted to dry. The whole surface will then be sandpapered with paper, flint, No. 1, and a finish coat of enamel, synthetic, olive drab, lusterless, applied and allowed to dry thoroughly before the materiel is used.

c. If the equipment is in bad condition, all parts should be thoroughly sanded with paper, flint, No. 2, or equivalent, given a coat of primer, ground, synthetic, and permitted to dry for at least 16 hours. They will then be sandpapered with paper, flint, No. 00, wiped free from dust and dirt, and a final coat of enamel, synthetic, olive drab, lusterless, applied and allowed to dry thoroughly before the materiel is used.

**64. PAINT AS A CAMOUFLAGE**

Camouflage is now a major consideration in painting artillery, with rust prevention secondary. The camouflage plan employed at present utilizes three factors: color, gloss and stenciling.

a. Color. Artillery is painted with enamel, synthetic, olive drab, lusterless, which was chosen to blend in reasonably well with the average landscape.

b. Gloss. The new lusterless enamel makes the materiel difficult to see from the air or from relatively great distances over land. Materiel painted with ordinary glossy paint can be detected more easily and at greater distances.

Paragraph

61

62

63

64

65

66

using arms,  
for protec-  
with enamel,  
d over old  
Ordnance  
epainting.

and are  
contents  
thinned  
ore than  
factorily  
oil must  
l in this  
1/2 hour,

g exist.  
which  
namel.

more  
iding  
pply

base  
; or  
tion  
ugh  
For  
me

## 155-MM GUN MATERIEL, M1917, M1918 AND MODIFICATIONS

c. **Stenciling.** White stencil numbers on materiel have been eliminated because they can be photographed from the air. A blue drab stencil enamel is now used which cannot be so photographed. It is illegible to the eye at distances exceeding 75 feet.

d. **Preserving camouflage.** (1) Continued friction or rubbing must be avoided, as it will smooth the surface and produce a gloss. The materiel should not be washed more than once a week. Care should be taken to see that the washing is done entirely with a sponge or a soft rag. The surface should never be rubbed or wiped, except while wet, or a gloss will develop.

(2) It is not desirable that materiel painted with lusterless enamel be kept as clean as materiel was kept when glossy paint was used. A small amount of dust increases the camouflage value. Grease spots should be removed with dry-cleaning solvent. Whatever portion of the spot cannot be so removed should be allowed to remain.

(3) Continued friction of wax-treated tarpaulins on the sides of materiel will also produce a gloss, which should be removed with solvent, dry cleaning.

(4) Tests indicate that repainting with olive drab paint will be necessary once yearly, with blue drab paint twice yearly.

## 65. REMOVING PAINT

a. After repeated paintings, the paint may become so thick as to crack and scale off in places, presenting an unsightly appearance. If such is the case, remove the old paint by use of a lime-and-lye solution (see par. 58 e for details) or remover, paint and varnish. It is important that every trace of lye or other paint remover be completely rinsed off and that the equipment be perfectly dry before repainting is attempted.

b. It is preferable that the use of lye solutions be limited to iron or steel parts. If used on wood, the lye solution must not be allowed to remain on the surface for more than a minute before being thoroughly rinsed off and the surface wiped dry with rags. Crevices or cracks in wood should be filled with putty and the wood sandpapered before refinishing. The surfaces thus prepared should be painted according to directions in paragraph 62 b

## 66. PAINTING LUBRICATING DEVICES

Oil cups, grease fittings, oil holes, and similar lubricating devices, as well as a circle about three-fourths of an inch in diameter at each point of lubrication, will be painted with enamel, red, water resisting, in order that they may be readily located.

Section VIII  
INSPECTION AND ADJUSTMENT

	Paragraph
Visual inspection on receipt.....	67
Serial numbers.....	68
Inspection.....	69

67. VISUAL INSPECTION ON RECEIPT

a. Upon receipt of the 155-mm gun, carriage and limber, it is the responsibility of the officer in charge to ascertain whether the materiel is complete and in sound operating condition. A record should be made of any missing parts and any malfunctions, and the condition should be corrected as quickly as possible.

b. Attention should be given to small and minor parts as these are the more likely to be lost, and they may seriously affect the proper functioning of the materiel.

c. This visual inspection on receipt should be followed as quickly as possible by a complete inspection which will fully disclose the functioning of the materiel. (See paragraph 69 of this section.)

68. SERIAL NUMBERS

a. Four serial numbers are required for records concerning the components of this materiel. They are the gun serial number, the recoil mechanism serial number, the carriage serial number and the limber serial number. These numbers are located as follows:

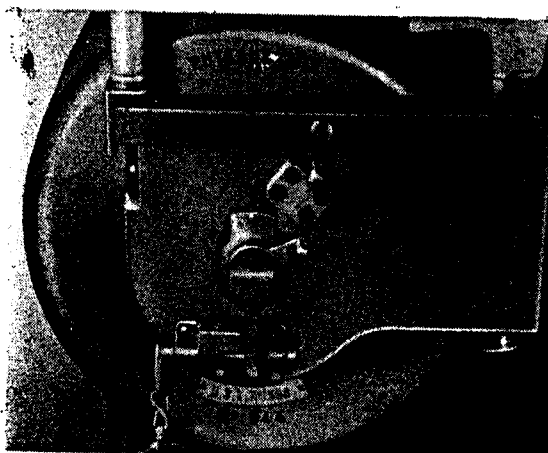

RA PD 37406

Figure 100—Gun serial number

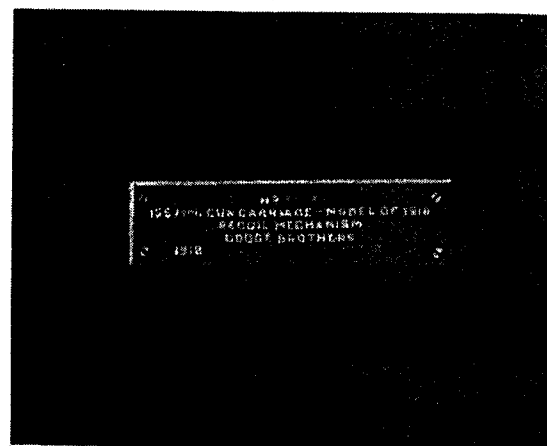

RA PD 37703

Figure 101—Recoil mechanism serial number

b. Gun serial number. On brass plate on the rear face of the breech ring directly below the breechblock carrier. This is the official serial number of the gun (fig. 100)

155-MM GUN MATERIEL, M1917, M1918 AND MODIFICATIONS

c. Recoil mechanism serial number. On a metal plate on the left outside upper face of the cradle, forward of the trunnion (fig. 101).

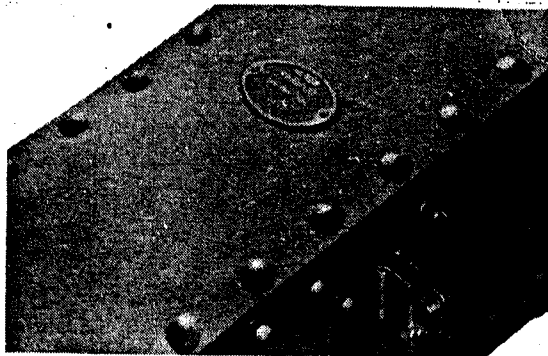

RA PD 37704

Figure 102—Carriage model number

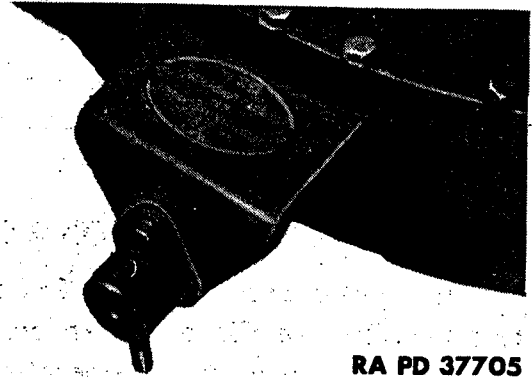

RA PD 37705

Figure 103—Limber serial number

d. Carriage model number. On a metal plate on the upper surface of the right trail several feet from the rear end (fig. 102).

e. Limber serial number. On a metal plate on the upper face of the fifth-wheel locking bracket (fig. 103).

## 69. INSPECTION

The following instructions with reference to the inspections of guns, carriages and limbers should be carefully observed by all concerned:

### Parts to be inspected in order of inspection

### Points to observe

#### a. GUN

(1) The gun as a unit.

(1) Note the general appearance. Test the smoothness of operation of the breech mechanism, both in opening and closing. Test the firing mechanism by firing two primers. Disassemble the breech mechanism and see that it is thoroughly clean. (See (3) below). Note the condition of the bore for bruises in the gas check seat and for burrs or roughness on the leveling plates.

(2) Breech recess and breech threads.

(2) Note whether there are scores or bruises in the threads of the breech recess, and on the breechblock.

### INSPECTION AND ADJUSTMENT

#### Parts to be inspected in order of inspection

#### Points to observe

(3) Breechblock carrier assembly and its allied parts.

(3) While breech mechanism is disassembled, note roughened or scored condition of the firing mechanism housing, hinge pin, rack lock, gear teeth on breechblock, etc. Test the rack lock spring, firing pin spring and firing mechanism block latch spring; if weak or broken, replace.

(4) Percussion hammer.

(4) Note whether the safety lug has been worn so as to allow the snap gage to go over it. If it does, replace the percussion hammer. Note the condition of the percussion hammer operating shaft.

(5) Obturator spindle.

(5) Note whether there is erosion of the vent hole and primer chamber; condition of the obturator spindle; bruised split ring; torn gas check pad; broken or weakened obturator spindle spring. Try several primers in the obturator spindle plug. The primers should extend more than 1/8 inch when pressed in hard with the thumb or finger.

(6) Counterbalance.

(6) Test the mechanism and see that it functions properly at all degrees of elevation. If the counterbalance spring is weak or broken, notify ordnance maintenance personnel.

(7) Recoil indicator.

(7) Note whether it is in place and in good condition.

#### b. CARRIAGE

(1) The carriage as a unit.

(1) Note the general appearance. Note whether the oil plugs are painted red, that a ring has been painted around all oil holes, and that the carriage is painted in accordance with regulations. Note any gloss on the finish or any unnecessarily bright metal that would affect camouflage value.

ICATIONS  
plate on the  
n (fig. 101).

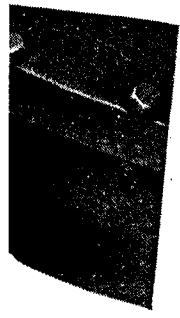

PD 37705

rial

he upper

per face

f guns,  
erned:

Test  
eech  
sing.  
two  
ech-  
ghly  
ndi-  
gas  
on

or  
re-

155-MM GUN MATERIEL, M1917, M1918 AND MODIFICATIONS

Parts to be inspected in  
order of inspection

Points to observe

(2) Recoil mechanism.

(2) Determine whether the proper amount of oil is in both recoil and recuperator systems. Note whether the oil index and the replenisher piston function correctly. Before firing, see that the recoil and recuperator piston rod nuts are screwed tight. When the gun is fired, see that the relief valve in the counter-recoil front head is functioning properly and allowing the air trapped in the cylinder to escape (see par. 16 j).

See that air is escaping from the replenisher piston guide assembled in the rear end of the replenisher (see par. 53 e).

(3) Elevating mechanism.

(3) Note whether the operation is smooth, and whether the mechanism is properly lubricated. Elevate and depress. Note the movement of the connecting rod and that it functions properly to control the variable recoil. Note whether the nut which retains the handwheel is in place.

(4) Traversing mechanism.

(4) Note whether the operation is smooth. Note whether there is excessive backlash, and that the mechanism is properly lubricated. Test clearance between the top and bottom carriages, using a 0.012 inch feeler gage. Adjust for proper clearance (see par. 54 b).

(5) Trails.

(5) Note the condition of the translating racks; that the teeth are not burred or broken. Determine whether the trail hinge pins are properly lubricated. Test the trail locking bolt nuts and the traveling bar clip clamping screws for ease of operation. Check the condition of the spade retaining toggle turnbuckles.

(6) Spades.

(6) Note the general condition of the spades. Note that the swing bolt nuts move freely on the swing bolts.



INSPECTION AND ADJUSTMENT

Parts to be inspected in  
order of inspection

Points to observe

(7) Traveling lock.

(7) Note the general condition. Note that the teeth of the traveling lock pinions are not burred or broken. See that the edges of the traveling lock locking screw nut are sharp, and that the traveling lock locking screw operates smoothly and freely.

(8) Top carriage.

(8) See that pockets are clean and that the drain hole in each pocket is not closed.

(9) Bottom carriage.

(9) See that the drain hole which leads into the axle housing is clear of all obstructions.

M2 and M3

(10) Brake lining.

(10) Through the brake lining checking hole in the brake drum, note the condition of the brake lining; inspect the clearance between the lining and the drum.

(11) Brake chambers.

(11) With the brakes applied, test for leakage with soapsuds around the outer edge and also around the clamping bolts. Check the brake chamber push rod travel; travel should be kept to a minimum, which is approximately  $\frac{7}{8}$  inch, and should not exceed a maximum of  $1\frac{3}{4}$  inches.

(12) Relay-emergency valve.

(12) Test the application-release portion for leakage by charging the carriage reservoir and applying soapsuds to the exhaust port; if there is air leakage with the brakes released, the intake valve is not seating properly; if air leaks with brakes held applied, the relay valve diaphragm is fractured, or is not seating properly. With the reservoir charged, disconnect the emergency hose between the prime mover and limber—the carriage brakes should apply automatically;

## 155-MM GUN MATERIEL, M1917, M1918 AND MODIFICATIONS

Parts to be inspected in  
order of inspection

## Points to observe

- apply soapsuds to the emergency hose or coupling, which has been disconnected, to determine if the emergency valve is seated properly. If the leakage on any of the above tests is more than a 2-inch diameter bubble in five seconds, or if the carriage brakes fail to apply when the emergency hose is disconnected, report to ordnance maintenance personnel.
- (13) Carriage reservoir. (13) Determine whether the carriage reservoir is drained of all moisture.
- (14) Brake air line hose and fittings. (14) With soapsuds, test air line connections under pressure for leakage. Inspect hose couplings and dummy hose couplings.
- (15) Wheels and tires. (15) Check inflation of carriage tires (90 pounds pressure). Raise and rotate wheels to test bearing adjustment and wheel alinement. Note condition of tires.

## M1917A1 and M1918A1

- (16) Gun axle and spring. (16) Note condition of spring shackles and spring shackle pins, and see that they are not scored or stuck tight. Open and close the axle pivot pin cap; see that it latches properly. Note condition of axle where it bears in the axle housing.
- (17) Wheels and tires. (17) Note condition of the rubber; that all torn strips and embedded stones have been removed. Remove the hub cap and see that the gun axle is properly lubricated. Note that all nuts of the brake drum bolts are in place and held by cotter pins.

## c. LIMBER

## M3

- (1) The limber as a unit. (1) Note the general appearance. Note whether limber is painted in accordance with regulations.

### INSPECTION AND ADJUSTMENT

Parts to be inspected in order of inspection

Points to observe

(2) Brake air line hose and fittings.

Check operation of fifth-wheel assembly, fifth-wheel locking pin, drawbar lock pins, drawbar prop assembly and trail clamping bolt pins. Note condition of limber springs. See that all oil fittings are in place, and that moving parts are receiving lubrication.

(2) With soapsuds, test air line connections under pressure for leakage. Inspect hose straps, hose couplings and dummy hose connections.

(3) Wheels and tires.

(3) Check inflation of limber tires (70 pounds). Raise and rotate wheels to test bearing adjustment and wheel alignment. Note condition of tires.

#### M1917A1 and M1918A1

(4) The limber as a unit.

(4) Note general appearance. Note condition of limber springs; that steering mechanism moves freely; that trail clamping bolts and nuts are in good condition; that all oil cups are in place and moving parts receiving lubrication.

(5) Electric brakes.

(5) Note condition of dry cell batteries. Check battery terminals. Check current at brakes. Check ground connections. Check plug and socket for dirty or corroded blades or broken socket. Check controller by connecting both wires to one terminal and seeing if brakes are effective. Check safety switch by pulling the safety switch lever and by listening for the click caused by armature contacting the magnet. Note condition of brake lining on brakes of carriage and limber.

FICATIONS

ve  
ergency hose  
een discon-  
: emergency  
the leakage  
more than a  
ve seconds,  
il to apply  
is discon-  
aintenance

e carriage  
sture.  
line con-  
kage. In-  
my hose

age tires  
d rotate  
ent and  
of tires.

hackles  
e that  
. Open  
e that  
ion of  
using.

; that  
have  
) and  
ubri-  
rake  
cot-

ote  
ice

Section IX

MALFUNCTIONS AND CORRECTION

	Paragraph
Misfire.....	70
Other malfunction of gun.....	71
Malfunction of mount.....	72
Malfunction of air brake system.....	73
Malfunction of electric brake system.....	74

70. MISFIRE

a. A misfire occurs if the piece fails to fire when desired. Failure of the piece to fire is due to one of two causes: failure of the primer to fire or failure of the propelling charge to ignite.

b. General precautions. The following general precautions will be taken in all cases:

(1) The piece will be kept trained on the target or on a safe place in the field of fire.

(2) All persons will be kept clear of the path of recoil until after the breechblock is opened.

(3) When removing the firing mechanism, opening the breech or reaming the vent, the operator will stand clear of the path of recoil and all other persons will be kept from the rear of the breech.

(4) In no case will the breech be opened before the primer is removed.

(5) Whenever a new primer is inserted and another attempt to fire results in failure, all precautions and procedure will be as prescribed for the first failure. The firing of more than two primers in an attempt to ignite the propelling charge usually is not justified.

c. Primer failures. In case the discharge of the primer is NOT heard, the following procedure will be observed:

(1) At least three attempts will be made to fire the primer, the lanyard being pulled with considerable snap.

(2) If a primer net is available, which permits the lifting of the latch and removal of the firing mechanism by a person entirely clear of the path of recoil, the primer may be removed after two minutes have elapsed since the last attempt to fire.

the  
las  
  
w  
w  
b  
  
v

MALFUNCTIONS AND CORRECTIONS

(3) If no primer net is available, no attempt will be made to remove the primer or open the breech until ten minutes have elapsed since the last attempt to fire.

(4) When removing the firing mechanism, the operator will note whether or not the firing mechanism was fully screwed home. The primer will not be hit properly unless the firing mechanism is screwed as far beyond the latch as possible.

(5) The primer, after removal, will be examined to determine whether or not it has fired.

(6) If the primer has fired, a cleaning bit will be run through the vent, another primer will be inserted and another attempt will be made to fire.

(7) If the primer is not fired, the percussion head will be examined and—

(a) If the head has been properly indented, the primer will be handled carefully and disposed of quickly due to the possibility of primer hangfire. A new primer should then be inserted and an attempt made to fire.

(b) If the head has not been properly struck, and if the firing mechanism was found to have been properly seated, the firing mechanism should be inspected for the following faults: dirty or gummy parts; firing pin or firing pin spring broken; firing pin housing or primer holder loosened. A new primer should then be inserted and an attempt made to fire.

d. Propelling charge failures. (1) In case the discharge of the primer IS heard but the propelling charge has failed to explode, no attempt will be made to remove the primer or to open the breech until 10 minutes have elapsed after the firing of the primer.

(2) After 10 minutes, the primer will be removed, a cleaning bit will be run through the vent, another primer will be inserted, and another attempt will be made to fire.

(3) Failure of the propelling charge to ignite indicates an abnormal condition of the charge, such as a missing igniter, igniter end of the charge against the projectile, wet igniter, igniter charge folded over and not accessible to the flash of the primer or failure to remove the igniter protector cap.

Paragraph

- ..... 70
- ..... 71
- ..... 72
- ..... 73
- ..... 74

desired. Failure  
the primer to

cautions will

a safe place

until after

breech or  
recoil and

primer is

tempt to  
described  
attempt

is NOT

er, the

of the  
ear of  
have

71. OTHER MALFUNCTION OF GUN

Malfunction	Cause	Correction
a. Breech mechanism does not operate freely.	a. (1) Lack of lubrication between rack and breech-block carrier. (2) Lack of lubrication and the formation of scores in the threads of the breech-block carrier or in the breech recess.	a. (1) Remove the rack. Clean and lubricate. (2) Disassemble the breech-block and thoroughly clean. If the threads are scored, repair must be made by ordnance maintenance personnel.
b. Threaded sectors of breechblock and breech chamber do not mate.	b. Rack lock failing to function properly.	b. Disassemble the breech-block and thoroughly clean the rack lock. Replace rack lock spring, if weak or broken.
c. Breech will not open or fully close with firing mechanism in place.	c. Safety feature. Firing mechanism safety plunger is operating properly.	c. Remove firing mechanism before attempting to open breech; never insert firing mechanism until breech is closed.
d. Powder fouling or carbon on threads and surfaces of breech-block.	d. Burned gas check pad, or broken or weakened obturator spindle spring.	d. Replace gas check pad or obturator spindle spring.
e. Operating lever does not latch properly.	e. Weak or broken operating lever handle spring.	e. Disassemble operating lever and replace operating lever handle spring.
f. Percussion hammer not working freely.	f. Lack of lubrication and roughness on shaft and shaft bearings.	f. Disassemble, clean and remove roughness; replace shaft, if necessary.

72. MALFUNCTION OF MOUNT

a. Replenisher piston less than $3\frac{15}{16}$ inches (100 mm) from rear face of replenisher.	a. (1) Expansion of oil due to warm weather or continued firing. (2) Accumulation of air in the recoil system. When air accumulates to any great extent after the system has been drained and filled, it is an indication that the replenisher piston packing is defective or that the cylinder wall is leaking.	a. (1) Drain the recoil cylinder until the piston of the replenisher is $5\frac{15}{16}$ inches (150 mm) from the rear face of the replenisher. (2) Refer to ordnance maintenance personnel.
b. Replenisher piston $7\frac{7}{8}$ inches (200 mm) from rear face.	b. Insufficient oil in replenisher.	b. Fill the mechanism until the piston is $5\frac{15}{16}$ inches (150 mm) from the rear face of the replenisher. See paragraph 53-1.
c. Oil leaks from rear of replenisher.	c. Whether or not a serious leak exists must be determined by the position of the replenisher piston and the frequency of refilling required by the recoil system.	c. Oil may drip rapidly, or even run in a stream, from the rear of the replenisher when the gun is elevated, provided the cradle has been at zero elevation for some time. This condition may exist in a normal replenisher. A leak at any packing that does not exceed three drops per minute is not considered serious.

M:  
d. P  
isher  
chang

e.  
les  
(5)

MALFUNCTIONS AND CORRECTIONS

MODIFICATIONS

rection  
move the rack.  
bricate.  
ble the breech-  
roughly clean. If  
re scored, repair  
le by ordnance  
ersonnel.  
le the breech-  
oughly clean the  
place rack lock  
or broken.  
ing mechanism  
ting to open  
ert firing mech-  
h is closed.  
check pad or  
spring.  
operating  
e operating  
lean and re-  
place shaft,  
recoil cyl-  
on of the  
ches (150  
ice of the  
ce main-  
until  
s (150  
of the  
53-I.  
y, or  
n the  
n the  
the  
eva-  
ndi-  
re-  
ck-  
ree  
on-

Malfunction

Cause

Correction

d. Position of replenisher piston does not change during firing.

d. Replenisher piston stuck.

d. Insert a block of hardwood in the rear of the replenisher against the piston end and tap with a hammer. (See par. 53-k.) Clear breather and drain holes, if not open. Never strike the walls of a replenisher with a hammer or any other article. If the replenisher cylinder becomes dented in any way, report to the ordnance maintenance personnel.

e. Oil index projects less than 3/16 inch (5 mm).

e. (1) Loss of reserve oil.  
  
(2) Loss of gas pressure either through the recuperator cylinder front head or past the floating piston.

e. (1) Drain the remainder of the reserve oil and refill. (See par. 53-o.)  
  
(2) Gas escaping by the floating piston is indicated by the emulsified condition of the reserve oil drained off. If, when proceeding to fill the counterrecoil system in the ordinary manner, the oil index does not move out and the pump works easily, the gas pressure has probably been lost. Substantiate this by an attempt to drain the counterrecoil system; oil will not spurt from a mechanism without at least some pressure. Notify ordnance maintenance personnel.

f. Oil index remains stationary when reserve oil is pumped in against evident pressure.

f. The packing is too tight, or the index is broken or locked by some foreign substance.

f. Drain off all reserve oil and refill. While injecting the oil, tap the oil index gently with each stroke of the pump or each turn of the oil screw filler. If the oil index fails to move after 67 strokes of the pump or one and one-half charges with the oil screw filler, then refer the matter to the ordnance maintenance personnel.

g. Oil drips from the counterrecoil rod, recoil rod or control rod stuffing boxes in excess of three drops per minute.

g. (1) Broken springs.  
  
(2) More compression required on springs.  
  
(3) Damaged packing.

g. (1) Report to ordnance maintenance personnel.  
  
(2) Report to ordnance maintenance personnel.  
  
(3) Report to ordnance maintenance personnel.

h. Oil leaks from forward end of the counterrecoil cylinder.

h. Black oil appearing in front of the counterrecoil piston is a normal condition due to lubrication. Clear oil is an indication of a leak due to broken packing springs or lack of compression on the springs.

h. Report a leak of clear oil to ordnance maintenance personnel.

i. Excessive leaks from recuperator and recoil filling and drain plugs.

i. Sticking of valve or defective packing.

i. Report it to the ordnance maintenance personnel.

## 155-MM GUN MATERIEL, M1917, M1918 AND MODIFICATIONS

Malfunction	Cause	Correction
j. Gun will not return to battery.	j. (1) Too much oil in the recoil system. (2) Insufficient oil in the counterrecoil system. (3) Insufficient gas pressure.	j. (1) Reduce the amount of oil in the replenisher to normal. (2) Drain off the reserve oil and refill. (3) Report to ordnance maintenance personnel for investigation.
k. Gun returns to battery with too much shock.	k. (1) Insufficient oil in the recoil system.  (2) Excess oil in the counterrecoil system. (3) Change of viscosity of oil (due to rapid firing). (4) Friction factors of various packings are too low.	k. (1) Refill the replenisher to normal.  (2) Drain counterrecoil reserve and refill to normal. (3) Allow gun to cool.  (4) Report to ordnance maintenance personnel.
l. Gun slow to return to battery (when oil gage is normal).	l. (1) Insufficient gas pressure. (2) Packing exerts too much friction.	l. (1) Report to ordnance maintenance personnel. (2) Report to ordnance maintenance personnel.
m. Uneven and jerky counterrecoil.	m. (1) Too close fit of bearing surfaces, such as the recoil rod piston liner and anti-friction ring bearings. (2) Various bearings surfaces scored. (3) Foreign substances in the oil.	m. (1) Report to ordnance maintenance personnel.  (2) Report to ordnance maintenance personnel. (3) Report to ordnance maintenance personnel.
n. Gun in counterrecoil does not cause the hissing sound of escaping air.	n. Air vents stopped up.	n. Clean the vents in the replenisher piston guide, using a small wire. If air is not escaping from the counterrecoil cylinder front head, notify the ordnance maintenance personnel who will check the relief valve.
o. Gun recoils more than the maximum distance allowable (See chart, par. 53-j.)	o. Insufficient oil in the recoil mechanism.	o. Refill replenisher to normal. If this does not overcome the malfunction, report to ordnance maintenance personnel.
p. Gun does not recoil sufficiently.	p. (1) High viscosity of oil due to low temperature.  (2) Various bearing surfaces scored. (3) Packing exerts too much friction. (4) Malfunction of control rod.	p. (1) Warm the recoil mechanism by firing warming rounds or otherwise. (2) Report to ordnance maintenance personnel. (3) Report to ordnance maintenance personnel. (4) Report to ordnance maintenance personnel.
q. Gun will not elevate to full 35° (when the carriage is placed on level ground).	q. (1) Variable recoil valve turning mechanism jammed. (2) Interference between the elevating worm or top carriage. (3) Interference between cradle and top carriage. (4) Malfunction of the elevating mechanism.	q. (1) Report to ordnance maintenance personnel.  (2) Report to ordnance maintenance personnel.  (3) Report to ordnance maintenance personnel. (4) Report to ordnance maintenance personnel.

73.

M

a. r  
termi

b.

c.



MALFUNCTIONS AND CORRECTIONS

73. MALFUNCTION OF AIR BRAKE SYSTEM

Malfunction Cause Correction

- a. No brakes, or intermittent brakes.
  - a. (1) Leak in air line; loose or damaged connection or coupling.
    - (2) Leaking brake chamber or fractured brake chamber diaphragm.
    - (3) Malfunction of relay portion of relay emergency valve.
    - (4) Moisture in carriage reservoir.
  - a. (1) Test with soapsuds as described in paragraph 69-b (14), c (2). Tighten loose connections; replace damaged part or length of air line.
    - (2) Test with soapsuds. (See par. 69-b (11).) Report to ordnance maintenance personnel.
    - (3) Test with soapsuds. (See par. 69-b (12).) Report to ordnance maintenance personnel.
    - (4) Remove drain plug in bottom of carriage reservoir; drain; replace plug.
- b. Weak brakes.
  - b. (1) Insufficient travel of brake chamber push rods.
  - (2) Worn, glazed or greasy brake lining.
  - (3) Brakes out of adjustment.
  - (4) Insufficient air pressure at brakes.
  - b. (1) Adjust brakes. (See par. 55-b.)
  - (2) Report to ordnance maintenance personnel.
  - (3) Adjust brakes. (See par. 55-b.)
  - (4) Report to ordnance maintenance personnel.
- c. Grabbing brakes.
  - c. (1) Loose or worn wheel bearings.
  - (2) Only one brake functioning.
  - c. (1) Adjust bearings. (See par. 54-e.)
  - (2) If air line hose or connections leak, tighten or replace; otherwise report to ordnance maintenance personnel.
- d. Locked brakes.
  - d. (1) Air line hose crossed by connecting couplings of service and emergency air lines.
  - (2) No air in service air line.
  - d. (1) Empty carriage reservoir by opening carriage reservoir cock (at one end of reservoir).
  - (2) Couple to air source on prime mover or open carriage reservoir cock.
- e. Emergency brake does not function when air line is disconnected from air in carriage reservoir.
  - e. Malfunction of emergency portion of relay-emergency valve.
  - e. Report to ordnance maintenance personnel.

74. MALFUNCTION OF ELECTRIC BRAKE SYSTEM

- a. No brakes or intermittent brakes.
  - a. (1) Broken wire in circuit.
  - (2) Controller defective.
  - (3) Poor connections.
  - (4) Broken wire on magnet.
  - a. (1) Check entire wiring for broken wires.
  - (2) Short out the controller by connecting both wires to one terminal and see if brakes are effective.
  - (3) Check, clean, and tighten all connections at brake, controller, load control, and socket.
  - (4) If broken wire is on outside of magnet, repair, if possible. If no current flows through magnet, notify ordnance maintenance personnel.

MODIFICATIONS

rection

duce the amount of  
lenisher to normal  
off the reserve oil

to ordnance main-  
nnel for investi-

l the replenisher

unterrecoil re-  
to normal.  
to cool.

rdnance main-  
el.

to ordnance  
nnel.  
rdnance main-  
l.

to ordnance  
nnel.

nance main-  
ance main-

in the re-  
le, using a  
t escaping  
il cylinder  
rdnance  
l who will

to nor-  
vercome  
t to ord-  
rsonnel.

recoil  
arming

main-  
main-  
main-

ance

ain-

in-

in-

# 155-MM GUN MATERIEL, M1917, M1918 AND MODIFICATIONS

## Malfunction

## Cause

## Correction

- |                     |   |  |
|---------------------|---|--|
|                     | (5) Poor ground condition in circuit.   | (5) Clean up and tighten connections.  |
|                     | (6) Defective plug or socket.   | (6) Check plug and socket for loose connections, dirty or corroded blades, or a broken socket. Repair or replace with new socket.  |
| b. Weak brakes.     | b. (1) Glazed magnet facing.  | b. (1) Roughen the facing of the magnet with coarse emery cloth.   |
|                     | (2) Grabbing brakes.  | (2) Check and see if stop lights have been connected into the brake circuit by mistake.  |
|                     | (3) Wire broken in insulation. Loose connection. Poor contact at load control. (See par. 56-c.) | (3) Check wiring for defective parts. Short out load control.  |
|                     | (4) Insufficient current.   | (4) Insufficient current may be caused by poor connections at the brake, controller and load control, ground, or plug and socket. Clean up and tighten all connections, check plug and socket for corroded or dirty blades. Repair or replace with new socket. |
| c. Brakes grabbing. | c. (1) Loose or worn wheel bearings.  | c. (1) Tighten or replace bearings.  |
|                     | (2) Only one brake working.   | (2) Check current at the brakes by using ammeter.  |
|                     | (3) Contactor arm in controller pitted.   | (3) Smooth out contactor arm with fine emery cloth.  |

Ger  
Dis  
As  
Di  
As  
D  
A  
L  
A  
I

## Section X

## DISASSEMBLY AND ASSEMBLY

	Paragraph
General.....	75
Disassembly of breech mechanism.....	76
Assembly of breech mechanism.....	77
Disassembly of operating lever.....	78
Assembly of operating lever.....	79
Disassembly of percussion mechanism.....	80
Assembly of percussion mechanism.....	81
Disassembly of firing mechanism.....	82
Assembly of firing mechanism.....	83
Disassembly of counterbalance regulating screw.....	84
Assembly of counterbalance regulating screw.....	85
Removal and replacement of oblique spindles.....	86
Disassembly of elastic suspension.....	87
Assembly of elastic suspension.....	88
Disassembly and assembly of wheels.....	89
To remove pneumatic tire and tube.....	90
To install pneumatic tire and tube.....	91

## 75. GENERAL

a. Cleaning and inspection, and incidents of use and breakage, make necessary the disassembly and assembly of the breech mechanism and various parts of the carriage and limber. This work comes under two headings—that which can be performed by the battery personnel with the equipment furnished; and that which must be performed by ordnance maintenance personnel.

b. The battery personnel may, in general, do such dismounting as is required for the installation of the spare parts carried by the battery, and as is required for thorough inspection, cleaning and lubrication. Such work should be done in the manner prescribed with the tools at their disposal.

c. Any difficulty which cannot be remedied by the prescribed methods will be brought to the attention of the ordnance maintenance personnel. Battery personnel will not attempt to dismount the gun from the cradle, or the cradle from the carriage, or to do any work on the recoil mechanism (other than prescribed in this manual), due to the impracticability of furnishing the organization with necessary equipment for the performance of this work.

## 155-MM GUN MATERIEL, M1917, M1918 AND MODIFICATIONS

d. No filing of sighting or gun parts will be done by the battery personnel except as outlined herein. Filing is to be done only by order of the battery commander.

e. The use of wrenches which do not fit snugly on the parts should be avoided. They will not only fail to tighten the parts properly, but will damage the corners of nuts. There is also danger of spreading the wrenches and rendering them useless.

f. It is desirable to complete the subassembling of units before attempting the assembly of the units of the gun. In all assembling, the bearings, sliding surfaces, threads, etc., should be clean and lubricated with SAE 10 engine oil for temperatures below 32 F., and SAE 20 engine oil for temperatures above 32 F.

### 76. DISASSEMBLY OF BREECH MECHANISM

a. The breechblock and breech mechanism may be removed, as an assembly, at any time without disturbing other parts of the gun and carriage, except when the gun is in traveling position and the spades are in place. It is done merely by detaching the counterbalance unit and removing the breechblock carrier hinge pin (see par. 76 b and 76 c). While the breechblock may be disassembled after being removed from the gun, it is generally more convenient to disassemble it on the gun.

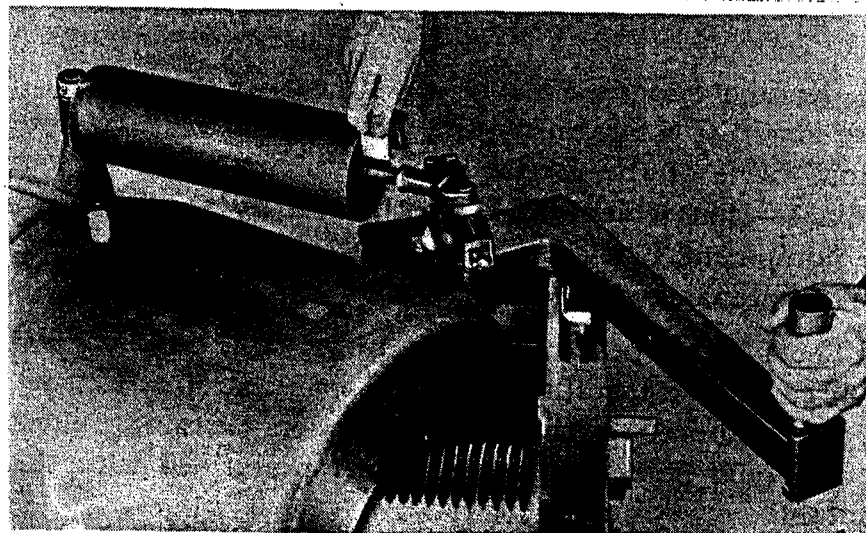

RA PD 37698

*Figure 104—Placing the counterbalance tension rod spacer*

b. Detach counterbalance. Open the breech and place the counterbalance tension rod spacer (fig. 104) on the counterbalance tension rod between the shoulder on the rod and the cylinder head. It may be necessary to adjust the regulating screw to provide enough space

on t  
deta  
bala

### DISASSEMBLY AND ASSEMBLY

on the rod to install the spacer. Close the breech enough to permit detaching the eye in the counterbalance tension rod from the counterbalance regulating nut.

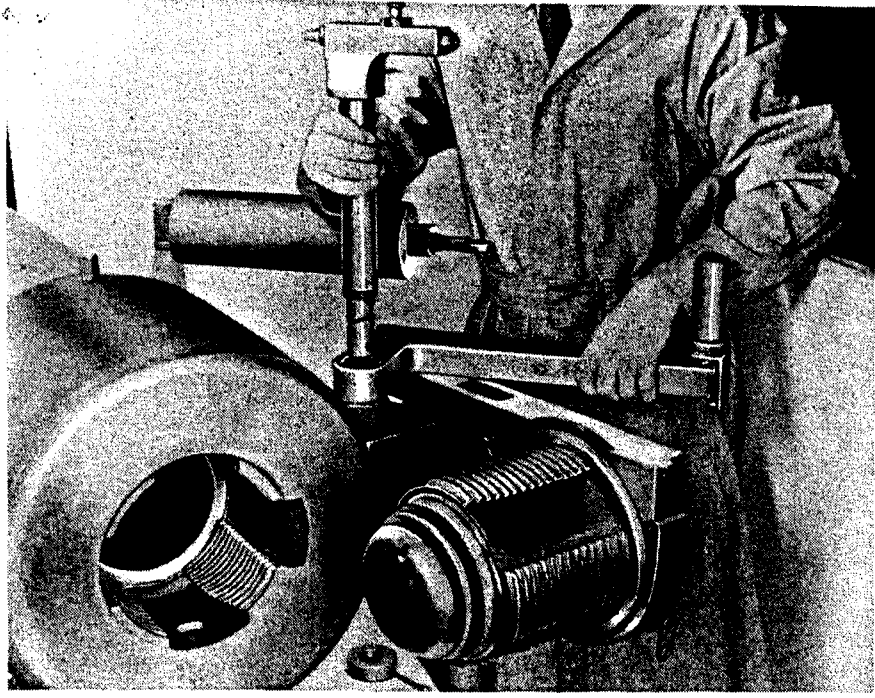

RA PD 37241

Figure 105—Removing the breechblock carrier hinge pin

c. Remove breechblock carrier hinge pin. Remove hinge pin collar detent and hinge pin collar from the lower end of operating lever to prevent its dropping (fig. 105). Do not lose hinge pin driving washer. Reinstall hinge pin temporarily while working on breech mechanism, pinning the carrier in place, if disassembly is to be done at the gun.

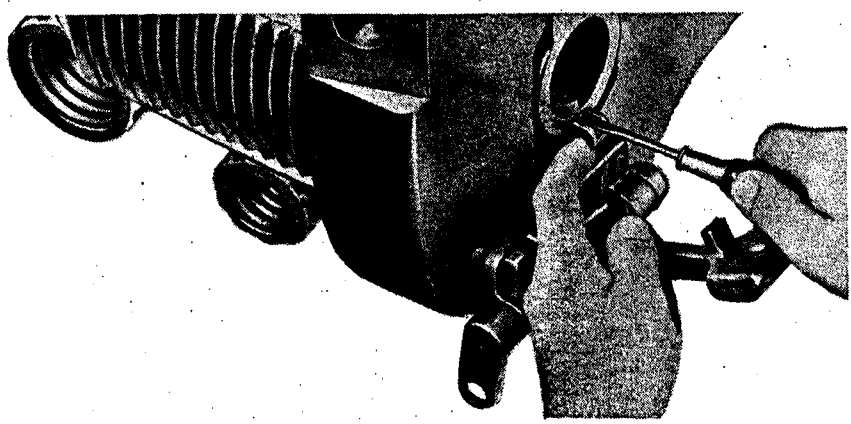

RA PD 37219

Figure 106—Releasing the firing mechanism housing key spring

d. Remove obturator spindle. Depress firing mechanism hous-

MODIFICATIONS

done by the battery  
done only by order

on the parts should  
parts properly, but  
of spreading the

g of units before  
l assembling, the  
n and lubricated  
d SAE 20 engine

e removed, as  
of the gun and  
d the spades  
rbalance unit  
b and 76 c).  
removed from  
on the gun.

ce the  
alance  
ad. It  
space

### 155-MM GUN MATERIEL, M1917, M1918 AND MODIFICATIONS

ing key spring and pull out firing mechanism housing key as far as possible (fig. 106). Using the obturator spindle face spanner wrench, unscrew and remove the obturator spindle by turning to the left (fig. 107).

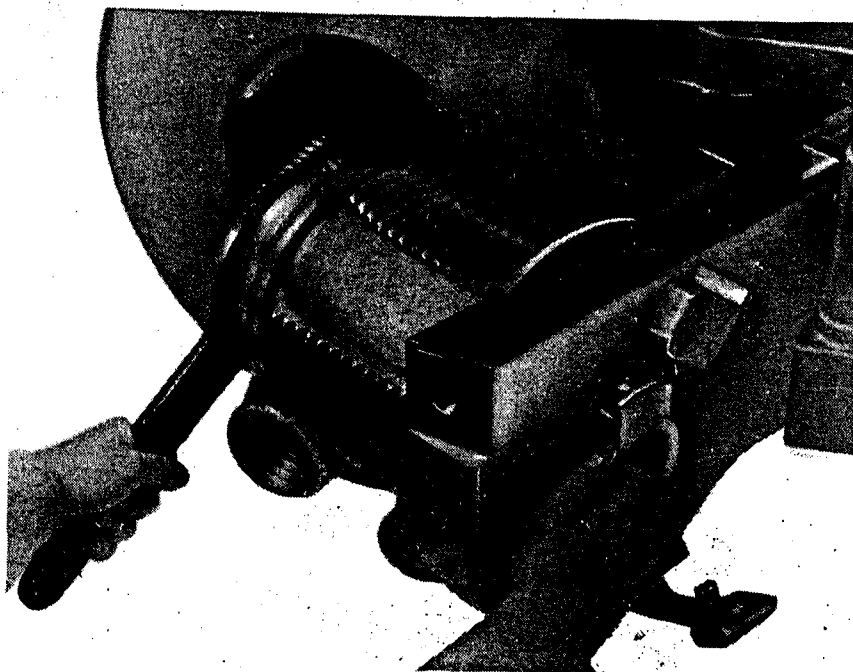

RA PD 37220

*Figure 107—Removing the obturator spindle*

In removing them with the obturator spindle, take care not to injure the obturator front split ring, gas check pad, rear split ring, inner ring and filling-in disk, which are assembled on the obturator spindle.

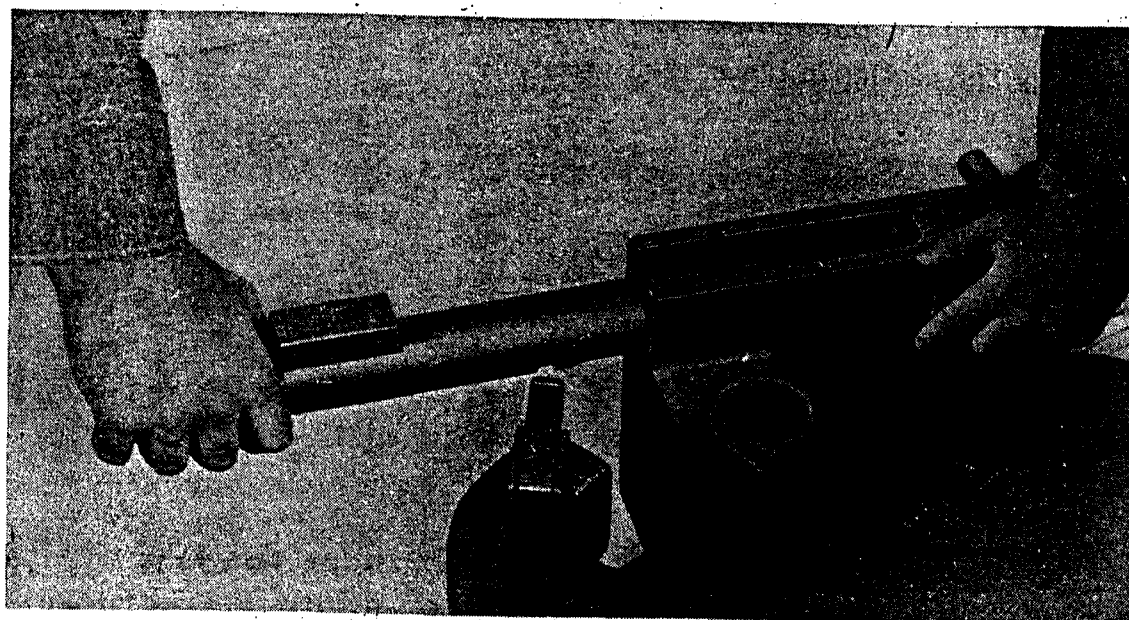

RA PD 37223

*Figure 108—Releasing and removing the breechblock rack*

## DISASSEMBLY AND ASSEMBLY

e. Remove firing mechanism housing. Draw firing mechanism from breechblock carrier (fig. 107). With it will come the firing mechanism housing key and the firing mechanism safety plunger, the latter being assembled to the housing. Remove firing mechanism safety plunger and spring by unscrewing retaining screw.

f. Remove breechblock rack. With a finger, fully depress the breechblock rack lock (fig. 108), and pull the rack out of the breechblock carrier. Lift out rack lock and rack lock spring.

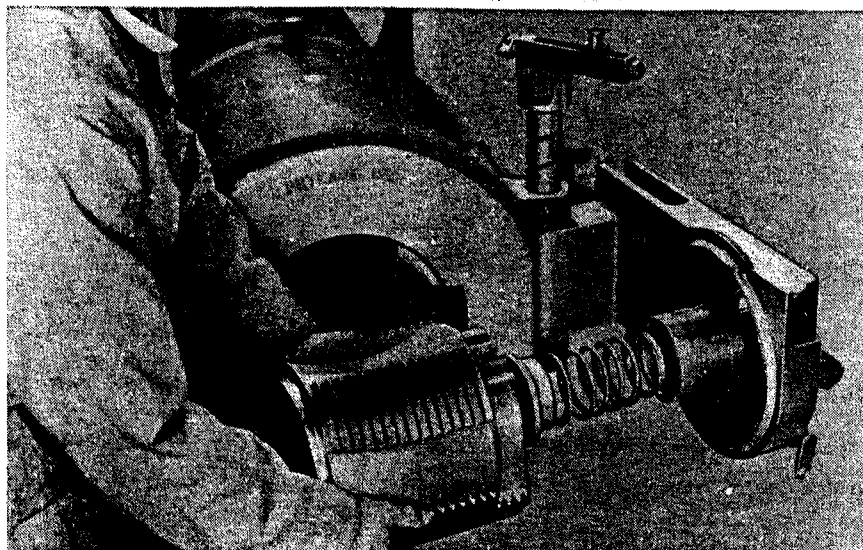

RA PD 37234

*Figure 109—Removing the breechblock*

g. Remove breechblock. Unscrew breechblock from carrier by turning it approximately four revolutions to the right. Remove the obturator spindle spring front seat and the obturator spindle spring supporting washer from the bore of the breechblock. Remove the obturator spindle spring rear seat and the obturator spindle spring from the carrier hub.

h. Remove breechblock carrier. Remove the breechblock carrier hinge pin and dismount the breechblock carrier.

## 77. ASSEMBLY OF BREECH MECHANISM

a. Install breechblock carrier. Hold the hinge pin driving washer on the bottom face of the breechblock carrier lug while setting the breechblock carrier lug between the hinge lugs on the breech ring. Install the hinge pin temporarily.

b. Install obturator spindle spring and seats. Place the obturator spindle spring rear seat and the obturator spindle spring in the breechblock carrier hub. The flange of the rear seat must be toward the spring. Place the obturator spindle front seat (with flange down) and

155-MM GUN MATERIEL, M1917, M1918 AND MODIFICATIONS  
the obturator spindle supporting washer (fig. 110) into the breechblock.

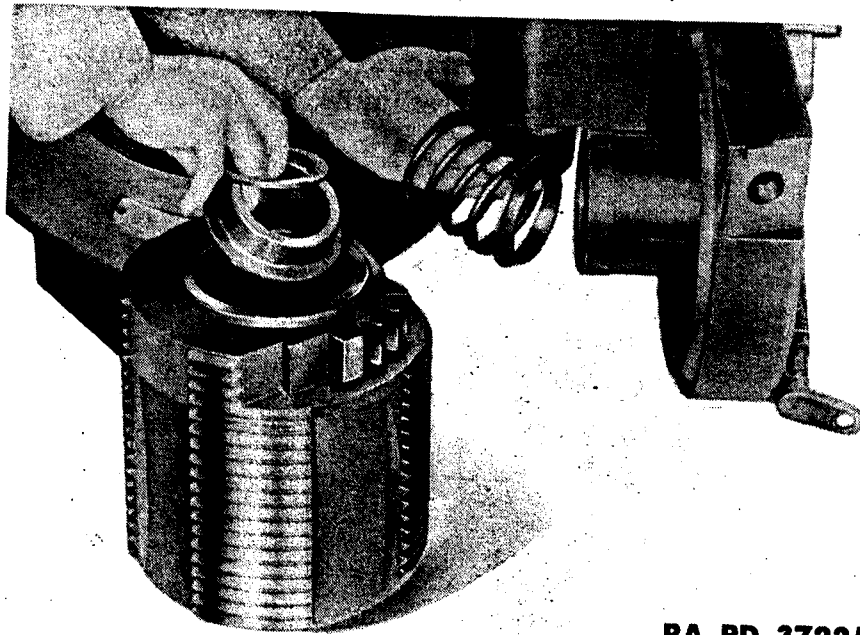

RA PD 37225

*Figure 110—Installing the obturator spindle spring, washer and seats*

c. Install breechblock. Place the breechblock on the breechblock carrier hub. Pass a rod or stick through the breechblock bore to keep the spring and seats in alignment while screwing the breechblock to the left as it has left hand threads (fig. 111).

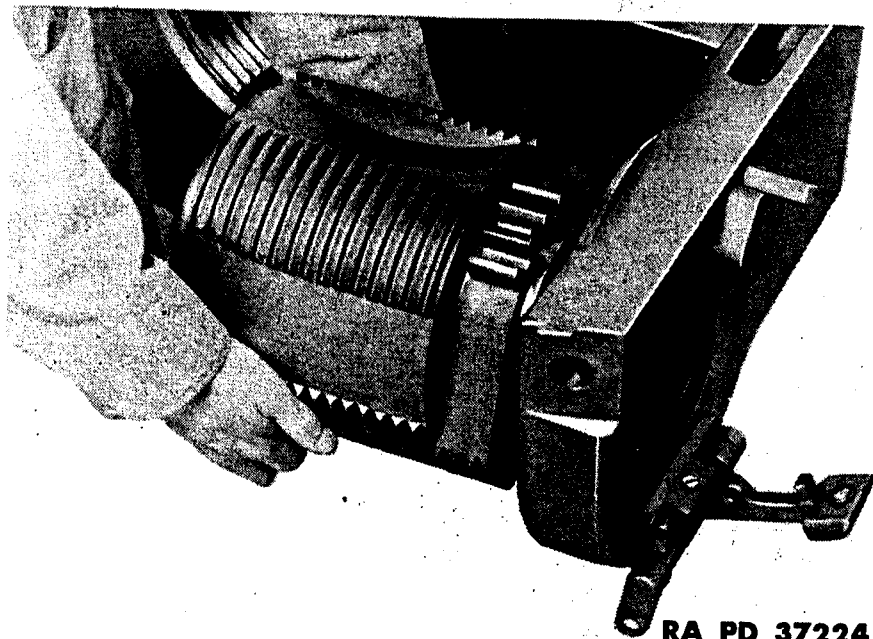

RA PD 37224

*Figure 111—Installing the breechblock*

d. Install breechblock rack. Install the rack lock spring and rack lock. Turn the breechblock to line up the assembling line on the breechblock with the line on the breechblock carrier (fig. 112). Depress



### DISASSEMBLY AND ASSEMBLY

MODIFICATIONS  
to the breechblock.

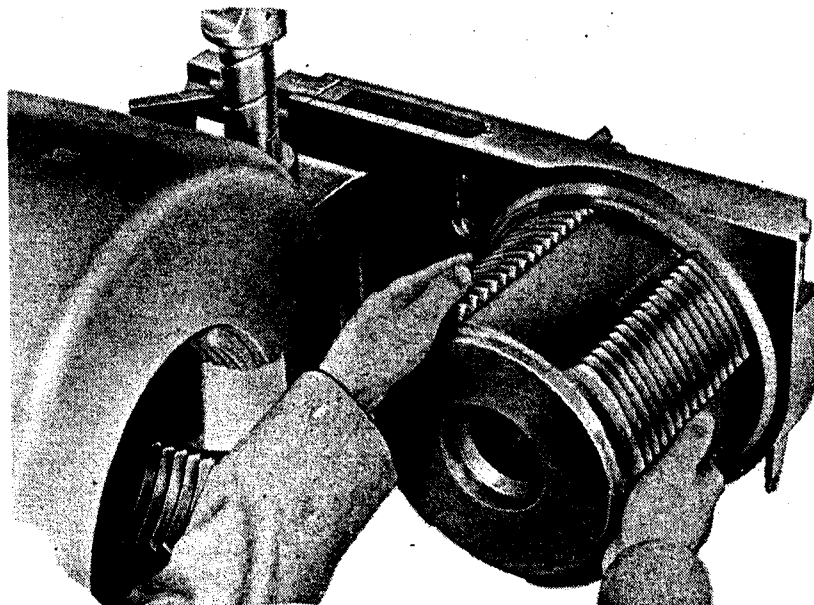

RA PD 37236

**Figure 112—Alining the breechblock and breechblock rack**

the rack lock and push the rack, with teeth down, into the recess in the breechblock carrier. Push the rack until the line on the rack is about one-fourth inch in advance of the line on the breechblock carrier. Depress the rack lock fully and turn the breechblock to the right (clockwise) as far as possible. This will cause the breechblock gear teeth to mesh with those of the rack.

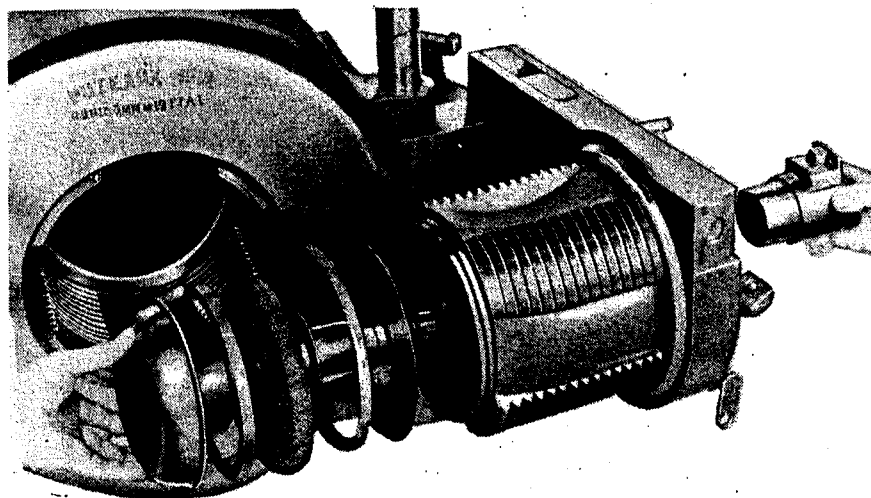

RA PD 37238

**Figure 113—Installing the firing mechanism housing (with safety plunger in place), and obturator spindle assembly**

e. Install firing mechanism housing. Install the firing mechanism safety plunger spring and plunger in the firing mechanism housing and secure with the firing mechanism housing screw. Assemble the

7225  
id seats  
the breech-  
ock bore to  
breechblock  
  
and  
the  
press

## 155-MM GUN MATERIEL, M1917, M1918 AND MODIFICATIONS

firing mechanism housing and the firing mechanism key, and install them in the breechblock carrier with the key in the "out" position (fig. 113).

f. **Install obturator spindle.** In the following order, assemble the front split ring, gas check pad, rear split ring, inner ring and filling-in disk, to the obturator spindle (fig. 113). Pass the obturator spindle through the bore of the breechblock, rotating it to the right to engage its threads with those in the firing mechanism housing. Turn the obturator spindle in tight. Depress the firing mechanism housing key spring, and at the same time, press in on the key, turning the obturator spindle in either direction until the key enters the slot in the end of the obturator spindle as the spindle reaches its final position. This locks the obturator spindle and prevents it from rotating.

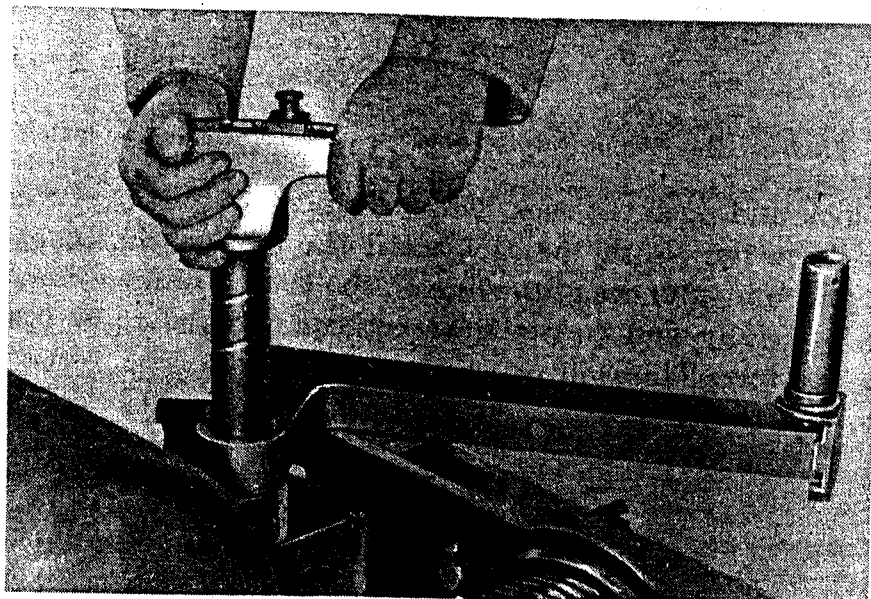

RA PD 37215

*Figure 114—Installing the breechblock carrier hinge pin*

g. **Install breechblock carrier hinge pin.** Remove the breechblock carrier hinge pin (if it has been temporarily installed), and mount the operating lever assembly in position on the breechblock carrier, after turning the breechblock to the left to the open position. Lubricate and install the breechblock carrier hinge pin (fig. 114), tapping it in place with a block of wood, if necessary. Install the hinge pin collar and detent. The counterbalance regulating screw unit at the top of the hinge pin should be positioned with the threaded end of the regulating screw pointing toward the breechblock.

h. **Attach counterbalance.** Close the breechblock carrier far enough to permit attaching the counterbalance tension rod (flat side down) to the counterbalance regulating nut (fig. 115). Open the breechblock carrier and remove the counterbalance tension rod spacer. When

MODIFICATIONS  
a key, and install  
the "out" position

g order, assemble  
r ring and filling-  
obturator spindle  
: right to engage  
Turn the obtura-  
sing key spring,  
bturator spindle  
of the obturator  
s the obturator

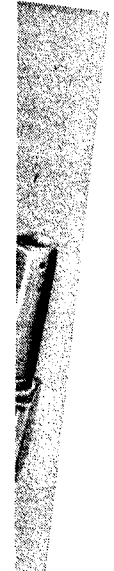

15  
e breech-  
ad mount  
: carrier,  
ubricate  
ng it in  
n collar  
p of the  
ulating  
ier far  
at side  
reech-  
When

## DISASSEMBLY AND ASSEMBLY

77-78

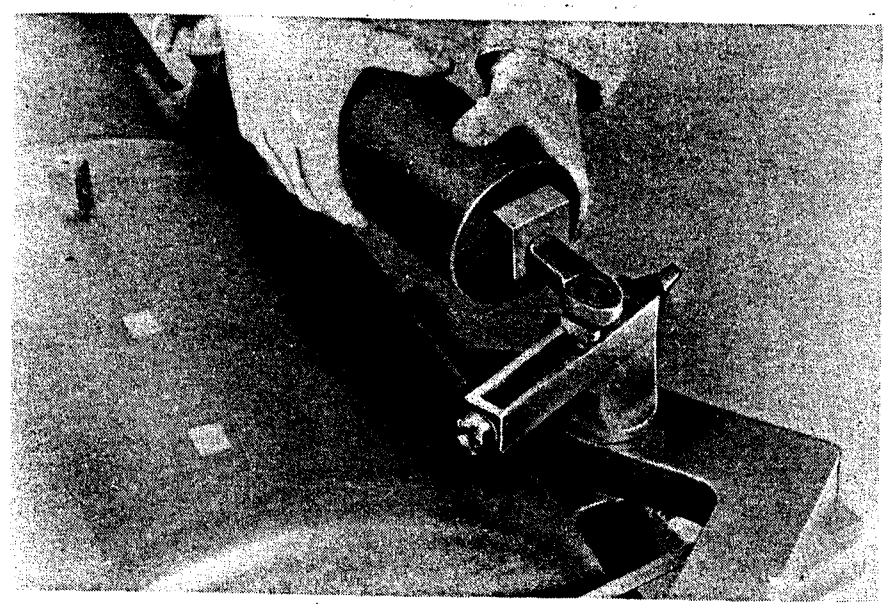

RA PD 37200

*Figure 115—Attaching the counterbalance*

the hinge pin is properly assembled, the counterbalance holds the breech mechanism open and assists its closing.

### 78. DISASSEMBLY OF OPERATING LEVER

a. Detach the counterbalance (par. 76 b). Remove the breech-block carrier hinge pin (par. 76 c). Dismount the operating lever by lifting it out of position.

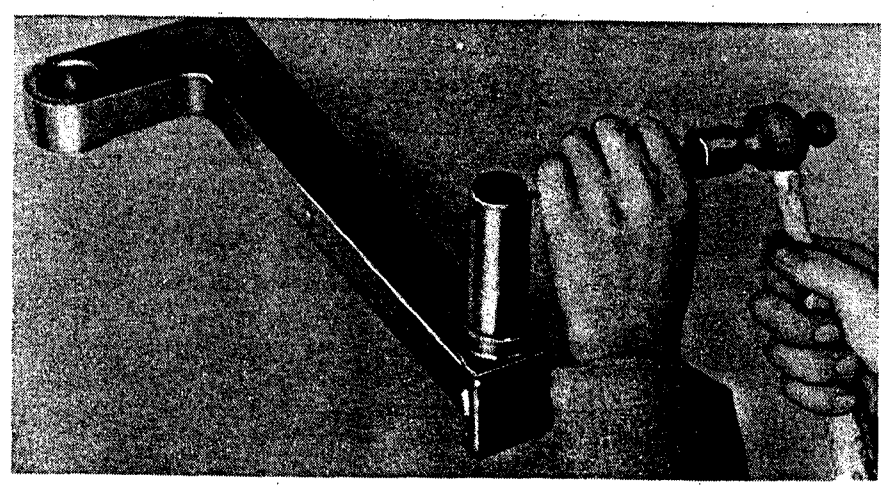

RA PD 37217

*Figure 116—Driving out the operating lever handle lock pin*

b. Drive out the locking pin through the holes in the operating handle (fig. 116). Unscrew the handle retaining nut in the top of the handle. Remove the operating lever handle sleeve and spring. Remove the operating lever latch trunnion screw. Move the operating lever

### 155-MM GUN MATERIEL, M1917, M1918 AND MODIFICATIONS

latch toward the end of the operating lever opposite the handle and dismount the operating lever handle. Remove the latch by pulling it out of the operating lever from the handle end.

#### 79. ASSEMBLY OF OPERATING LEVER

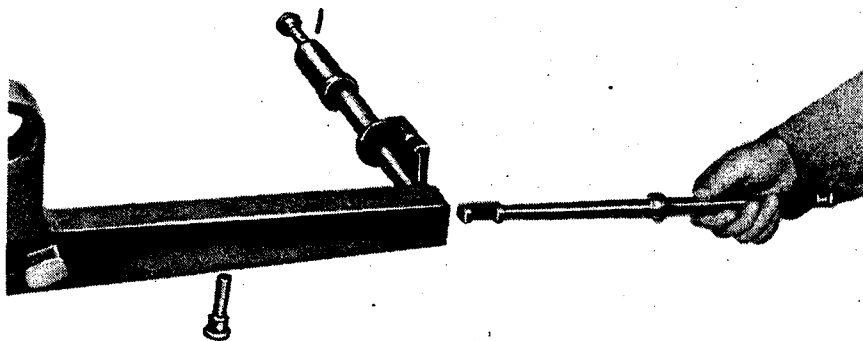

RA PD 37239

*Figure 117—Installing the operating lever latch*

a. Install the operating lever latch inside the operating lever with the round end toward the handle and the slot at the other end toward the bottom (fig. 117). Install the handle, the handle sleeve, the spring and the handle nut. Line up the hole in the handle with the holes in the sleeve and insert the retaining pin.

b. Install operating handle and breechblock carrier hinge pin (see par. 77 g). Attach counterbalance (see par. 77 h).

#### 80. DISASSEMBLY OF PERCUSSION MECHANISM

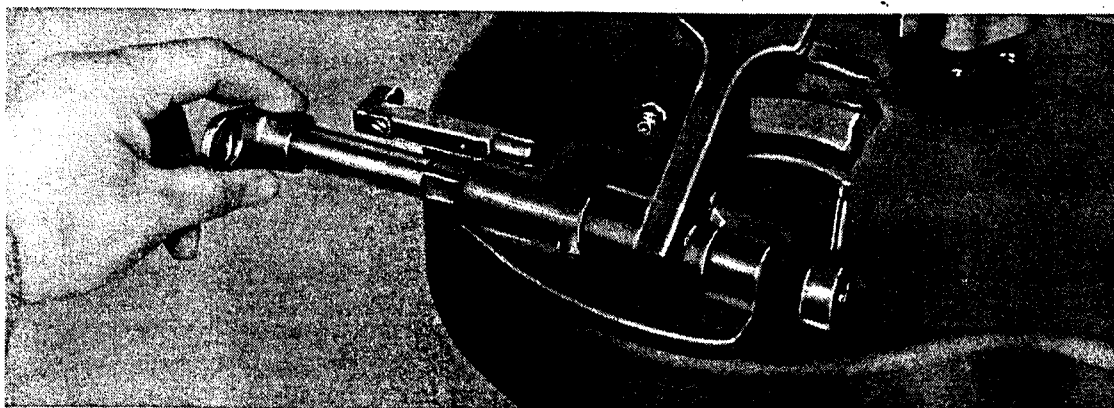

RA PD 37232

*Figure 118—Removing the percussion hammer operating shaft*

Remove the percussion hammer operating shaft collar detent and remove the percussion hammer operating shaft collar. Hold the per-

**DISASSEMBLY AND ASSEMBLY**

percussion hammer and remove the percussion hammer operating shaft (fig. 118). Remove the percussion hammer lock bolt spring screw and withdraw the percussion hammer lock bolt and percussion hammer lock bolt spring. The percussion hammer operating shaft housing is permanently assembled to the breechblock housing and is not to be removed by the battery personnel.

**81. ASSEMBLY OF PERCUSSION MECHANISM**

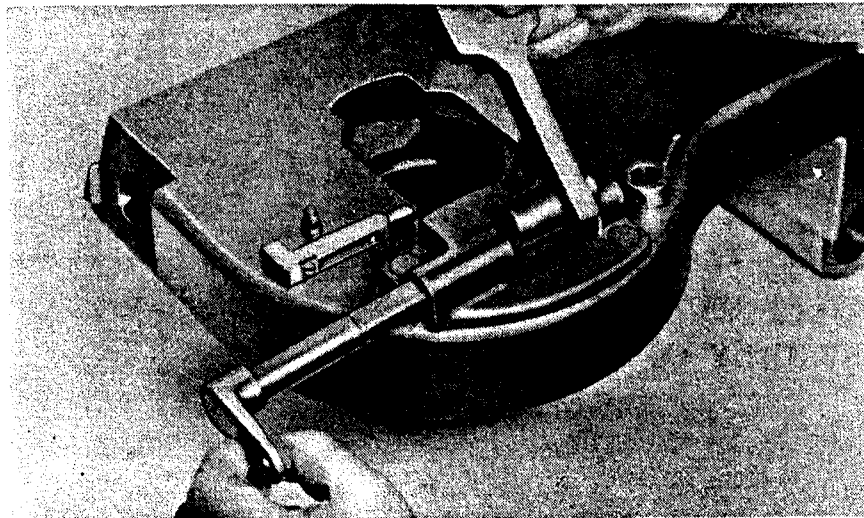

**RA PD 37228**

**Figure 119—Installing the percussion hammer in its pocket**

Set the hub of the percussion hammer in the pocket of the percussion hammer operating shaft housing. Pass the percussion hammer operating shaft through the housing and the hammer (fig. 119). Install the percussion hammer operating shaft collar and its detent. Set the percussion hammer lock bolt spring in the lock bolt and secure it with its screw. Insert the percussion hammer lock bolt into its rectangular-shaped hole, keeping the percussion hammer lock bolt spring facing downward. Screw the percussion hammer lock bolt screw into its seat on the top of the percussion hammer operating shaft housing.

**82. DISASSEMBLY OF FIRING MECHANISM**

Remove both socket head set screws from the firing mechanism with the 1/8-inch socket head set screw wrench. Do not lose the shoe under the set screw for the firing pin housing. Unscrew the firing pin housing with the firing mechanism (teat) wrench, and remove the firing pin and firing pin spring. Unscrew the primer holder, which has left-hand threads and must be turned to the right (clockwise) to remove, and remove the firing pin guide (fig. 120).

IFICATIONS  
he handle and  
by pulling it

9  
lever with  
d toward  
he spring  
les in the

pin (see

7232

and  
per-

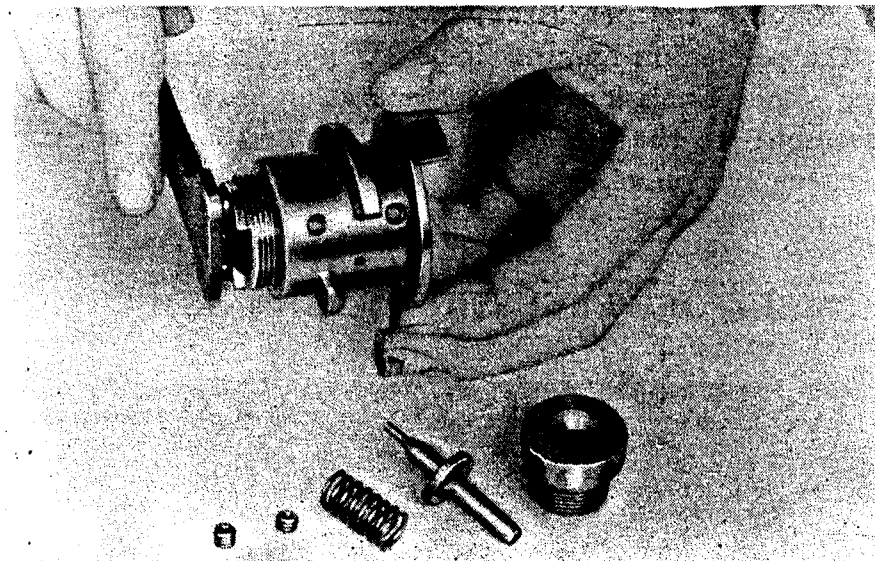

RA PD 37247

*Figure 120—Removing the primer holder from the firing mechanism.  
Firing pin and spring may be removed or inserted from either end*

### 83. ASSEMBLY OF FIRING MECHANISM

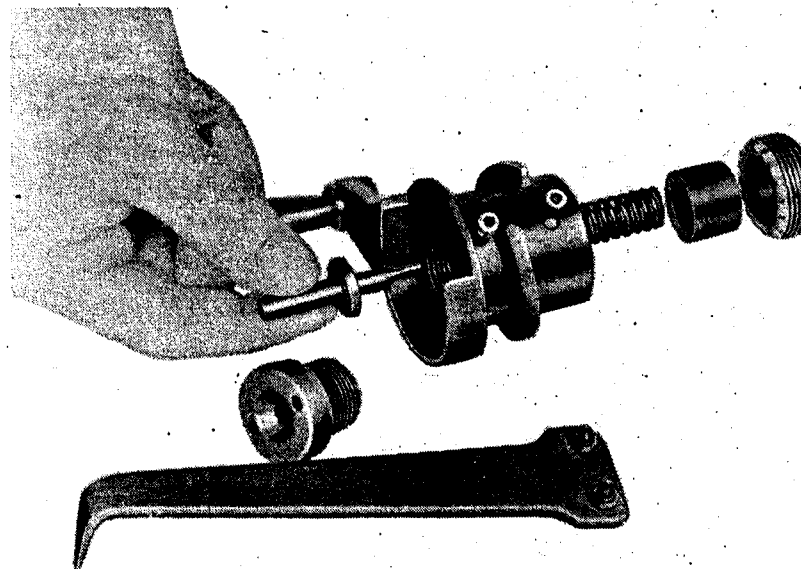

RA PD 37246

*Figure 121—Assembling the firing mechanism*

- a. Install the firing pin guide and the primer holder, screwing the holder in tightly. The primer holder must be turned to the left (counterclockwise) to install. Aline the nearest serration on the primer holder in the center of the set screw hole. Insert the firing pin spring and the firing pin, making sure that the small end of the firing pin is toward the primer holder (fig. 121). Screw in the firing pin housing.
- b. Install both socket head set screws, placing the shoe (to pro-

tect  
be n  
scre  
belo

84.

lati  
scr  
reg

85.

**DISASSEMBLY AND ASSEMBLY**

ject the threads) under the set screw for the firing pin housing. It may be necessary to tighten or to loosen the primer holder to seat the set screw properly. When the set screws are seated, they must be flush or below the outside of the firing mechanism block.

**84. DISASSEMBLY OF COUNTERBALANCE REGULATING SCREW**

Withdraw the cotter pin from the end of the counterbalance regulating screw. Remove the counterbalance regulating screw nut and unscrew the counterbalance regulating screw from the counterbalance regulating nut.

**85. ASSEMBLY OF COUNTERBALANCE REGULATING SCREW**

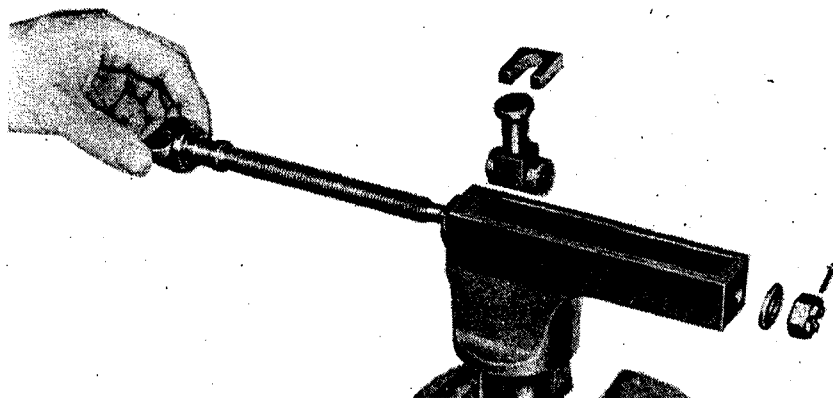

**Figure 122—Assembling the counterbalance regulating screw**

Set the counterbalance regulating nut in the top of the hinge pin. Pass the counterbalance regulating screw through its bushing and into the counterbalance regulating nut until the flange on the screw abuts the one on the bushing. Assemble successively to the other end of the screw, the counterbalance regulating screw washer, nut and cotter pin (fig. 122).

**86. REMOVAL AND REPLACEMENT OBLIQUE SPINDLES**

a. The upper ends of the elevating and traversing oblique spindles fit elongated sockets which permit their being raised to disengage their lower ends, after which the lower end is swung to one side, and the oblique spindle is lowered until free at the upper end (fig. 123). A bronze plunger in each upper squared socket is forced downward by a coiled spring, and bears against the top of each oblique spindle to hold it in place in the connection below.

b. The ends of the socket springs are expanded so that the pressure

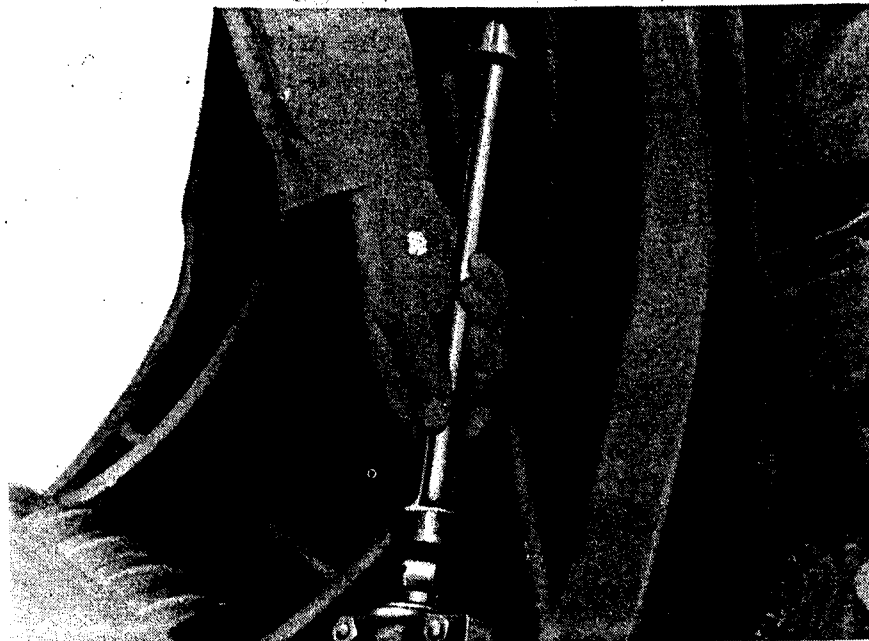

RA PD 37348

**Figure 123—Removing the elevating oblique spindle**

of the end coils will support the spring sockets when the oblique spindles are removed. The oblique spindle spring sockets can be pulled out, without difficulty, with a pair of pliers. These parts must not be omitted in assembling, or the oblique spindle may become lost. Clean and lightly oil the bearing surfaces before assembling. Removal of the oblique spindles exposes oil holes in the heads of the parts below.

c. Except for the removal and replacement of the handwheels, no further dismounting of the elevating and traversing mechanisms should be performed by the battery personnel.

## 87. DISASSEMBLY OF ELASTIC SUSPENSION

a. Raise the rear ends of the trails to the limber, or higher, to obtain sufficient room to work under the bottom carriage. Remove the retaining slotted nut and the adjusting nut locking strap, and with 77-mm box wrench (hexagonal spring suspension adjusting nut), unscrew the spring suspension adjusting nut until the top carriage rests on the bottom carriage.

b. Support the elastic suspension housing by blocking underneath, remove the three elastic suspension housing bolt nuts, and lower the elastic suspension housing, with its contained parts, out of the elastic suspension housing cover (fig. 124). The weight of the housing and contents is about 40 pounds.

c. With the housing dismounted, all contained parts are easily disassembled and replaced without specific instructions. It should be noted, however, that the eight Belleville springs are assembled in pairs



## DISASSEMBLY AND ASSEMBLY

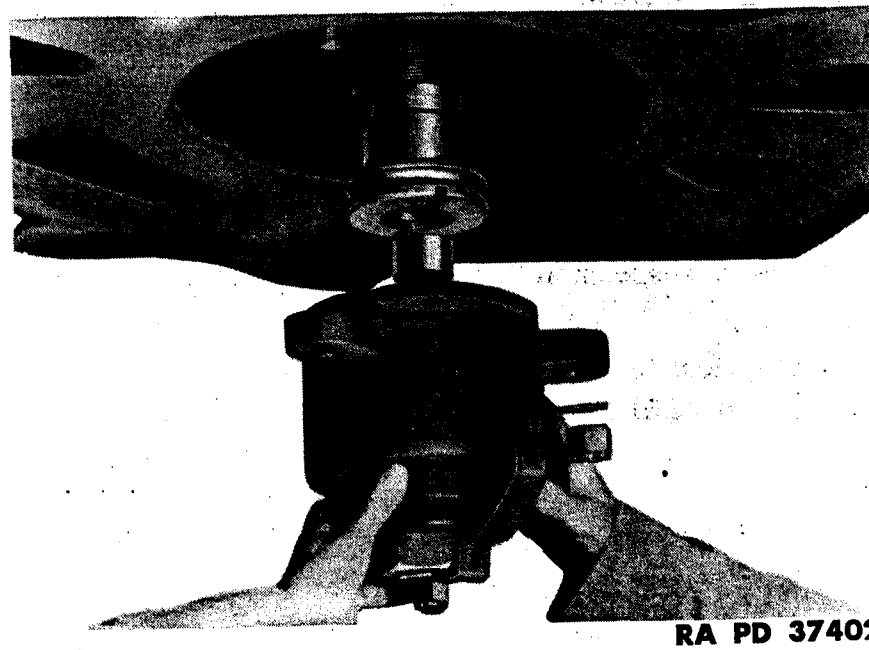

RA PD 37402

Figure 124—Disassembly of the elastic suspension

with the concave surfaces facing each other. When assembled, each pair will rest on the convex surface of the other pair as shown in fig. 126.

d. The upper pivot may remain suspended in the pivot bolt by suction. It will not need to be replaced unless badly worn, in which case the ordnance maintenance personnel will be notified.

## 88. ASSEMBLY OF ELASTIC SUSPENSION

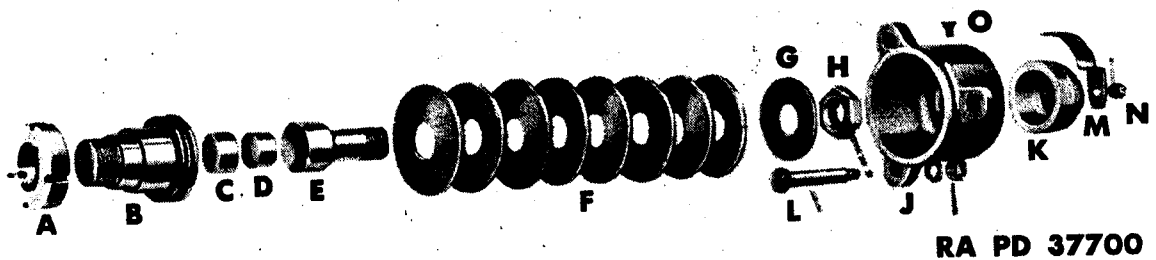

RA PD 37700

Figure 125—Exploded view of the elastic suspension

- |   |                                      |   |  |
|---|--------------------------------------|---|--|
| A | Pivot bolt nut                       | G | Belleville spring support washer         |
| B | Pivot bolt                           | H | Lower pivot crown nut                    |
| C | Upper pivot                          | J | Elastic suspension housing               |
| D | Step                                 | K | Spring suspension adjusting nut and stud |
| E | Lower pivot                          |   |  |
| F | Four pairs (8) of Belleville springs |   |  |

## 155-MM GUN MATERIEL, M1917, M1918 AND MODIFICATIONS

- L Three elastic suspension bolts, N Adjusting nut stud nut washers and nuts  
 M Adjusting nut locking strap O Adjusting nut locking strap guide pin

a. To assemble the elastic suspension housing to the bottom carriage, place the upper pivot in the pivot bolt, using a light, clean grease, if necessary, to secure sufficient suction to hold it up. Spring the upper end of the elastic suspension housing cover into the grooves of the pivot bolt.

b. Having cleaned and lubricated all parts, put the lower pivot assembly, with the Belleville springs, lower pivot nut down, in the

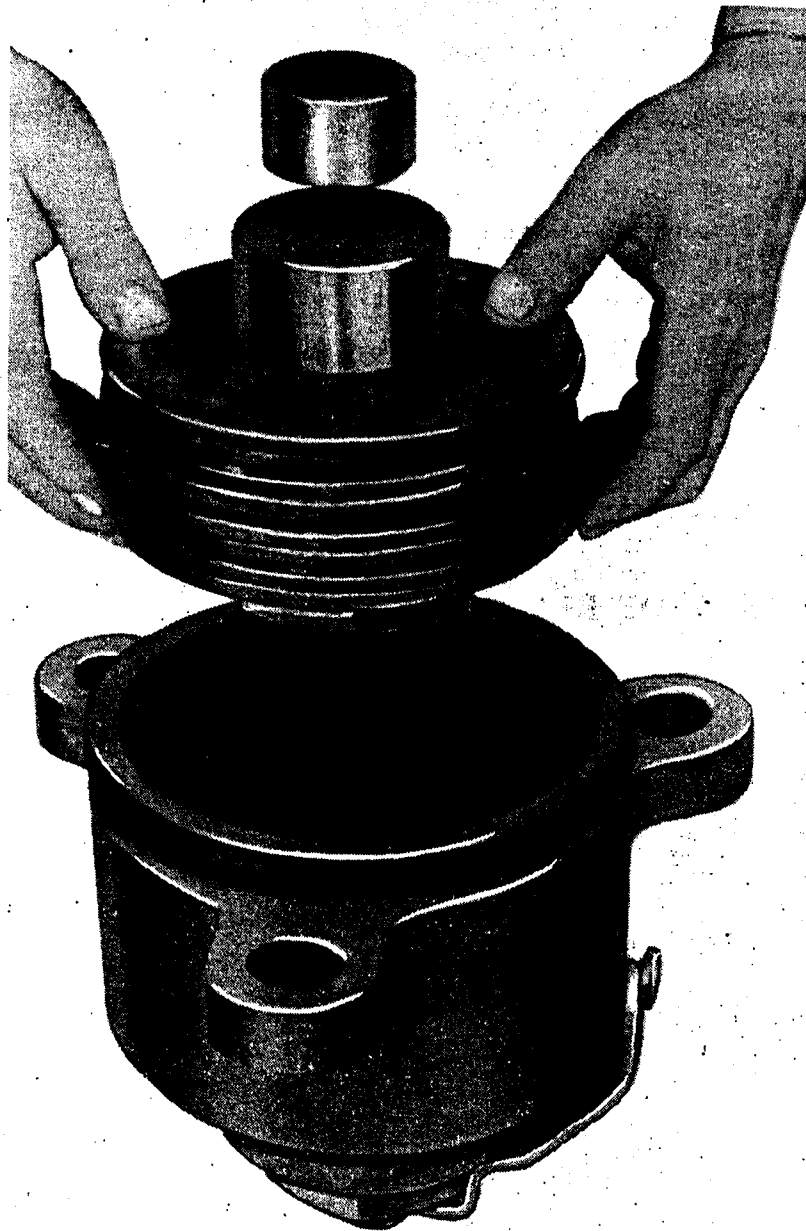

RA PD 37702

Figure 126—Placing the lower pivot assembly in the housing

## DISASSEMBLY AND ASSEMBLY

housing, and place the step on the lower pivot (fig. 126). Pack the housing full of clean lubricating graphite grease. Raise the housing into place, guiding it onto the elastic suspension housing bolts, screw on the three elastic suspension housing bolt nuts, and assemble the cotter pins.

c. Screw in the spring suspension adjusting nut (fig. 95), and raise the top carriage just enough to traverse the carriage with very little effort applied to the traversing handwheel. Check the clearance between the bottom and top carriages (fig. 96). This clearance must not exceed 0.012 inch. Secure the adjusting nut locking strap.

d. Spring the elastic suspension housing cover down over the head of the elastic suspension housing.

## 89. DISASSEMBLY AND ASSEMBLY OF WHEELS

a. 155-mm gun carriages, M2 and M3, and heavy carriage limber, M3. (1) To remove the tire and wheel assembly. Jack up the wheel until it clears the ground. Remove the ten retaining nuts. Tip out the top of the assembly to allow the wheel to clear the hub. The retaining nuts for the left wheel have left-hand threads.

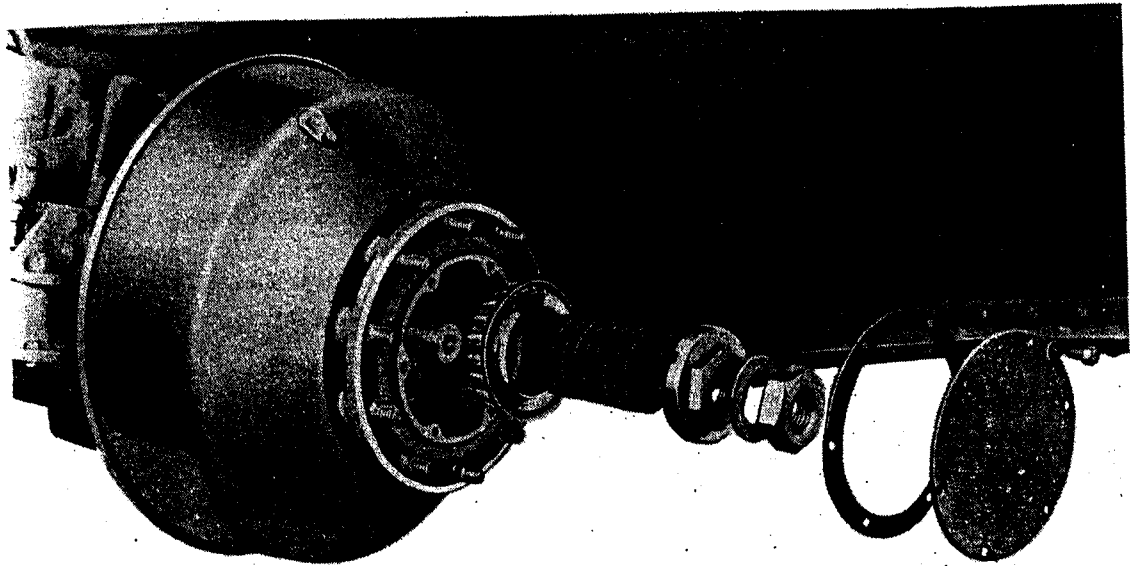

RA PD 37475

*Figure 127—Exploded view of carriage, M2, wheel hub*

(2) To remove the carriage hub assembly. Remove the hub cap and gasket. Straighten the bent internal lug of the axle end nut lock washer to release the axle end nut, and remove both. Remove axle bearing adjusting nut and bearing adjusting shims. Pull the hub assembly off the axle, being careful not to let the outer roller bearing drop out of place. Remove the outer roller bearing by hand as the hub is being dismantled (fig. 127).

## 155-MM GUN MATERIEL, M1917, M1918 AND MODIFICATIONS

(3) To remove the limber hub assembly. Remove the hub cap and gasket. Remove the axle end nut and nut dowel washer. Remove the bearing adjusting nut and dowel. Pull the hub assembly off the axle end, being careful not to let the outer roller bearing drop out of place. Remove the outer roller bearing by hand as the hub is being dismantled (fig. 128).

(4) To remove the inner bearing and oil retainer from carriage or limber hub. Pull, or drive out with hammer and brass drift, the inner bearing and leather hub oil seal (carriage), or oil retainer (limber), from the hub. If the inner bearing must be driven out, drive carefully against the bearing cone, and force it out evenly by tapping all around the edges.

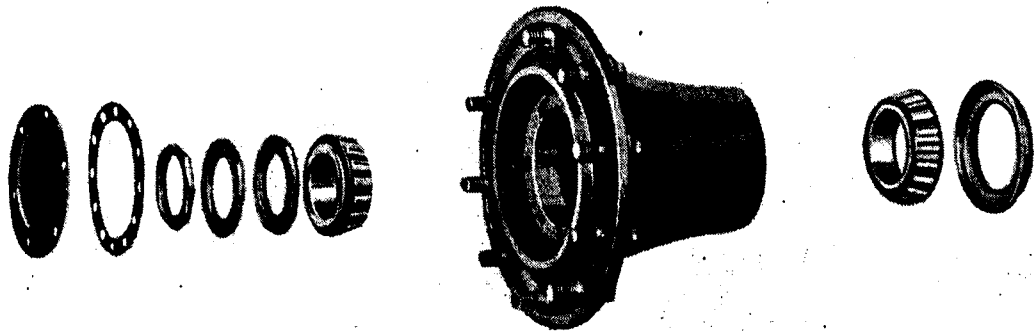

RA PD 37707

*Figure 128—Exploded view of limber, M3, wheel hub*

(5) To assemble the hub. Install the inner bearing in position in the inner bearing cup. In a carriage wheel, install the leather hub oil seal, after making certain that the leather is soft, pliable and in good condition, and that the axle end surface is smooth. New seals should be soaked for 30 minutes in warm (not hot) engine oil. In a limber wheel, install the oil retainer, forcing it in position with a brass drift. Tap it evenly, so as not to bend it, or to get it out of line. Make sure the retainer is correctly in position.

(6) Slide the hub assembly on the axle end, keeping it straight with the axle to prevent damage to the oil seal or retainer. Work it back and forth with short strokes to tap the bearing and seal or retainer into position. Install the outer bearing. Complete the assembly of carriage hubs and adjust the bearings as prescribed in paragraph 54 e. Complete the assembly of limber hubs and adjust the bearings as prescribed in paragraph 54 f.

(7) To install the tire and wheel assembly. With axle raised high

## DISASSEMBLY AND ASSEMBLY

enough for the tire to turn, install the tire and wheel assembly. Install the ten disk and rim wheel stud nuts and lock washers, and tighten them firmly. Nuts for right wheels have right hand threads; nuts for left wheels have left hand threads.

b. Carriages and limbers, M1917A1 and M1918A1.

(1) To disassemble, raise the wheels clear of the ground. Remove the hub cap and hub cap gasket. Remove the outer bearing jam nut, outer bearing adjusting jam nut lock washer, bearing adjusting nut washer, and the bearing adjusting nut assembly. Slide the wheel from the axle, taking care that the outer axle roller bearing does not fall to the ground. Remove the cap screws from the roller bearing retaining ring and remove the oil seal. Remove the axle inner roller bearing.

(2) To assemble, pack the axle inner roller bearing with wheel bearing grease and assemble it within its housing. Cover both sides of the roller bearing retaining ring gasket with gasket cement and place it against the face of the roller bearing retaining ring. Assemble the roller bearing retaining ring and tighten each cap screw alternately until the roller bearing retaining ring has an even bearing. Cover the metal of the oil seal with gasket cement and place it within the recess of the roller bearing retaining ring.

(3) Assemble the wheel over the axle, taking care not to damage the oil seal as it passes over the axle spacing collar. Hand pack the outer axle roller bearing and place it within its housing. Assemble the bearing adjusting nut with just enough tension to allow the wheel to revolve freely without end play. Assemble the bearing adjusting nut washer, outer bearing, jam nut lockwasher, and the outer bearing jam nut. Place the hub cap gasket in position and assemble the hub cap.

c. Carriages and limbers, M1917 and M1918.

(1) Remove the brake band assembly (if a carriage wheel). Lift wheel clear of the ground. Remove the hub cap, cotter pin, and wheel fastening nut lock collar, and slide the wheel off. Weight of wheel and brake parts is about 1020 pounds. Take off the fiber journal gasket for examination. Retain all of the nuts and cotter pins for assembling.

(2) Clean all of the parts of the hub and axle spindle and examine for scoring. Smooth off all roughness. Pay particular attention to cleaning the passage for lubricant in the lock collar and lock nut. Special attention should be given to the under side of the axle spindle.

(3) When the hub liner and axle spindle are clean and smooth, put on the journal gasket, grease the axle spindle, and slip the wheel in place. Follow with the lock collar, wheel fastening nut, cotter pin and hub cap, in the order named, and connect the brake band.

DIFICATIONS

e the hub cap  
asher. Remove  
sembly off the  
g drop out of  
hub is being

from carriage  
rift, the inner  
ner (limber),  
ive carefully  
g all around

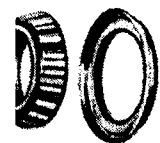

D 37707

position  
ther hub  
e and in  
few seals  
oil. In a  
a brass  
e. Make

straight  
Work it  
retainer  
of car-  
54 e.  
as pre-

d high

90. TO REMOVE PNEUMATIC TIRE AND TUBE

a. The wheel rims used on the heavy carriage limber, M3, are of a different type than those used on the 155-mm gun carriages, M2 and M3. The difference is in the method of retaining the tire on the wheel. The limber wheels have a single removable tire locking ring (rim flange) while the wheels of the carriage have not only a removable rim flange but also a removable flange locking ring.

b. Remove wheel and tire assembly. [See par. 89 a. (1).]

c. Remove tire locking ring (rim flange), limber wheels. Deflate tire and tube by removing tube valve core. Using two pry bars,

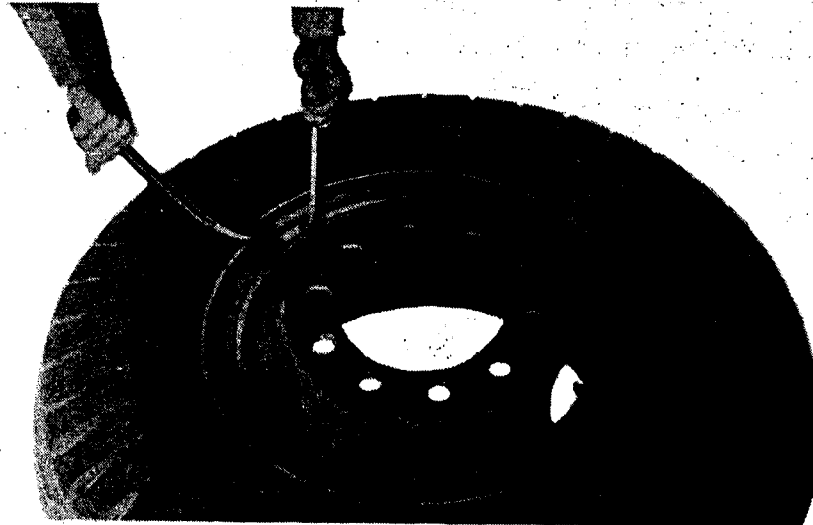

RA PD 37480

*Figure 129—Removing limber wheel tire locking ring*

pry the two ends of the locking ring apart, and at the same time, pry the slotted end of the ring out of the rim well (fig. 129). With the slotted



RA PD 37481

*Figure 130—Removing carriage wheel tire locking ring*

### DISASSEMBLY AND ASSEMBLY

end of the ring free of the rim, continue to pry or pull the rest of the ring out of the rim well, being careful not to bend or spring the ring out of round.

d. Remove locking ring and rim flange, carriage wheels. Deflate tire and tube. Using two pry bars, pry down on the rim flange to release the locking ring, and at the same time, pry the slotted end of the locking ring out of the rim well (fig. 130). With the slotted end of the locking ring free of the rim, continue to pry or pull the rest of the ring out of the rim well, being careful not to bend or spring the ring out of round. Remove the rim flange by lifting it off the rim.

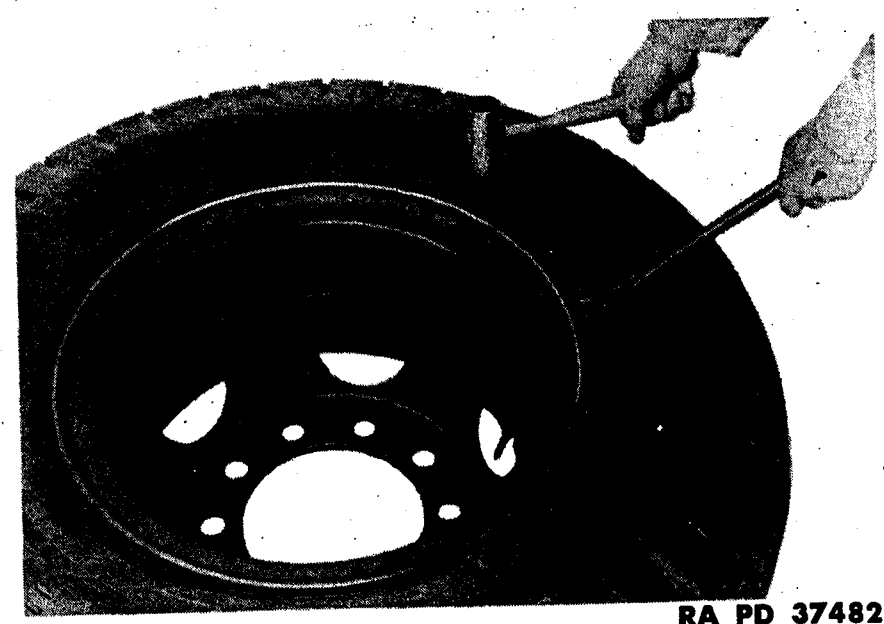

RA PD 37482

Figure 131—Loosening tire from wheel rim flange

e. Dismount tire and tube. Turn the wheel and tire assembly over and block up under the wheel. Pry the tire bead loose from the wheel, using a pry bar and hammer, if necessary (fig. 131). Force the tire down off the wheel. Remove the wheel assembly.

f. Remove tube. Remove the tube inner liner or flap. Spread the tire beads apart, using a large size tire spreader or suitable wood blocks. Work the tube out of the tire casing. This is rather difficult because of the size and thickness of the tube. When removing the tube, make sure it is completely deflated.

### 91. TO INSTALL PNEUMATIC TIRE AND TUBE

a. Before installing a tube in a tire, make sure all dirt is removed from the tire. Both the tire and tube should be thoroughly dry. A small amount of tire talc applied to the inside of the tire is recommended.

ATIONS  
M3, are of  
pages, M2  
re on the  
king ring  
removable

(1.)  
wheels.  
pry bars,

pry  
tted

## 155-MM GUN MATERIEL, M1917, M1918 AND MODIFICATIONS

b. Install tube. Spread the tire beads apart. Work the tube into position in the casing. Make sure the tube is completely deflated before attempting to install it. Install the tube with the valve stem opposite the balancing mark on the tire. Install the liner or flap (fig. 132), working the edges under the tire beads.

c. Mount tire and tube assembly on wheel rim. Block up the wheel so that the tire, when installed, will just clear the floor or ground. The flanged side of the wheel rim should be at the bottom. Mount the tire and tube assembly on the rim, forcing it all the way into

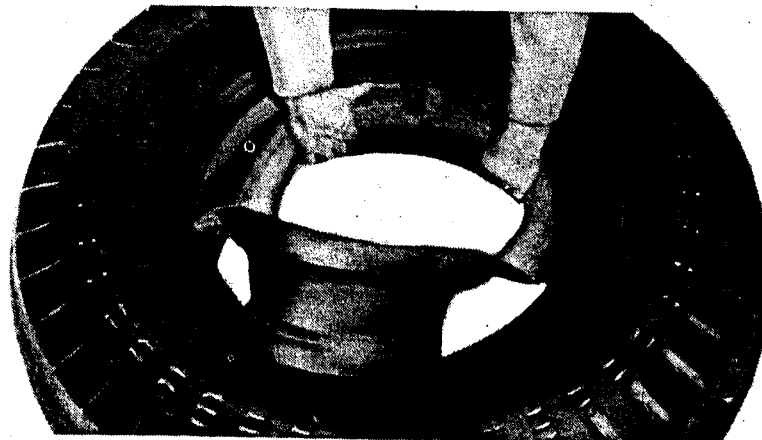

RA PD 37483

*Figure 132—Installing the tire flap*

position. The valve stem should enter the slot in the rim and point outward toward the removable rim flange or tire locking ring side of the wheel.

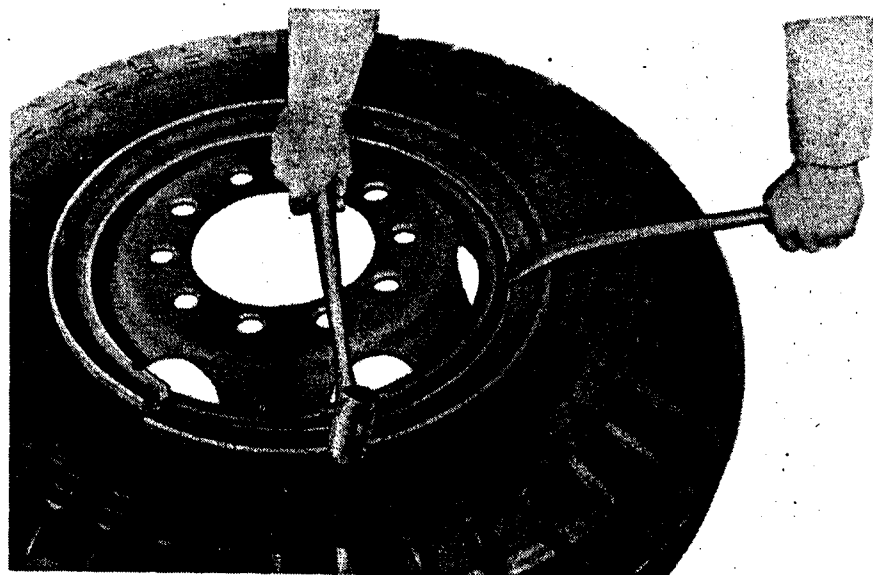

RA PD 37485

*Figure 133—Starting tire locking ring on limber wheel*



**DISASSEMBLY AND ASSEMBLY**

d. Install tire locking ring (rim flange), limber wheels. Insert the plain end of the ring (end opposite slotted end) in the rim well. Pry down on the ring about one-third of the distance around the ring from the plain end. At the same time, hammer more of the ring into the rim well (fig. 133). Spread the tire locking ring by prying the two ends apart, and while doing this, hammer the ring into the rim well throughout its entire length. Make sure the ring is securely seated in the rim well before inflating the tire.

e. Install rim flange and locking ring, carriage wheels. Install the removable rim flange in position on the wheel. Start the locking

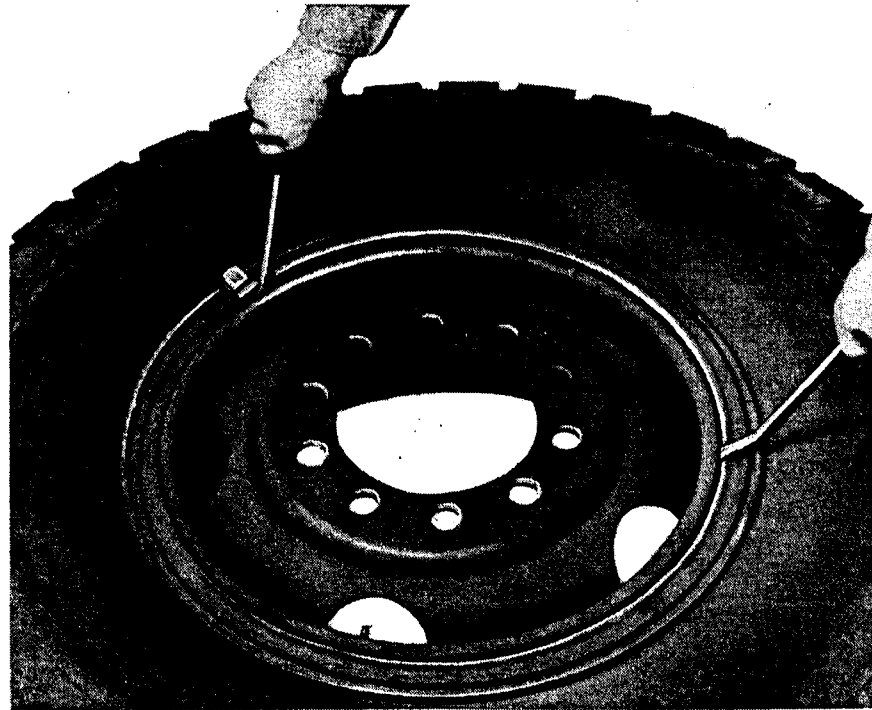

RA PD 37487

*Figure 134—Installing tire flange locking ring on carriage wheel*

ring, lug-end first, into the rim well. Spread the locking rim by prying the two ends apart, and at the same time, pry the rest of the locking ring down into position in the rim well (fig. 134). Make sure the locking ring is securely seated in the rim well before attempting to inflate the tire.

f. Inflate tire. Inflate to the recommended pressure: limber tires, 70 pounds; carriage tires, 90 pounds.

**CAUTION:** Tap the locking ring during the initial inflation to seat it firmly in the rim well. Stand aside while inflating the tire to avoid personal injury in case the locking ring is not properly seated in the rim well and flies off the wheel.

g. Install wheel and tire assembly.

**Section XI**  
**SIGHTING EQUIPMENT**

	<b>Paragraph</b>
General.....	92
Care and Preservation.....	93
Quadrant Sight, M1918; Panoramic telescope, M6.....	94
Aiming post, M1.....	95
Aiming post light, M14.....	96
Gunner's quadrant, M1.....	97
Gunner's quadrant, M1918.....	98
Bore sight.....	99
Testing target.....	100

**92. GENERAL**

The equipment required for sighting and alining the sighting equipment of the 155-mm guns, M1917, M1917A1 and M1918MI, is:

- a. The quadrant sight, M1918, (or the quadrant sight, M1918A1) and the panoramic telescope, M6, for aiming the gun in direction, and for aiming or laying the gun in elevation. The accessories required for this item of equipment are the cover for the protection of the instrument, the 14-inch extension used to raise the panoramic telescope when required for sighting over a shield, the instrument light, M9, for illuminating the instrument, and wrenches for necessary adjustment.
- b. Two aiming posts, M1, placed in a direct line to provide a vertical line aiming point to detect any lateral displacement of the piece during firing.
- c. Two aiming post lights, M14, for indicating the aiming posts for night firing.
- d. The gunner's quadrant, M1, (or the gunner's quadrant, M1918) for measuring the elevation of the piece, and laying the piece to a given elevation.
- e. The bore sight used to aline the sights with the bore of the gun.
- f. The testing target used during the bore sighting operation.

**93. CARE AND PRESERVATION**

- a. General. (1) The instructions given here supplement the

### SIGHTING EQUIPMENT

instructions pertaining to individual items of sighting and fire control equipment described in this and the following section.

(2) Fire-control and sighting instruments are, in general, rugged and suited for the purpose for which they have been designed. They will not, however, stand rough handling or abuse. Inaccuracy or malfunctioning will result from mistreatment.

(3) Disassembly and assembly by the using arm is permitted only to the extent authorized for each of the individual instruments. Unnecessary turning of screws, or other parts not incident to the use of the instrument, is expressly forbidden.

(4) Keep the instruments as dry as possible. If the instrument is wet, dry it carefully before placing it into its carrying case.

(5) When not in use, keep the instruments in the carrying cases provided, or in the condition indicated for traveling.

(6) Any instruments which indicate incorrectly, or fail to function properly, after the authorized tests and adjustments have been made, are to be turned in for repair to ordnance personnel. Adjustments other than those expressly authorized for each of the individual instruments, are not to be performed by the using arm.

(7) No painting of fire-control equipment by the using arm is permitted.

(8) Many worm drives have throwout mechanisms to permit rapid motion through large angles. When using these mechanisms, it is essential that the throwout lever be fully depressed to prevent injury to the worm and gear teeth.

(9) When using a tripod with adjustable legs, be certain that the legs are clamped tightly to prevent possibility of collapse.

(10) When setting up tripods on sloping terrain, place two legs on the downhill side to provide maximum stability.

b. **Leather Articles.** Care and preservation of leather articles are covered in paragraph 58 j.

c. **Optical Parts.** (1) To obtain satisfactory vision, it is necessary that the exposed surfaces of the lenses and other parts be kept clean and dry. Corrosion and etching of the surface of the glass, which greatly interfere with the good optical qualities of the instrument, can be prevented, or greatly retarded, by keeping the glass clean and dry.

(2) Under no condition will polishing liquids, pastes, or abrasives be used for polishing lenses and windows.

(3) For wiping optical parts, use only lens paper specially intended

Paragraph  
92  
93  
94  
95  
96  
97  
98  
99  
100  
g equip-  
918A1)  
n, and  
red for  
ment,  
en re-  
illumi-  
ide a  
f the  
posts  
918)  
iven  
un.  
re

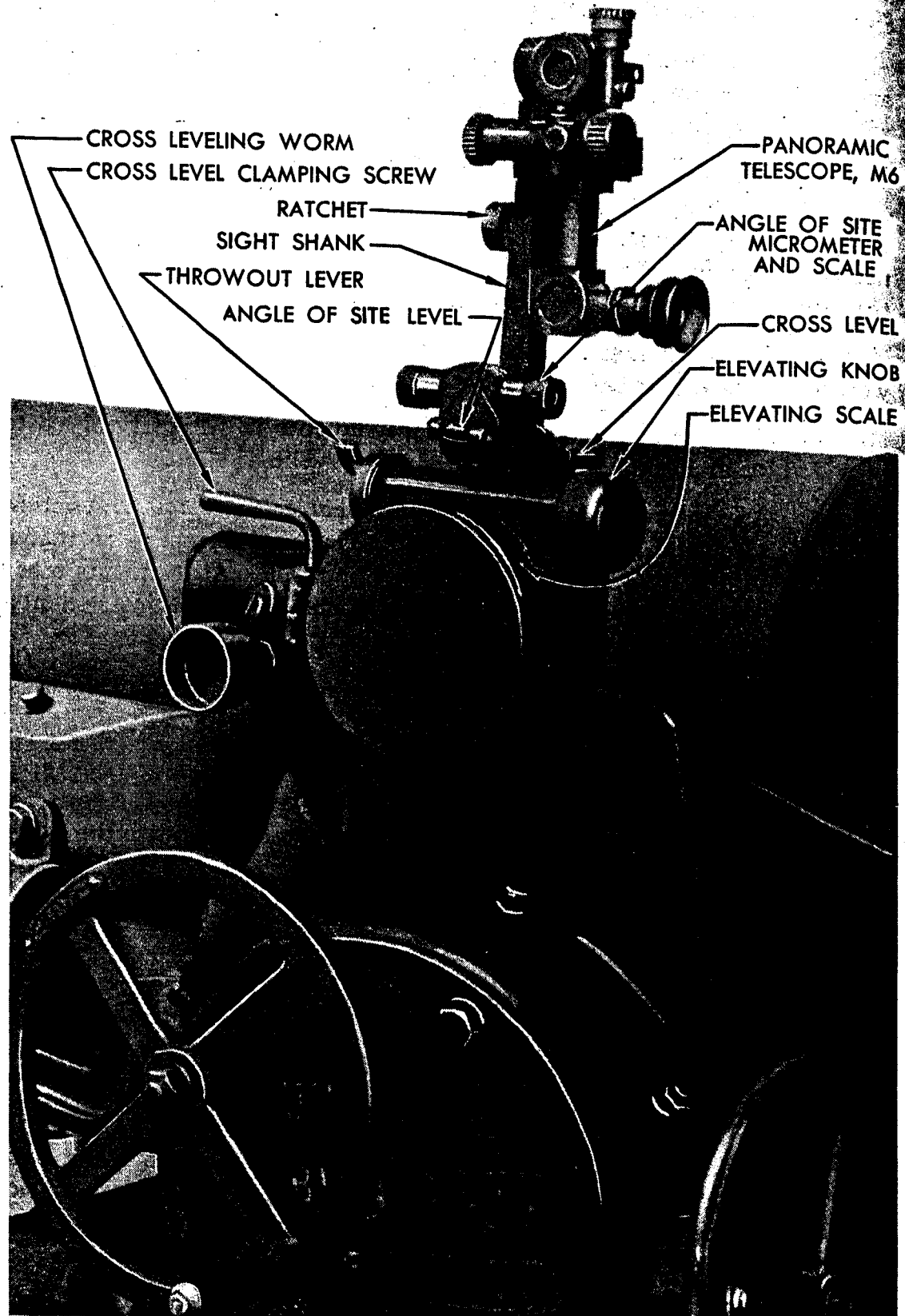

RA PD 37659

Figure 135—The quadrant sight, M1918, with panoramic telescope, M6, mounted on the 155-mm gun carriage, M2

for c  
mitte  
hair  
the s  
until  
with  
esse:

and  
rem  
clea  
is r  
len:

of  
of  
by  
ce:  
ex  
in

lu

t

g

s

**SIGHTING EQUIPMENT**

for cleaning optical glass. Use of cleaning cloths in the field is not permitted. To remove dust, brush the glass lightly with a clean camel's-hair brush and rap the brush against a hard body in order to knock out the small particles of dust that cling to the hairs. Repeat this operation until all dust is removed. With some instruments, an additional brush with coarse bristles is provided for cleaning mechanical parts; it is essential that each brush be used only for the purpose intended.

(4) Exercise particular care to keep optical parts free from oil and grease. Do not wipe the lenses or windows with the fingers. To remove oil or grease from optical surfaces, apply ethyl alcohol with a clean camel's-hair brush and rub gently with clean lens paper. If alcohol is not available, breathe heavily on the glass and wipe off with clean lens paper; repeat this operation several times until clean.

(5) Moisture due to condensation may collect on the optical parts of the instrument when the temperature of the parts is lower than that of the surrounding air. This moisture, if not excessive, can be removed by placing the instrument in a warm place. Heat from strongly concentrated sources should not be applied directly, as it may cause unequal expansion of parts, thereby resulting in damage of optical parts and inaccuracies of observation.

d. Lubricants. (1) Where lubrication with oil is indicated, use lubricating oil for aircraft instruments and machine guns.

(2) Where lubrication with grease is indicated, use special, low temperature grease.

**94. QUADRANT SIGHT, M1918; PANORAMIC TELESCOPE, M6**

a. General. The quadrant sight M1918 (fig. 135) or quadrant sight M1918A1, is used with the panoramic telescope M6 for aiming the gun in direction, and for aiming or laying the gun in elevation. The quadrant sight and panoramic telescope M6 form the authorized sighting combination for use by Field Artillery.

b. The Quadrant Sight, M1918A1. The quadrant sight, M1918A1, incorporates an alternative construction of the angle of site level, but is in all other respects the same as the M1918. Operation procedure is the same with either model.

c. Description of Quadrant Sight, M1918. (1) The quadrant sight, M1918, is mounted on the left trunnion of the cradle. Three screws and a dowel pin secure the sight to the trunnion.

(2) The three principal parts of the quadrant sight are the cross level mechanism, elevation mechanism and angle of site mechanism. The

DIFICATIONS

—PANORAMIC TELESCOPE, M6

ANGLE OF SITE MICROMETER AND SCALE

—CROSS LEVEL

ADJUSTING KNOB

ADJUSTING SCALE

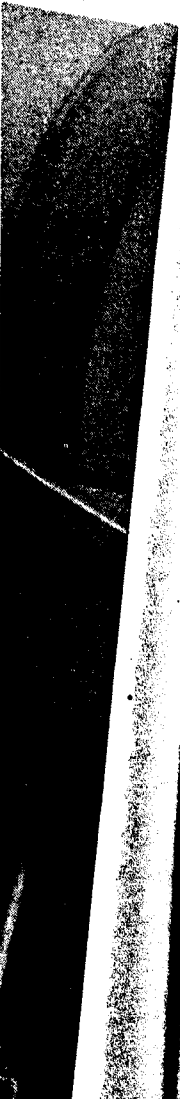

7659

## 155-MM GUN MATERIEL, M1917, M1918 AND MODIFICATIONS

sight shank is designed to receive the panoramic telescope. The quadrant sight with panoramic telescope mounted is shown in fig. 135.

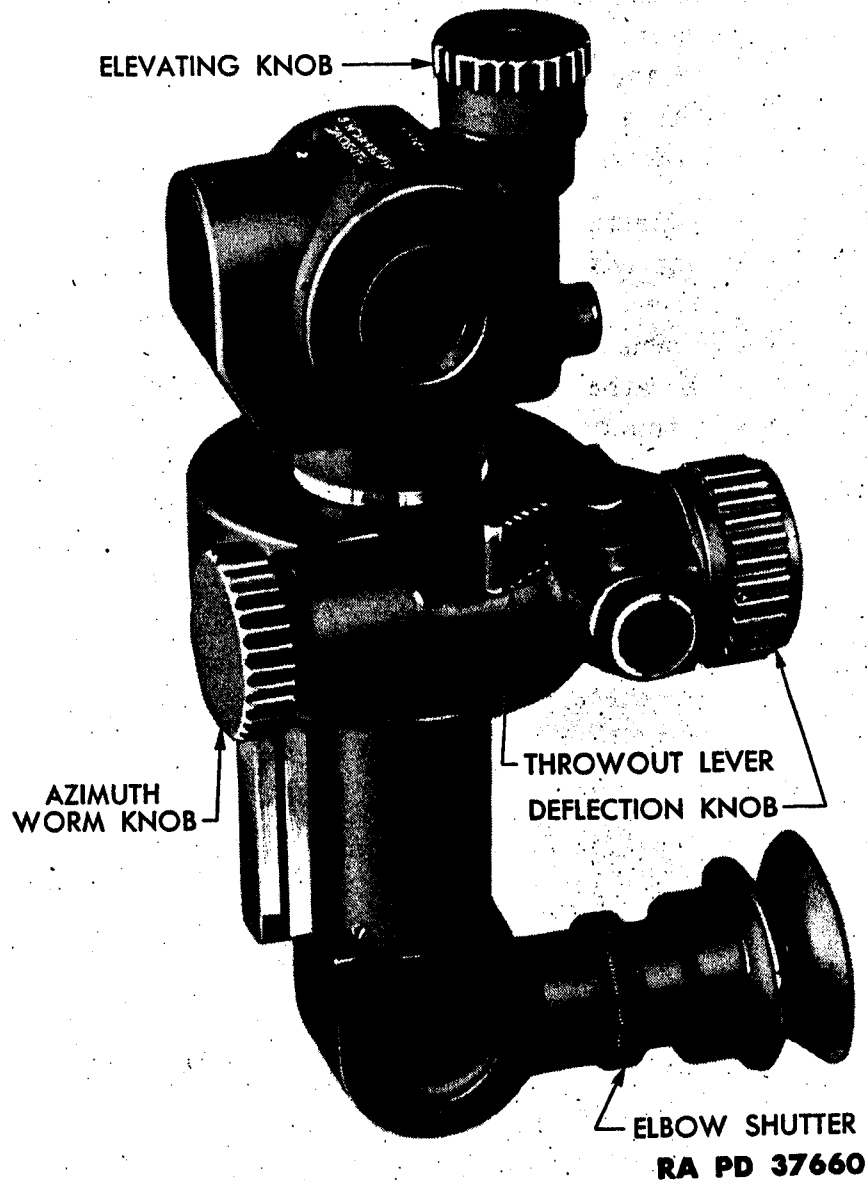

Figure 136—Left side view of the panoramic telescope, M6

(3) Rotation of the cross leveling worm causes tilting of the sight body, which movement is indicated by the bubble of the cross level. The cross level clamping screw clamps the sight body to prevent disturbance of the cross level position during firing. When the cross level bubble is centered, the sight is in the true vertical plane.

(4) The angle of site and elevation mechanisms introduce and add together their respective elements of data. The elevation scale is graduated in mils and contains two rows of graduations. The outer row reads elevation from 0 to 800 mils ( $0^{\circ}$  to  $45^{\circ}$ ); the inner row forms a continuation of the outer row and reads from 800 to 1160 mils ( $45^{\circ}$  to  $65^{\circ}$ ). Rapid movement in elevation is accomplished by rotating and holding

### SIGHTING EQUIPMENT

the throwout lever so that the sight shank can be raised or lowered with the hand.

(5) The angle of site level establishes a horizontal datum plane. The gun is laid in elevation by centering the bubble of this level. The angle of site scale is graduated at 100 mil intervals, numbered from 0 to 6, and the angle of site micrometer is graduated at 1-mil intervals numbered from 0 to 100. The angle of site setting is the sum of values indicated on the scale and micrometer. The 300-mil setting is the normal setting corresponding to zero angle of site.

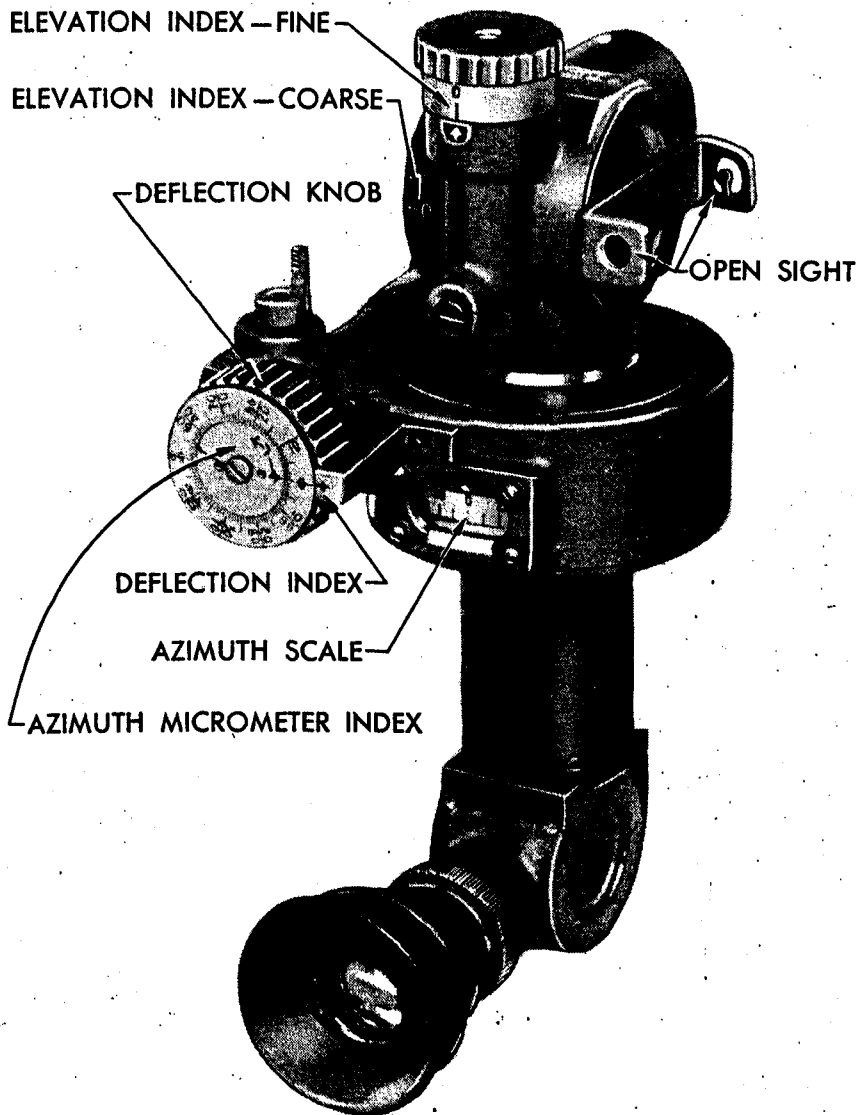

RA PD 37661

Figure 137—Rear right view of the panoramic telescope, M6

d. Description of Panoramic Telescope, M6. (1) The panoramic telescope is attached to an upright arm of the quadrant sight. The sight shank has a T-shaped slot milled at its upper end to receive the T-shaped lug of the panoramic telescope. The panoramic telescope is held rigid in the slot by a clamp.

MODIFICATIONS

e. The quadrant  
g. 135.



TER  
60  
6

the sight  
cross level.  
event dis-  
cross level

and add  
is grad-  
ow reads  
continu-  
to 65°).  
holding

## 155-MM GUN MATERIEL, M1917, M1918 AND MODIFICATIONS

(2) The panoramic telescope, M6 (figs. 136 and 137) is a four-power fixed-focus telescope with a rotating head and azimuth mechanism by which the line of sight may be directed to any desired azimuth. A movable prism permits the line of sight to be elevated or depressed through a limited angle, as required to keep the aiming point within the field of view. The reticle contains a vertical and a horizontal cross line and a horizontal mil scale.

(3) The line of sight is elevated or depressed by means of the knob at the top, and coarse and fine index graduations are provided for the normal (zero elevation) position. There is no provision for reading other angles of elevation.

(4) The azimuth scale is graduated at 100-mil intervals, numbered progressively from 0 to 32 in two consecutive semicircles. Zero readings indicate the line of sight to be directly forward or directly backward. The telescope is moved in azimuth by means of the azimuth worm knob, which has a throwout lever to permit disengagement for rapid motion when required. Indications of the azimuth micrometer index on the deflection knob, which is graduated at 1-mil intervals, supplement those on the azimuth scale.

(5) The deflection knob is assembled to a detent which causes a click at each 1-mil interval as the deflection knob is rotated. Rotation of the deflection knob does not affect the actual value of deflection previously set, but changes the indicated value thereof.

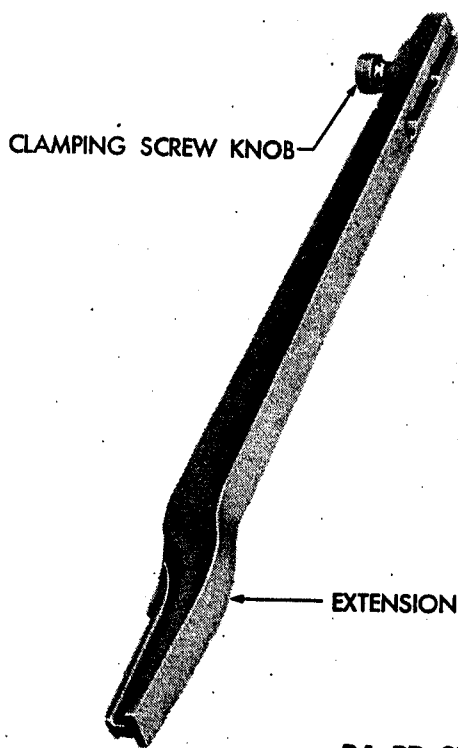

RA PD 37662

Figure 138—Fourteen-inch extension for panoramic telescope

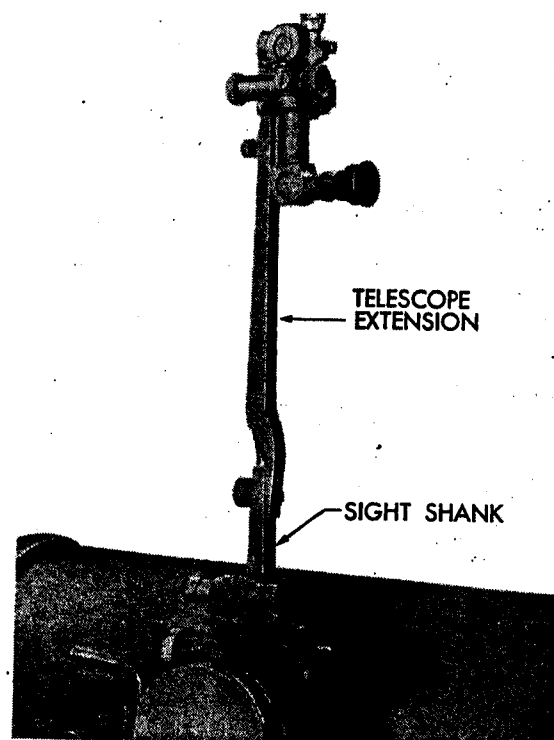

RA PD 37663

Figure 139—Panoramic telescope extension in position



## SIGHTING EQUIPMENT

e. Description of 14-inch panoramic telescope extension. The panoramic telescope extension (fig. 138) is used to raise the panoramic telescope when required for sighting over the shield. The lower end of the extension is formed with a T-lug which fits into the sight shank of the quadrant sight. The upper end is formed with a corresponding slot which receives the panoramic telescope. The extension must be removed from the quadrant sight before the gun is fired or before traveling.

f. Operation. (1) Preliminary operating procedure. This procedure is the same for either direct or indirect aiming.

(a) Remove the panoramic telescope from its case and mount it in the T-slot of the quadrant sight. Clamp by means of the ratchet, pressing on the detent alongside to release the ratchet. Uncover the levels.

(b) Keep the quadrant sight continuously cross-leveled (cross level bubble centralized) by means of the cross leveling worm. The cross leveling worm must not be operated until the clamping screw has been released. The clamping screw should normally be kept tightened to prevent disturbance of the cross level position and to remove strain from the cross leveling worm.

(c) Use the telescope extension when vision is obscured by the shield or other carriage part. The accuracy of the sight is reduced when using the extension and hence its use should be limited when possible. Remove the extension from the quadrant sight before firing the piece and before traveling.

(d) For operation in darkness, a window located under the elbow shutter of the panoramic telescope permits illumination of the reticle cross lines, using instrument light, M9.

(2) Direct aiming. (a) Rotate the elevating knob of the quadrant sight until the elevation in mils corresponding to the target range is indicated on the elevation scale. Use the throwout lever for rapid setting when necessary to accomplish large movements of the elevation scale.

(b) Set the rotating head of the panoramic telescope to the normal or zero elevation position by means of the elevating knob. In this setting, the coarse and fine elevation indexes coincide with their respective zero lines.

(c) By means of the azimuth worm knob of the panoramic telescope, set the azimuth scale and micrometer to indicate zero. Deflection corrections, where required, are inserted before making the above setting by turning the deflection knob of the panoramic telescope.

**155-MM GUN MATERIEL, M1917, M1918 AND MODIFICATIONS**

(d) Elevate and traverse the carriage until the reticle cross lines fall on the target. Use the open sight on the side of the rotating head (fig. 137) to secure approximate direction.

(e) When it is desired to lay the gun in elevation, set the quadrant sight elevation scale to correspond to the target range, as before, and set the angle of site scale and micrometer to the announced setting, corresponding to the angle of site to the target. Elevate the carriage until the angle of site level bubble is centralized, and traverse until the target appears on the vertical cross line of the reticle. Should the target not appear near the center of the field when using this method, the elevating knob at the top of the telescope may be turned to raise or lower the line of sight. This, however, cannot be done when using the previously described method of aiming in elevation.

(3) Indirect aiming. (a) Rotate the elevating knob of the quadrant sight until the elevation in mils, corresponding to the target range, is indicated on the elevation scale. Use the throwout lever for rapid setting when necessary to accomplish large movements of the elevation scale.

(b) Set the angle of site scale and micrometer to the announced setting corresponding to the angle of site to the target.

(c) In this type of fire, direction is obtained by aiming on an aiming post or sighting point other than the target. By means of the azimuth worm knob, set the azimuth scale and azimuth micrometer index to indicate the firing angle. (Firing angle is the horizontal clockwise angle measured from the target to the aiming point, whose apex is at the piece.) Arbitrary corrections are applied before setting azimuth by setting the deflection knob against the correction index to indicate the correction angle. If desired, the correction angle can be included with the firing angle, in which case the deflection knob is set to zero. Use the throwout lever for rapid setting when necessary to accomplish large movements of the azimuth scale.

(d) Elevate the carriage until the angle of site level bubble is centralized, and traverse until the target appears on the vertical cross line of the reticle. Should the target not appear near the center of the field, the elevating knob at the top of the telescope may be turned to raise or lower the line of sight. Use the open sight for approximate aiming. Note that when the angle of site is not set at normal, azimuths or firing angles are measured in the plane of site rather than the horizontal plane; this applies when both orienting and sighting.

## SIGHTING EQUIPMENT

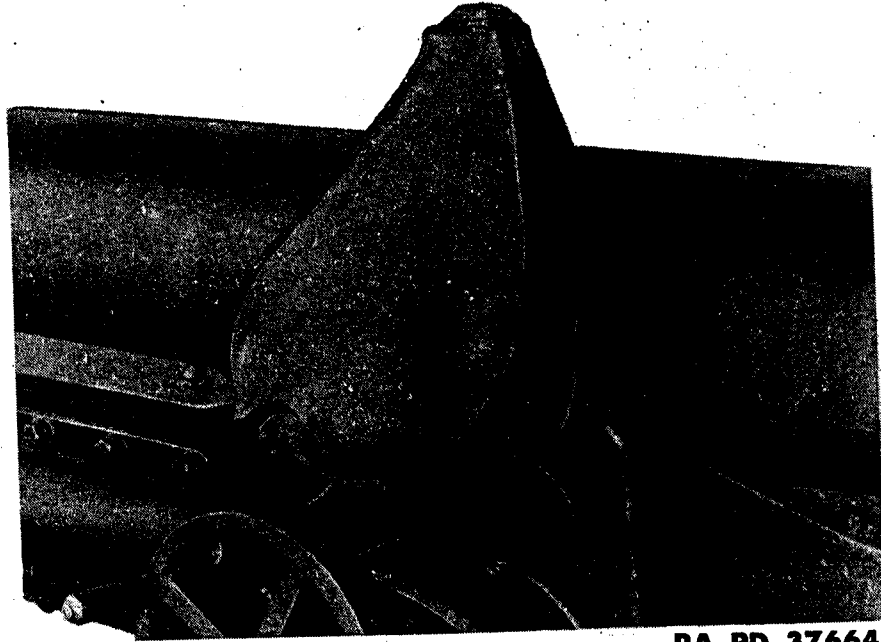

RA PD 37664

Figure 140—Cover for the quadrant sight, M1918, in position

(4) Preparing the sight for traveling. Remove the panoramic telescope and place it in the case provided. Lower the sight shank until the elevation scale reads approximately zero, cover the levels, and tighten the leveling worm clamping screw so as to remove the strain from the cross leveling worm. Place the cover over the quadrant sight (fig. 140).

g. Tests and adjustments. Only the adjustments specifically authorized may be performed by the using arm.

(1) Verification and adjustment of angle of site level. Level the carriage, transversely (axis of trunnions), and longitudinally (axis of bore). Cross-level the quadrant sight. With elevation set at zero and angle of site set at normal (300), the angle of site level bubble should be centered with respect to the graduations on its vial. If the bubble is not centered, rotate the angle of site knob until the vial is level. For quadrant sight, M1918, loosen the headless set screw which holds the micrometer knob in place, and loosen the plug at the center of the micrometer knob, using the triangular head quadrant sight socket wrench provided. For the M1918A1, use a screwdriver to loosen the micrometer nut in the center of the micrometer knob. Then, for either sight, proceed to slip the micrometer, without turning the worm, until the index on the worm housing points to zero. Tighten the plug and set screw or nut.

(2) Verification and adjustment of cross level. With the gun at zero elevation, direct the panoramic telescope on a distant target and then elevate the gun to maximum elevation, at the same time elevate

**155-MM GUN MATERIEL, M1917, M1918 AND MODIFICATIONS**

the quadrant sight to keep the panoramic telescope on the target. If the point where the line of sight pierces that target appears to move either to the right or left, it indicates that the cross level of the quadrant sight is out of adjustment. Find, by trial, a cross level worm position in which the carriage can be elevated or depressed to the full extent of its travel with no apparent deviation of the line of sight. Using the triangular head quadrant sight socket wrench provided, loosen the clamping screw directly above the cross level holder and carefully move the cross level holder until the bubble in the level vial is centered between the reference marks, and tighten the set screw.

(3) **Bore sighting.** With the carriage level, as above, place the testing target in a plane perpendicular to the bore of the gun and at a distance of about 50 yards. Place the bore sights in the gun and move the testing target until the center line of the bore, as determined by the bore sights, pierces the lower circle of the target. The placement of the target in the vertical plane should be verified by a plumb line. Set the quadrant sight elevation at zero. The circle corresponding to the line of sight of the panoramic telescope should appear exactly at the intersection of the cross lines on the reticle.

(a) Failure to coincide vertically indicates that the elevating knob of the panoramic telescope is out of adjustment. Rotate the knob until the line of sight pierces the target on the horizontal center line. Loosen the locking screw at the center of the elevating knob and slip the knob until the zero is in line with the index, then tighten the locking screw. Some panoramic telescopes have three screws, all of which must be loosened to permit adjustment. Do not lift the knob during the adjustment, as such action may cause the stop rings within the knob to become disarranged.

(b) Failure to coincide laterally indicates that the azimuth micrometer is out of adjustment. Rotate the azimuth worm knob until the line of sight pierces the corresponding target on the vertical center line. Rotate the azimuth worm knob until the line of sight pierces the target on the vertical center line. Loosen the locking screw at the center of the micrometer index and slip the index until the arrow is in line with the zero of the deflection knob (set to zero against the deflection index), then tighten the locking screw. If the azimuth scale and micrometer index do not both indicate zero simultaneously, or if the coarse and fine elevation indexes do not indicate simultaneously, the matter should be brought to the attention of qualified ordnance personnel.

**h. Tools.** The following tools are issued with the quadrant sight:

(1) Wrench, quadrant sight socket. The quadrant sight socket

**SIGHTING EQUIPMENT**

wrench is double-head wrench with 6.3-mm and 9.3-mm triangular openings. The wrench is used in adjusting the quadrant sight, but is not used for other than authorized operations.

(2) Wrench, wing teat, pin face,  $\frac{3}{8}$ -inch span, with screwdriver blade (fig. 180). Used in adjusting the panoramic telescope, but not to be used for other than authorized operations.

i. Care and preservation. (1) Refer to paragraph 93, for general instructions pertaining to the care and preservation of instruments.

(2) Keep the T-lugs and T-slots clean and lightly greased. Be careful to avoid denting or burring.

(3) Do not attempt to force the rotation of any of the knobs beyond their limits.

**95. AIMING POST, M1**

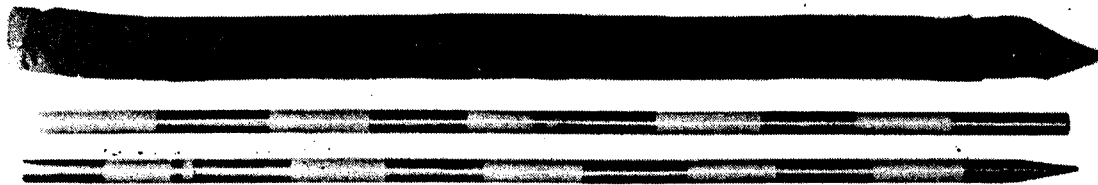

RA PD 37665

*Figure 141—Aiming post, M1 (two sections), and case*

Two of these aiming posts are furnished with each 155-mm gun, M1917, M1917A1, and M1918. Each aiming post (fig. 141) consists of two tubular sections, each approximately 4 feet long. The lower section has a metal point for embedding in the ground, and both sections are provided with halves of a joint-and-catch fitting. The parts are painted with alternate 4-inch red and white bands. A canvas cover, holding both sections, is provided. Should it be necessary to drive the lower section into the ground, interpose a wood block or use other means to insure that the surface mating with the upper part will not be injured.

**96. AIMING POST LIGHT, M14**

a. The light, aiming post, M14, is a satisfactory device for illuminating aiming posts for night firing. It is a replacement for aiming lanterns, M1 and M2.

b. The light, aiming post, M14 (fig. 143), consists of a battery case for two BA-30 batteries (one in each end to obtain a parallel circuit), with a lamp housing and a toggle switch. A metal hood is provided for the lamp. When the hood is not in use, it is carried around the battery case. Illumination is furnished by 3-volt aircraft instrument panel lamp with

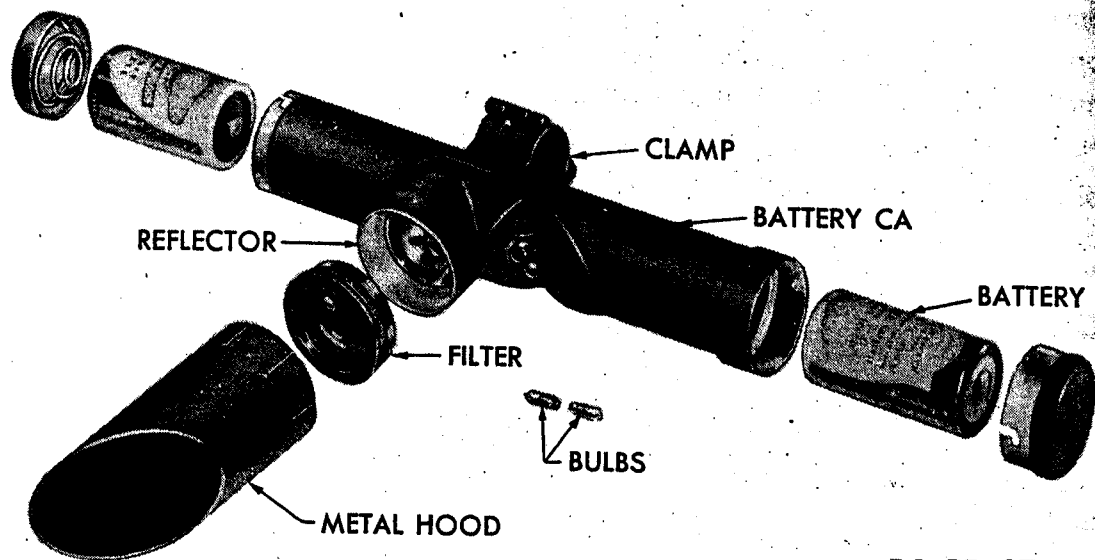

RA PD 37666

Figure 142—Exploded view of aiming post light, M14

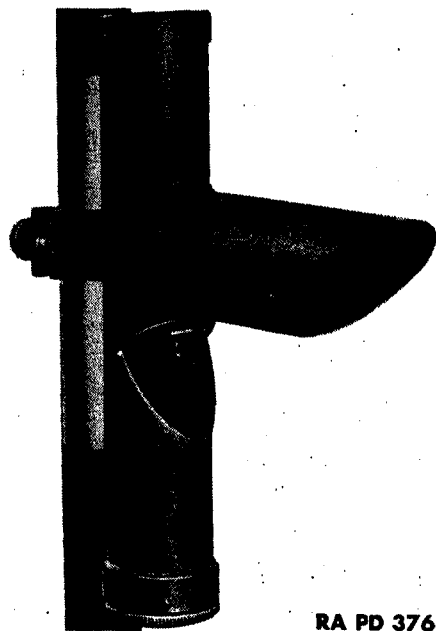

Figure 143—Aiming post light, M14,  
in position on aiming post

which standard instrument lights are now equipped. A reflector is mounted in the back of the lamp and a color filter can be attached to the front of the lamp housing (fig. 142).

c. A clamp is provided to secure the lamp to the aiming post.

d. A chest is provided to carry a section set, comprising two aiming post lights, (one with red, one with green filters); eight BA-30 batteries; and two spare lamps.

e. The batteries should always be removed from the battery case when not in use in order that their deterioration on long standing will not damage the light. When not in use,

the various parts of the light should be kept in the chest provided.

## 97. GUNNER'S QUADRANT, M1

a. **General.** The gunner's quadrant is an instrument used to measure the elevation of the piece and to lay the piece to a given elevation. In use, it is seated on the leveling plates in the top of the breech ring of the gun.

b. **Description.** This quadrant (fig. 144) includes a sector-shaped frame to which is pivoted an arm carrying a level. Notches on the

CATIONS

SIGHTING EQUIPMENT

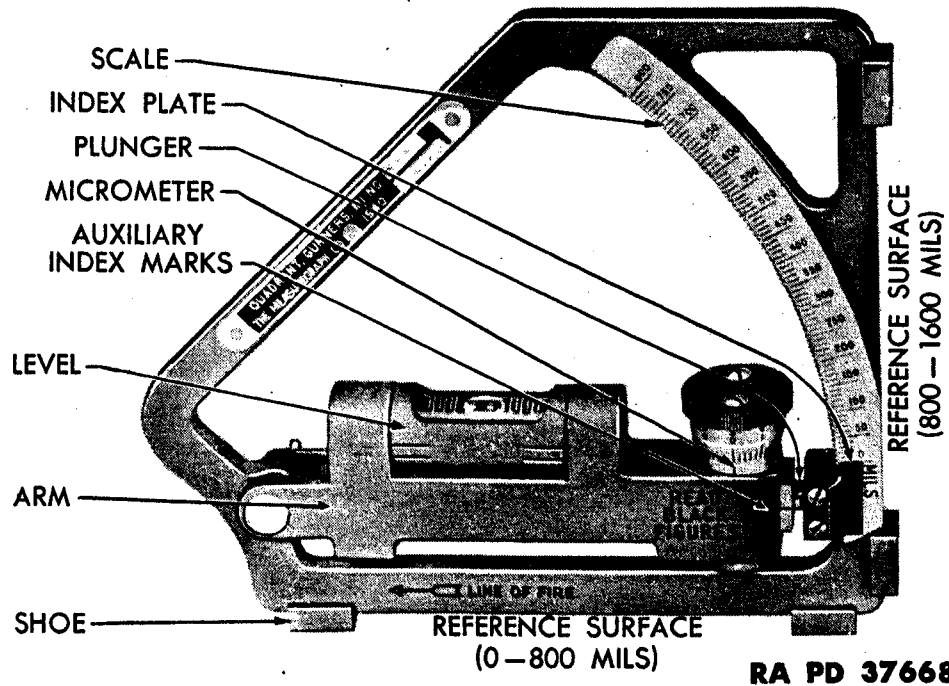

Figure 144—0 to 800 mil side of gunner's quadrant, M1

frame engaging with a plunger in the arm permit rapid setting of the arm to the desired angle. The frame has two reference surfaces, one used for elevations from 0 to 800 mils and the other from 800 to 1600 mils. Separate scale and micrometer indications on opposite sides of the quadrant are used for the two different regions.

c. Operation. (1) To measure the elevation of the piece, place the proper reference surface of the quadrant on the leveling plates, parallel to the bore, with the associated arrow pointing in the direction of fire. Set the micrometer to zero. Disengage the plunger from the notches in the frame, lift the arm and slowly lower it until the bubble is seen to pass through the central point. Allow the plunger to engage with the notches and turn the micrometer until the level bubble is accurately centered. Face the side of the quadrant which bears the arrow in use and read the scale and micrometer indications. A note, engraved below the micrometer, indicates whether the red or the black micrometer figures are to be read; a zero micrometer indication is read as "0 mils" when the auxiliary indexes are matched (as shown), and as "10 mils" when they are not matched. The elevation of the piece in mils is equal to the sum of the scale and micrometer readings. Remove the quadrant from the piece before firing.

(2) To measure depression angles, proceed as above, but with the arrow pointed in the reverse direction.

(3) To lay the piece to a given elevation, set the scale and micrometer to the required angle and place the corresponding fiducial surface

155-MM GUN MATERIEL, M1917, M1918 AND MODIFICATIONS

on the leveling plates of the piece. Elevate the piece, then depress it until the level bubble is centered. Remove the quadrant from the piece before firing.

d. **Test and adjustment.** No adjustment of the quadrant by the using arm is permitted. The zero indication may be verified by setting the quadrant to zero elevation, elevating or depressing the piece to center the bubble, then turning the quadrant end for end. If the bubble is not centered, determine the elevation or depression angle necessary to center it; one-half of this angle is the error and a corresponding correction should be applied to all subsequent indications in the 0-800 mil region.

e. **Care and preservation.** (1) Exercise particular care to prevent burring, denting, or nicking of the shoes and of the notched portion of the frame.

(2) Never leave the quadrant on the piece when firing.

(3) When not in use, keep the quadrant in the chest provided, with the shoes lightly greased.

98. GUNNER'S QUADRANT, M1918

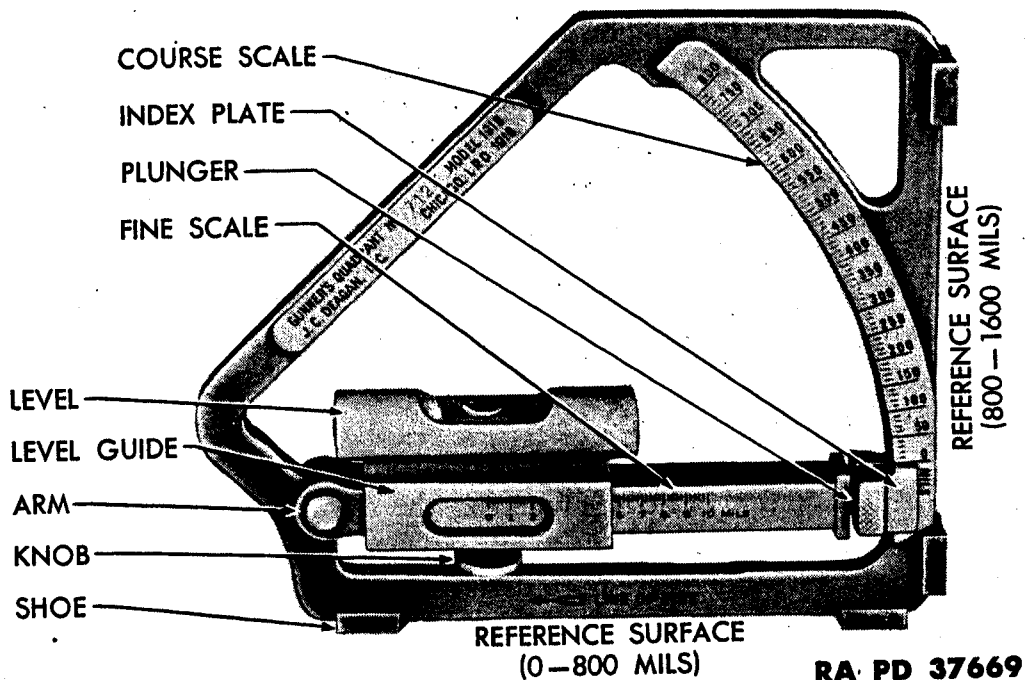

Figure 145—0 to 800 mil side of gunner's quadrant, M1918

a. **General.** The gunner's quadrant is an instrument which, seated on the leveling plates in the top of the breech ring of the gun, is used to measure the elevation of the piece and to lay the piece to a given elevation.



## SIGHTING EQUIPMENT

b. **Description.** This quadrant (fig. 145) includes a sector-shaped frame to which is pivoted an arm carrying a level. Notches on the frame, engaging with a plunger in the arm, permit rapid setting of the arm in 10-mil steps to the desired angle as indicated on the coarse scale. The arm is slightly curved and the level guide is positioned along the arm to provide a fine indication supplementing that on the coarse scale. The frame has two reference surfaces, one used for elevations from 0 to 800 mils and the other from 800 to 1600 mils. Separate indications on opposite sides of the quadrant are used for the two different regions.

c. **Operation.** (1) To measure the elevation of the piece, place the proper reference surface of the quadrant on the leveling plates, parallel to the bore, with the associated arrow pointing in the direction of fire. Clamp the level guide to indicate zero on the fine scale. Disengage the plunger from the notches in the frame, lift the arm and slowly lower it until the bubble is seen to pass through the central point. Allow the plunger to engage with the notches and slide the level guide along the arm until the level bubble is accurately centered. Face the side of the quadrant which bears the arrow in use and read the coarse and fine scales. The elevation of the piece in mils is equal to the sum of the coarse and fine scale readings. Remove the quadrant from the piece before firing.

(2) To measure depression angles, proceed as above, but with the arrow pointed in the reverse direction.

(3) To lay the piece to a given elevation, set the scale and micrometer to the required angle and place the corresponding reference surface on the leveling plates of the piece. Elevate the piece, then depress it until the level bubble is centered. Remove the quadrant from the piece before firing.

(4) The gunner's quadrant may also be used instead of a machinist's level during verification and adjustment of the sights. When so used, it is important that the zero indication be accurately verified as described below. In some cases, it is necessary to interpose a parallel plate or parallel bar between the surface to be leveled and the reference surfaces on the frame, in which case, the verification of the zero indication on the quadrant should be performed so as to correct for any error of the parallel plate or bar.

d. **Test and adjustment.** No adjustment of the quadrant by the using arm is permitted. The zero indication may be verified by setting the quadrant to zero elevation, elevating or depressing the piece to center the bubble, then turning the quadrant end for end. If the bubble is not centered, determine the elevation or depression angle necessary to center it; one-half of this angle is the error, and a corresponding cor-

## 155-MM GUN MATERIEL, M1917, M1918 AND MODIFICATIONS

rection should be applied to all subsequent indications in the 0-800 mil region.

e. Care and preservation. (1) Refer to paragraph 93, for general instructions pertaining to the care and preservation of instruments.

(2) Exercise particular care to prevent burring, denting, or nicking of the reference surfaces and of the notched portion of the frame.

(3) Do not leave the quadrant on the piece when firing.

(4) When not in use, keep the quadrant in the chest provided, with the shoes forming the reference surfaces lightly greased.

### 99. BORE SIGHT

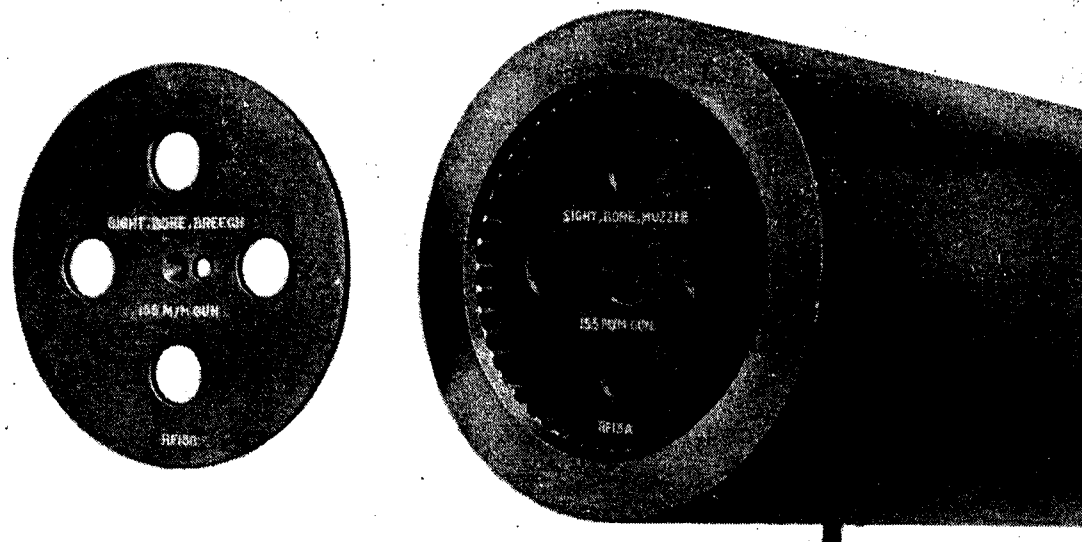

RA PD 37670

Figure 146—Breech bore sight and muzzle bore sight (in gun)

a. Description. The bore sight (fig. 146) consists of a breech bore sight and a muzzle bore sight designed for insertion in the respective ends of the gun bore.

b. Operation. For use of this item of sighting equipment, see Bore Sighting, under Tests and Adjustments, paragraph 94 g (3).

c. Care and preservation. Handle the bore sights carefully to prevent nicks and burs. Keep the bore sights lightly greased when not in use.

### 100. TESTING TARGET

The testing target (fig. 147) is used during the bore sighting operation [see par. 94 g (3)] for the alinement of sights and sub-caliber

15.646

C  
E  
S  
1

### SIGHTING EQUIPMENT

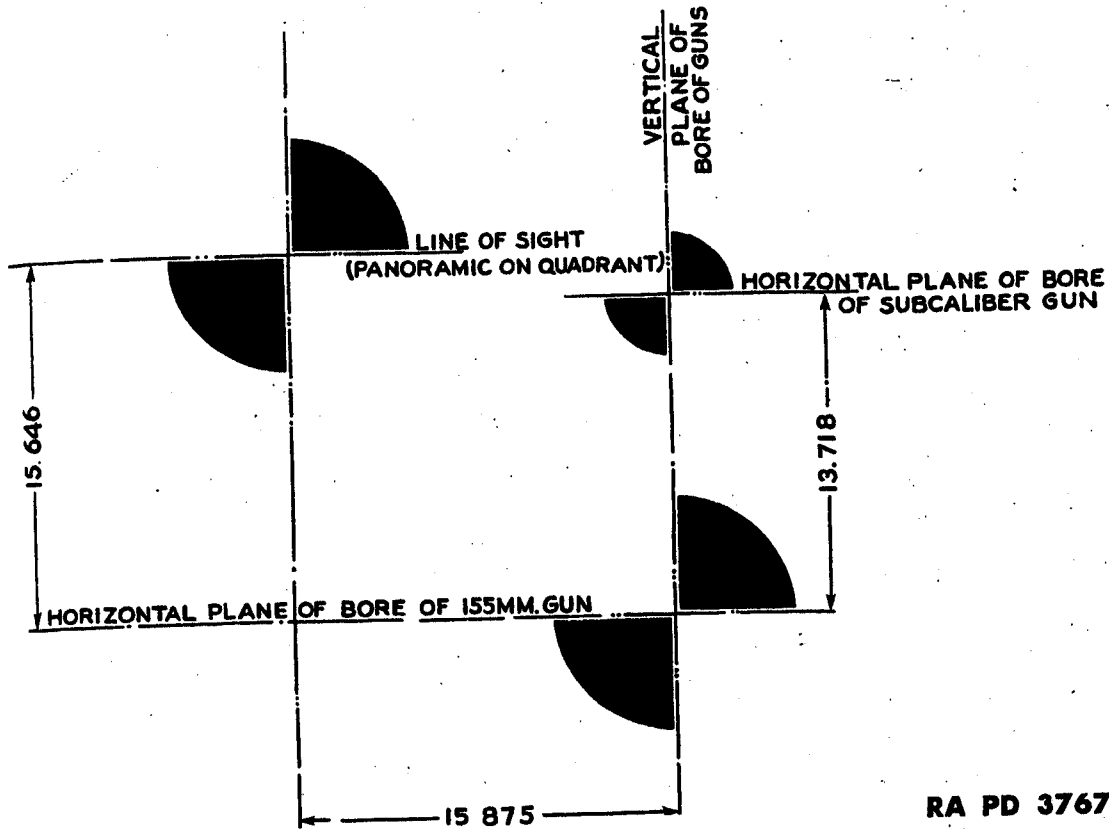

RA PD 37671

**Figure 147—The testing target used to align the sights and sub-caliber equipment with the bore of the 155-mm guns**

equipment with the axis of the bore of the gun. The several aiming points are plainly designated. It is essential that the proper aiming points be selected for the materiel and equipment employed, and that the target be positioned in a vertical plane when in use. The normal distance from the gun at which the target should be located is about 50 yards.

IONS  
e 0-800  
93, for  
f instru-  
nicking  
e.  
rovided,

70

breech  
ective  
nt, see  
).  
lly to  
en not  
opera-  
aliber

155-MM GUN MATERIEL, M1917, M1918 AND MODIFICATIONS

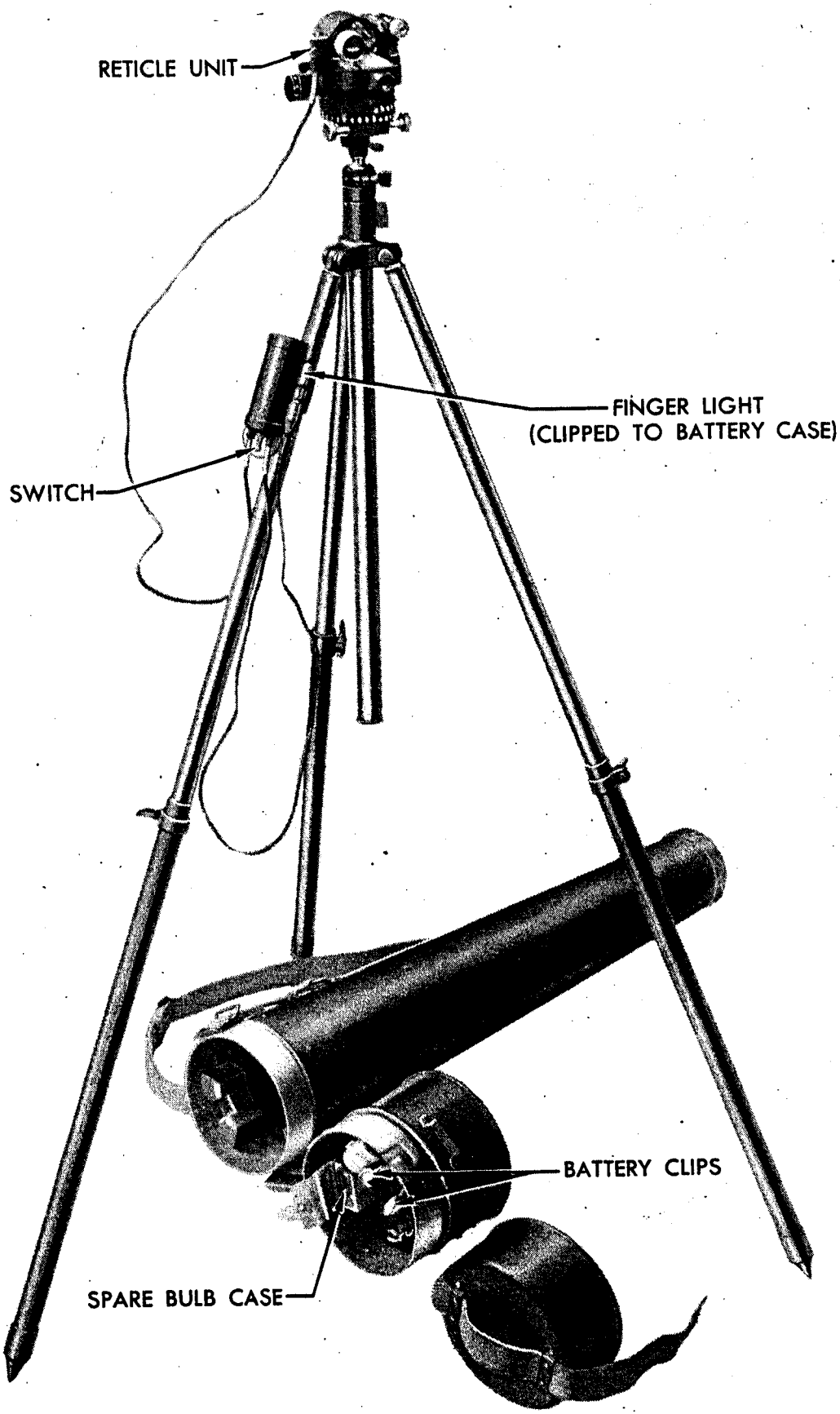

Ge  
Air  
Cc  
Gr  
H  
B  
1  
1  
1

RA PD 37672

Figure 148—Aiming circle, M1, with instrument light, M2, and carrying case. Tripod is positioned properly for use

FICATIONS

Section XII

FIRE-CONTROL EQUIPMENT

	Paragraph
General.....	101
Aiming circle, M1.....	102
Compasses.....	103
Graphical firing tables.....	104
Hand fuze setter, M1913.....	105
B. C. telescope, M1915A1.....	106

101. GENERAL

The fire control equipment authorized for use with the 155-mm guns, M1917, M1917A1 and M1918M1, is:

a. The aiming circle, M1 (with instrument light, M2), used for measuring angles in azimuth and site, and for general topographical work. Limited standard items for this application are. aiming circle, M1918, (with instrument light, M4); aiming circle, M1916; and aiming circle, M1916MI.

b. The prismatic compass, M1918 (Sperry), and the compass, M3, used for measuring angles of site, clinometer angles, and magnetic azimuths.

c. The graphical firing tables, M6 and M15, used to simplify and speed up the conduct of fire, and to help reduce the probability of error.

d. The hand fuze setter, M1913, used for setting the powder-train fuzes of shrapnel, where shrapnel is provided for training or combat.

e. The battery commander's telescope, M1915A1, (with instrument light, M1), used for observation and for measurement of azimuth and angle of site.

102. AIMING CIRCLE, M1

a. Description. This instrument (fig. 148) is used for measuring angles in azimuth and site, and for general topographical work. It includes a four-power telescope with a laterally and vertically graduated reticle, two levels, a declinator, elevating, orienting, and azimuth mechanisms, and azimuth scales and micrometers. Azimuth indications are in mils, numbered to correspond to the scale indications of other instruments commonly used with the aiming circle. No scale other than that on the reticle is provided for vertical angles. The instrument is furnished complete with tripod and carrying case (fig. 148).

IT  
Y CASE)

72

155-MM GUN MATERIEL, M1917, M1918 AND MODIFICATIONS

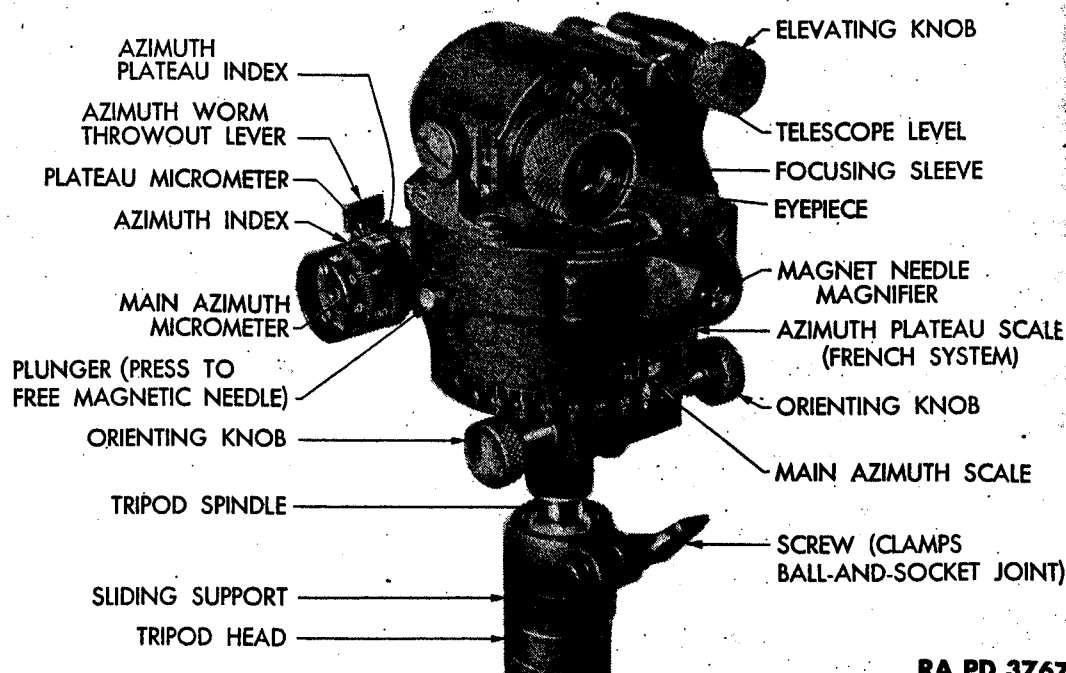

RA PD 37673

Figure 149—Left rear view of aiming circle, M1

b. Description of instrument light. All aiming circles, M1, are being equipped with the instrument light, M2, which includes a battery case connected by flexible cords to a reticle unit and a finger light. The battery case, containing one flashlight cell, is arranged to be clamped to a tripod leg and has a switch controlling both lamps. The reticle unit snaps in place in a dovetailed slot over the reticle illuminating window. The finger light has a soft rubber housing, and is held in a spring clip on the battery case, when not in use. The aiming circle carrying case is being modified to permit storage of the flashlight cell and spare cell and spare bulbs separately from the battery case (fig. 148).

c. Operations. (1) To set up the instrument, clamp the tripod legs at the desired length, and embed them firmly in the ground. Clamp the sliding support of the tripod at the desired height. Level the instrument, using the circular level and the ball-and-socket joint. Focus the telescope as required, using the sleeve on the eyepiece.

(2) To orient the instrument, either a datum point of known azimuth, or magnetic bearings may be used.

(a) To orient on a datum point of known azimuth, set the main azimuth scale (100-mil steps) and micrometer (1-mil steps) to the azimuth of the datum point, and turn one of the orienting knobs until the datum point appears on the vertical cross line of the reticle. The instrument may also be relocated on the tripod spindle, using the orienting clamping screw for large angular changes. The telescope may be elevated or depressed, as required, to bring the point in the field of view.

### FIRE-CONTROL EQUIPMENT

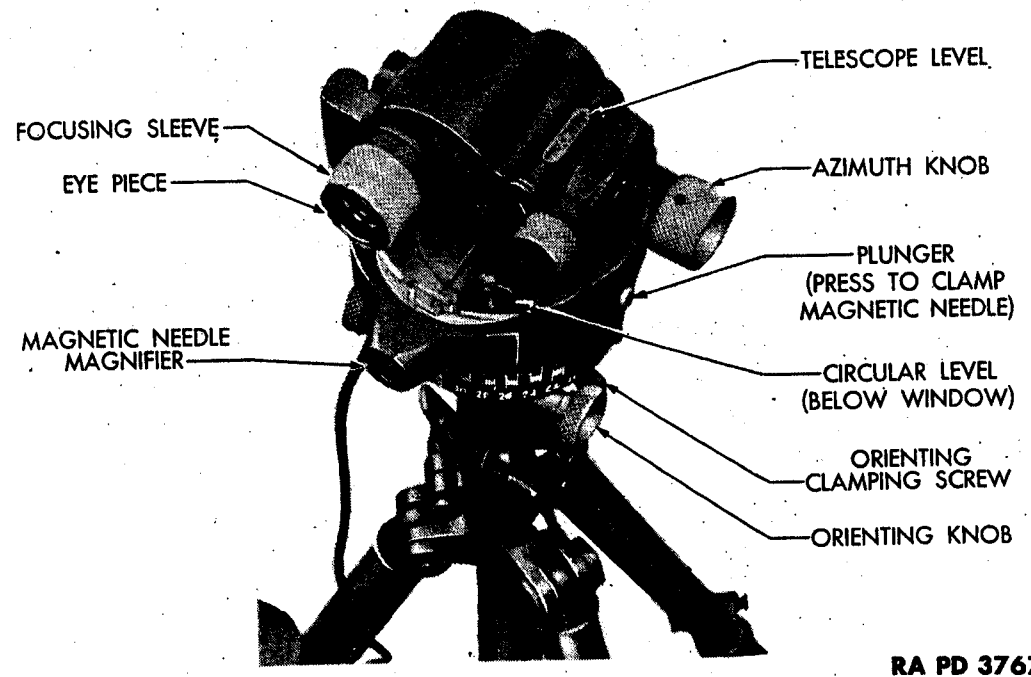

RA PD 37674

Figure 150—Top right rear view of aiming circle, M1

(b) To orient on magnetic north, set the main azimuth scale and micrometer to indicate zero. Press the plunger releasing the magnetic needle, and turn one of the orienting knobs until the north-seeking (knife edge) end of the magnetic needle appears approximately opposite the "N" index at the front of the instrument, then refine the setting so that the south-seeking (rectangular) end of the needle is centered in the reticle, viewed through the magnifier. The instrument may also be relocated on the tripod spindle, using the orienting clamping screw for large angular changes. The aiming circle will then indicate magnetic azimuths.

(c) To orient on grid north, proceed as for magnetic north, but set the azimuth to the magnetic declination of the locality (subtracting west declinations from 6400 mils), instead of to zero. The instrument will then indicate grid azimuths.

(d) When orientation by magnetic bearings has been completed, press the red plunger to clamp the magnetic needle.

(3) To read angle of site, rotate the elevating knob so that the bubble of the telescope level is centered. The angle of site of an object is then indicated by its position on the graduations at 5-mil intervals along the vertical cross line of the reticle. Angles of site, thus measured, are limited to  $\pm 85$  mils and no other indicating means are provided.

(4) To read azimuth, bring the object on the vertical cross line of the reticle, using the azimuth knob; the throwout lever may be de-

## 155-MM GUN MATERIEL, M1917, M1918 AND MODIFICATIONS

pressed for making large azimuth changes rapidly. The azimuth indications of this instrument may be read either directly in mils, or in terms of the indications on the panoramic telescope as follows:

- (a) Azimuths from 0 to 6400 mils are read directly on the azimuth scale, using the main (upper) graduations for values from 3200 mils up. Indications on this scale are at 100-mil intervals, and are supplemented by those on the azimuth micrometer, which is graduated at 1-mil intervals.
- (b) Angular indications corresponding to those of the panoramic telescope, M6, (0-3200, 0-3200 mil scales) are similarly read, using the auxiliary (lower) graduations for azimuths over 3200 mils.
- (c) Small angles may be measured along the horizontal cross line of the reticle, which is graduated at 5-mil intervals.
- (d) The azimuth plateau scale and micrometer are for use with the sighting equipment on certain 75-mm gun carriages.
- (5) To prepare the instrument for traveling, place it in the carrying case provided. The instrument need not be removed from the tripod.

d. Tests and adjustments. (1) The azimuth and plateau micrometers should read 0 and 100, respectively, when the azimuth scale indicates zero. Three screws in the end of the azimuth micrometer may be temporarily loosened for this adjustment.

(2) The telescope level should indicate the line of sight determined by the center of the reticle to be horizontal. This may be verified by sighting on a distant point at the same level as the telescope, the error, if any, being read on the reticle. No corrective adjustment by the using arm is permitted. A celluloid strip is provided on the front of the instrument, on which any correction should be recorded.

(3) To check the accuracy of the declinator, it is necessary to set up the instrument in a position not subject to local magnetic attraction, and sight on one or (preferably) more points of known azimuth. The average error should be noted and the necessary correction recorded on the celluloid strip. No adjustment by the using arm is permitted.

e. Care and preservation. (1) Refer to paragraph 93 for general instructions pertaining to the care and preservation of instruments.

(2) Exposed moving parts should be oiled occasionally. Interior parts are not to be lubricated by the using arm. Keep excessive lubricant that seeps from the mechanisms wiped off to prevent accumulation of dust and grit.



## FIRE-CONTROL EQUIPMENT

(3) When storing aiming circles equipped with instrument lights, remove the flashlight cell from the battery case and place it in the compartment of the aiming circle carrying case.

## 103. COMPASSES

a. Prismatic compass M1918 (Sperry). This instrument (fig. 151) is used for measuring angles of site, clinometer angles, and magnetic azimuths. The prismatic compass M1918 (Sperry) will be used until the compass, M2, which is the present standard, becomes available (see b of this paragraph).

(1) Description This instrument is furnished complete with a carrying case but without a tripod. The instrument includes a compass dial (green) carrying a magnetic needle and azimuth scales, a weighted clinometer dial (white), and a sighting system whereby angular indications may be read while observing the object.

(2) Operation. (a) To measure angles of site, raise leaf sight and rear sight. Pull out clinometer wedge knob to permit free rotation of clinometer dial. Focus rear sight on clinometer (white) dial, sliding sight as required and clamping it in position with rear sight knob. Hold instrument with dials in a vertical plane, look through niche in rear sight, and elevate or depress instrument until object observed is in line with horizontal central vane of leaf sight. The angle of site, reflected in rear sight prism, will also be visible in the center of the field of view. The angle of site scale (outer scale on clinometer dial) is graduated at 5-mil intervals and numbered at 100-mil intervals. The 50-mil points are also marked. A 300-mil indication corresponds to a level line of sight, as on the corresponding scales of range quadrants. The clinometer wedge knob may be partially depressed to damp out oscillations. It must not be depressed when taking the reading.

(b) To measure azimuths, first operate the instrument in angle of site until the compass (green) dial is exposed at rear sight by cutaway portion of clinometer (white) dial. Depress clinometer wedge knob. Raise leaf sight and rear sight. Focus rear sight on compass (green) dial, sliding sight as required and clamping it in position with rear sight knob. Hold instrument in hand or support it on a convenient nonmagnetic body. Look through niche in rear sight and rotate instrument in azimuth until the object observed is in line with the vertical central vane of the leaf sight. The magnetic azimuth, reflected in rear sight prism, will also be visible in the center of the field of view. The compass dial is graduated at 10-mil intervals and numbered at 100-mil intervals. Additional

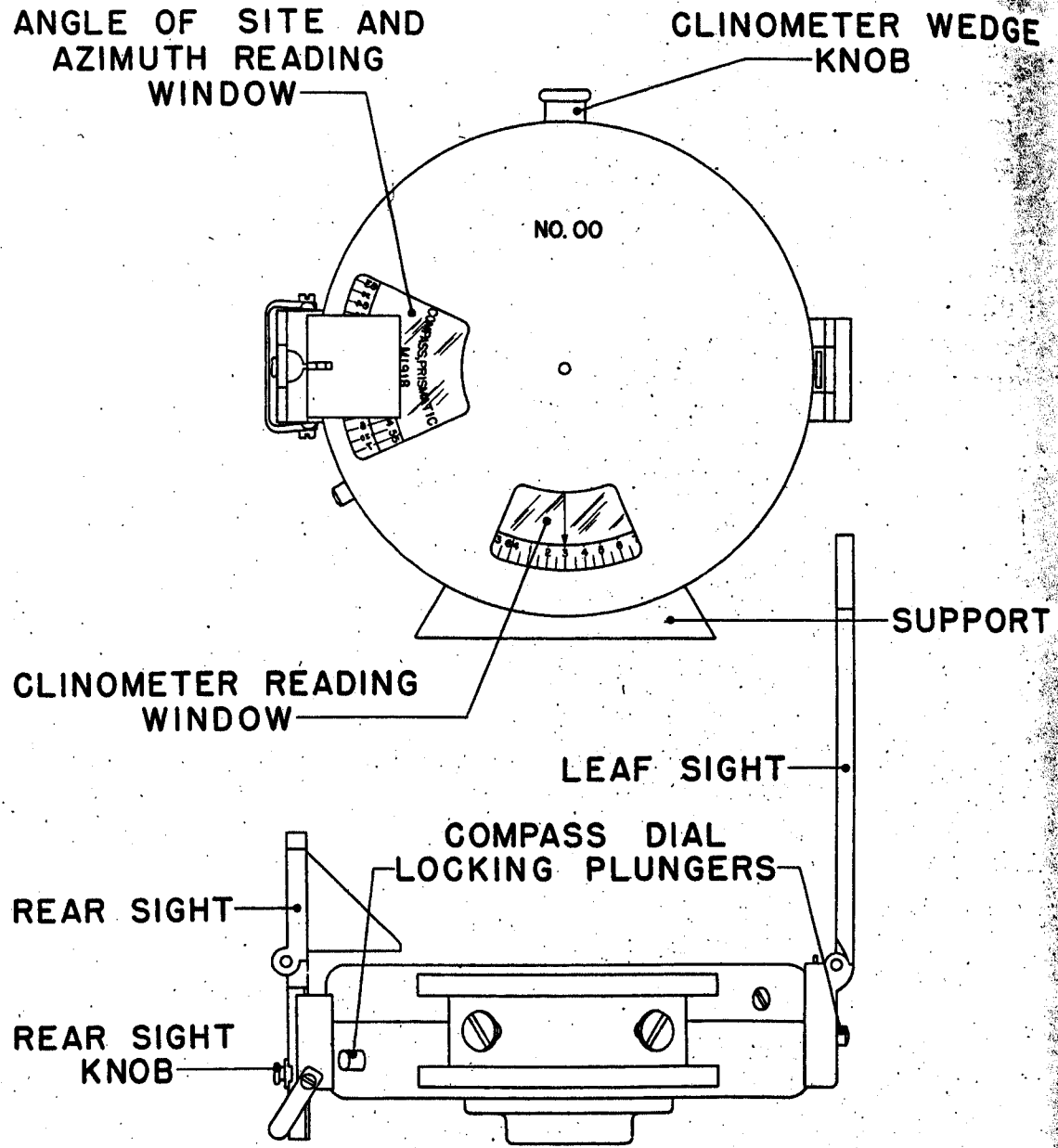

RA FSD  
480

Figure 151—Prismatic compass, M1918 (Sperry)

## FIRE-CONTROL EQUIPMENT

numbering is provided in the 3200-6400-mil half of the scale to correspond to the numbering on azimuth scales of panoramic telescopes which are graduated 0-3200-mils in this range. To damp out oscillations of compass dial, gently depress one of the locking plungers. Plungers must not be in depressed position when taking the azimuth reading.

(c) To use the instrument as a clinometer, pull out clinometer wedge knob and stand instrument, prism to the rear, on its support, on a straight portion of the piece which is parallel to the bore. The reading of clinometer scale, read opposite an etched line on clinometer reading window, is the elevation of the piece. The clinometer scale is graduated at 10-mil intervals and numbered at 100-mil intervals. A 300-mil reading indicates bore of the piece to be level. Sights should not be raised when using instrument only as a clinometer. The clinometer wedge knob may be partially depressed to damp out oscillations. It must not be depressed when taking the reading.

(d) To prepare instrument for traveling, push in clinometer wedge knob (clamping clinometer dial) and turn leaf sight down (clamp the compass dial). Lower and fold back rear sight, securing it in place with the catch. Place instrument in case provided.

(3) Test and adjustment. Accuracy of azimuth and angle of site indications may be checked by sighting on datum points of known azimuth and elevation. When placed on a flat level surface, the clinometer should indicate 300. No adjustment by the using arm is permitted.

(4) Care and preservation. (a) See par. 93 for general instructions pertaining to care and preservation of instruments.

(b) When not in use keep leaf sight down, clamping compass dial, and clinometer wedge knob depressed, clamping clinometer dial, thus preventing injury to and excessive wear of their respective pivots.

(c) Observe particular care to prevent bending of the leaf sight parts.

(d) No lubrication of the instrument is required.

b. Compass M2. (1) General. The compass M2 (figs. 152 and 153) is a multiple-purpose instrument used for measuring angles of site, clinometer angles, and magnetic azimuths. It has been adopted as standard to replace the prismatic compass M1918 (Sperry) which has been reclassified as limited standard.

DIFICATIONS

FER WEDGE  
VOB

SUPPORT

FSD  
BO

## 155-MM GUN MATERIEL, M1917, M1918 AND MODIFICATIONS

(2) Description. The compass weighs about 8 ounces, and measures over-all about  $2\frac{3}{4}$  by  $2\frac{3}{4}$  by  $1\frac{1}{8}$  in. when closed. It consists of a compass and angle of site mechanism contained in a body with a hinged cover. When the cover is closed, it lifts the magnetic needle from its pivot and clamps it securely for traveling. The north-seeking end of the magnetic needle is painted white. The compass scale can be oriented on grid (Y) north for any locality. Front and rear sights, together with a mirror in the cover, permit measurements to be made while observing the object.

(3) Accessories. The compass is furnished complete with carrying case M19. The case is velveteen-lined and has a leather loop on the back for carrying the user's belt.

(4) Operation. Compass operating positions are shown in figures 154 and 155. The compass should be held as rigidly as possible to obtain the most accurate readings. The use of a sitting or prone position, a rest for the hands or elbows, or a solid support for the compass will help to eliminate unintentional movement of the instrument. When measuring angles in azimuth, the compass should be used away from steel or iron masses which would distort the local magnetic field. The time of oscillation of the magnetic needle can be shortened by partially depressing the needle locking pin, or the average position of the needle in its swing may be used. Practice in the operation of the compass greatly increases the proficiency and accuracy attained by the operator.

(5) To measure angles in azimuth by reading reflected image of azimuth scale. Hold the opened compass in both hands at eye level, with arms braced against body and the rear sight nearest the eyes. Place the cover at an angle of approximately  $45^\circ$  to the face of the compass (fig. 154) so that the reflected scale can be readily viewed. Level the instrument by means of the reflected circular level, sight on the desired object, and read the azimuth in the reflected image of the scale. The azimuth reading is indicated on the azimuth scale by the south-seeking (black) end of the compass needle. When sighting, hold hands rigid and turn body. The instrument can be sighted by any of the methods below. More accurate readings result from the use of a longer sight base.

(a) Raise the rear sight holder approximately perpendicular to the face of the compass. Sight on the object through the opening in the rear sight holder and through the window in the cover (fig. 154). Keep the compass level and raise or lower the eye along the opening in the rear sight holder until the black center line of the window bisects the object and the opening in the rear sight.

(b) Fold the rear sight holder out parallel with the face of the compass, with the rear sight perpendicular to its holder. Sight

## FIRE-CONTROL EQUIPMENT

through or over the rear sight and view the object through the window in the cover. If the object sighted is at a lower elevation than the compass, raise the rear sight holder as needed. The compass is correctly sighted when the compass is level and the operator sees the black center line of the window bisecting the rearsight and the object sighted.

(c) Raise the front sight and the extended rear sight assembly perpendicular to the face of the compass. Sight over the tips of the rear and front sights. If the object is above the line of sighting, fold the rear sight toward the eye as needed. The instrument is correctly aligned when, with the level centered, the operator sees the tips of the sights and the center of the object sighted in coincidence.

(6) To measure angles in azimuth by reading azimuth scale directly. (a) Hold the opened compass in both hands (at about waist level), braced against the body, with the rear sight away from the body. Open the cover until the mirror affords a clear image of the object sighted. Extend the rear sight and raise the rear sight assembly until it is approximately perpendicular to the face of the compass. Level the instrument by means of the circular level. Holding arms rigid with the instrument level, turn body until the center line on the mirror bisects the opening in the rear sight holder and the mirror image of the object sighted.

(b) Then read the azimuth indicated on the azimuth scale by the north-seeking (white end of the compass needle.)

(7) To measure angles of site. (a) Hold the opened compass in a vertical plane as in fig. 56 with the rear sight toward the body and the angle of site level lever to the right. Open the cover to an angle of approximately  $45^\circ$  to the face of the compass. Fold the rear sight holder out parallel to the face of the compass with the rear sight perpendicular to the holder.

(b) Look through the rear sight and raise or lower the instrument until the center line of the window bisects the opening in the rear sight and the object sighted.

(c) Then level the tubular level reflected in the mirror, by means of the lever. Open the cover and read the angle of site opposite the index.

(d) Care must be exercised to maintain the compass in a vertical plane to obtain accurate readings.

(8) To measure clinometer angles. Open the cover and rear sight holder parallel with the face of the compass. Place the edge of the opened compass on the leveling plates of the piece, center the bubble of the tubular level, and read the angle of site.

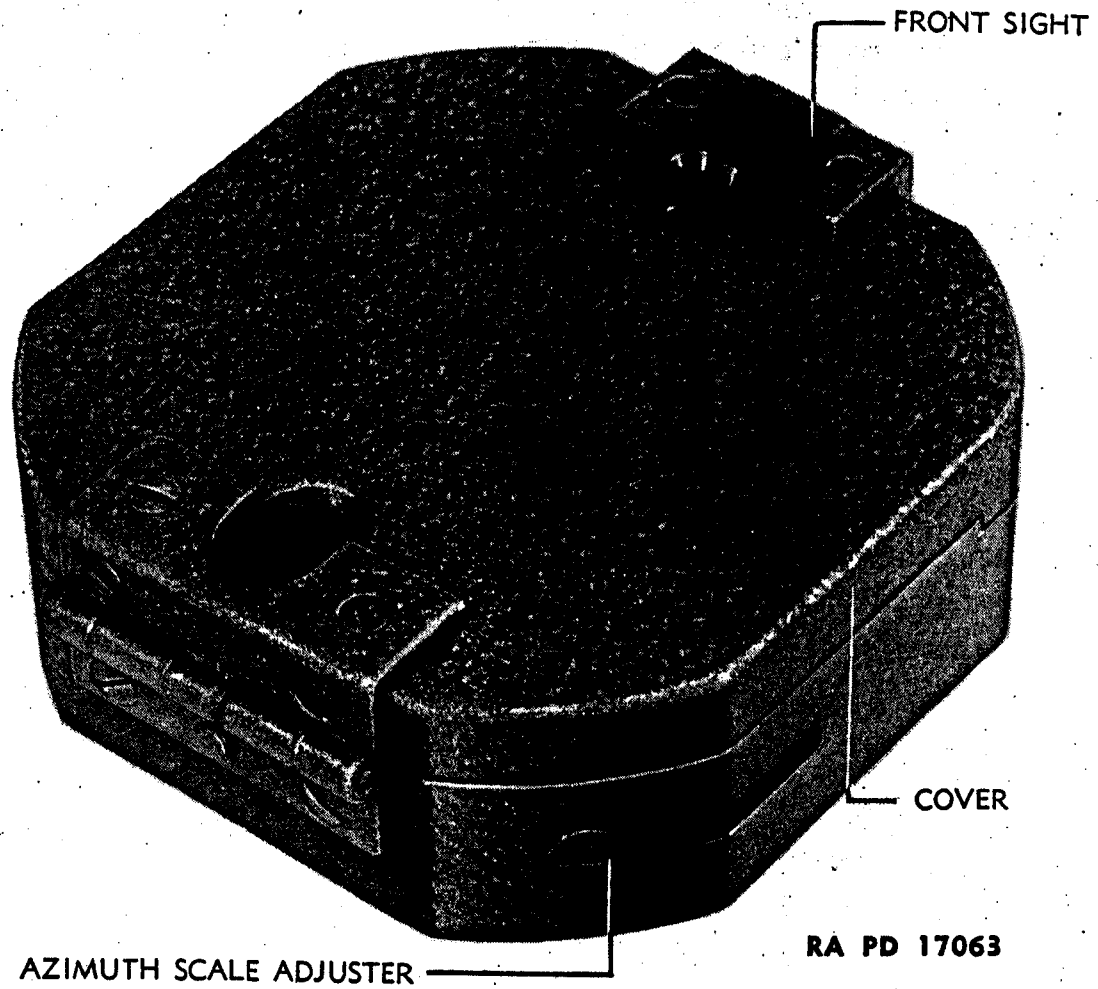
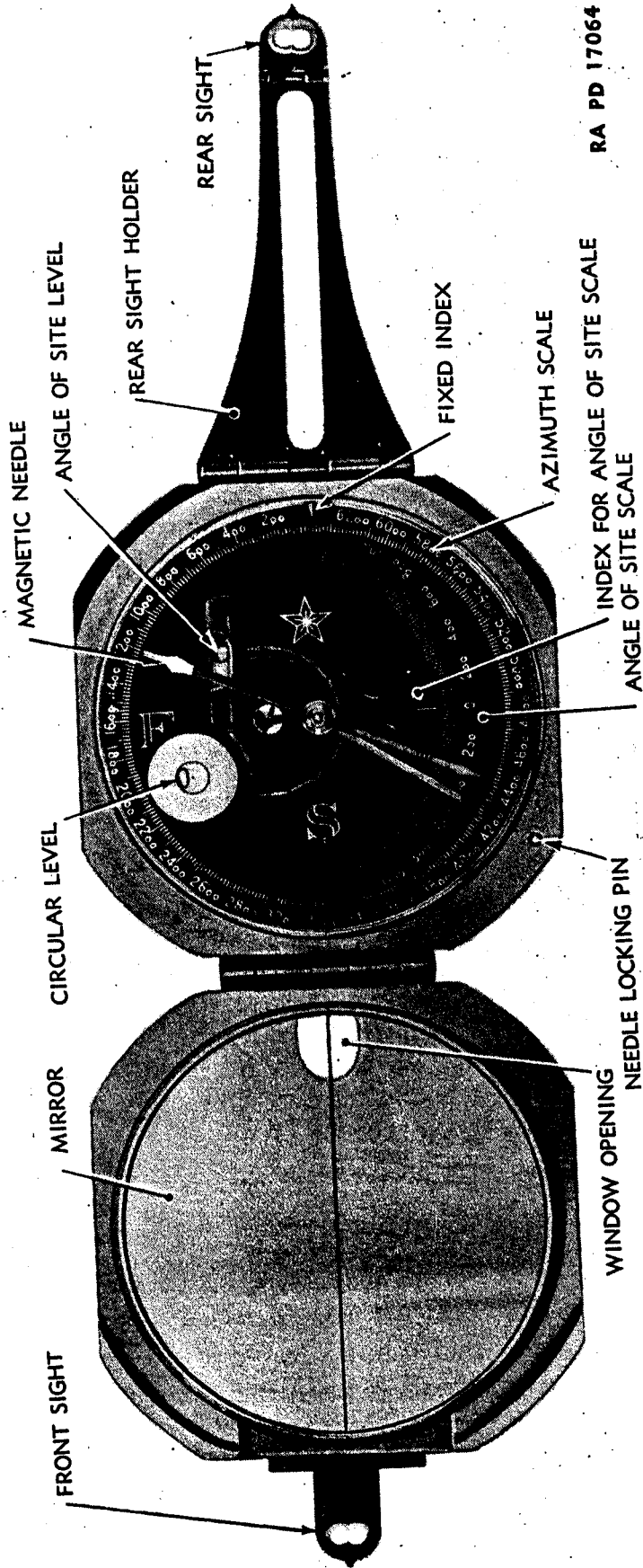

Figure 152—Compass, M2, cover closed

FIRE-CONTROL EQUIPMENT

TIONS

SIGHT



RA PD 17064

Figure 153—Compass, M2, cover open

**155-MM GUN MATERIEL, M1917, M1918 AND MODIFICATIONS**

- (9) Orientation on grid (Y) north. (a) The standard reference direction for compass readings is grid (Y) north, corresponding to the grid indications on standard maps. However, due to regional differences in magnetic direction and local disturbances in the magnetic field, the magnetic needle in the compass may point several degrees to either side of the reference direction. The difference between the magnetic direction and the standard reference direction is the declination constant.
- (b) Allowance for declination constant can be made in this compass by orienting (shifting) the azimuth scale, using the azimuth scale adjuster. The slotted head of the adjuster can be turned with an ordinary screw driver.
- (c) To determine the declination constant, open the compass and set zero of the azimuth scale against the fixed index in the body by means of the azimuth scale adjuster. Take compass readings on several points of known azimuth. Compute the difference between the compass reading (mean of three readings) of each of the points and the known grid (Y) azimuth. The mean of these differences is the declination constant of the instrument for the particular locality.
- (d) If the azimuth readings are greater than the grid azimuths, subtract the declination constant from the azimuth readings or rotate the azimuth scale the amount of the declination constant in a counterclockwise direction by means of the azimuth scale adjuster. If the azimuth readings are less than the grid azimuths, add the declination constant to the azimuth readings or rotate the azimuth scale in a clockwise direction. This orients the compass on grid (Y) north.
- (e) An alternate method of finding the declination constant is to use an isogonic chart. This method is less accurate as it does not consider local disturbances in the magnetic field.
- (f) If the compass is to be used in another locality six or more miles distant, redetermine the declination constant for that locality.
- (10) Adjustment. Adjustment for dip of the magnetic needle and errors in the circular and tubular levels may not be made by using arms personnel. However, errors in the tubular level may be determined by comparison against a level or gunner's quadrant of known accuracy. If the error remains constant, it can be compensated for in measuring angles of site or when using the instrument as a clinometer.
- (11) Care and Preservation. (a) The compass should be handled carefully to avoid unnecessary shocks. It should be closed and kept in the carrying case when not in use. After use in wet



FIRE-CONTROL EQUIPMENT.

CATIONS  
dard refer  
responding  
to regional  
ces in the  
int several  
difference  
direction

s compass  
uth scale  
with an

pass and  
he body  
lings on  
between  
e points  
ferences  
rticular

muths,  
ngs or  
nstant  
scale  
muths,  
te the  
mpass

is to  
not

files

edle  
ing  
ned  
cy.  
ng

be  
ed  
et

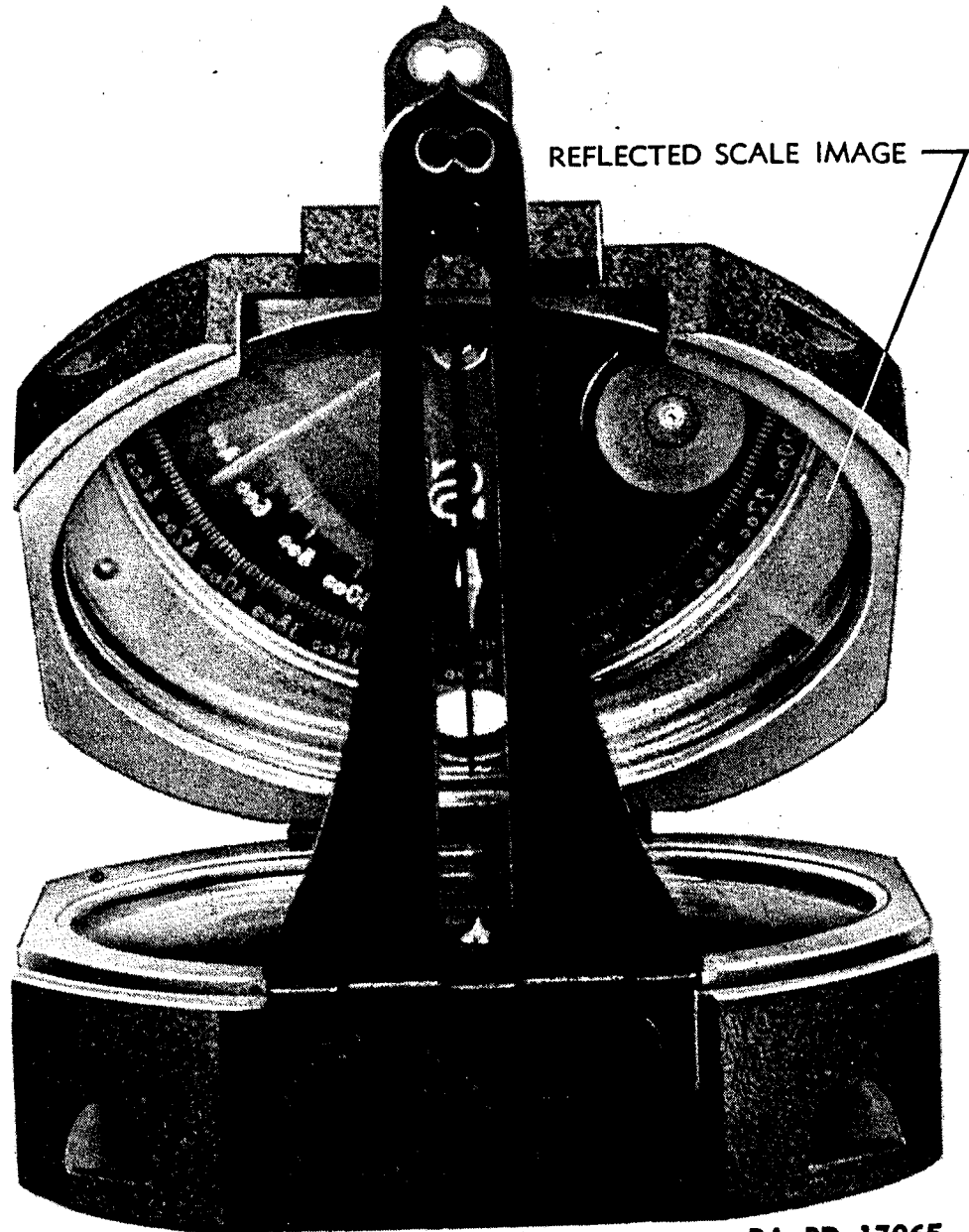

RA PD 17065

Figure 154—Compass, M2, observer's view, azimuth

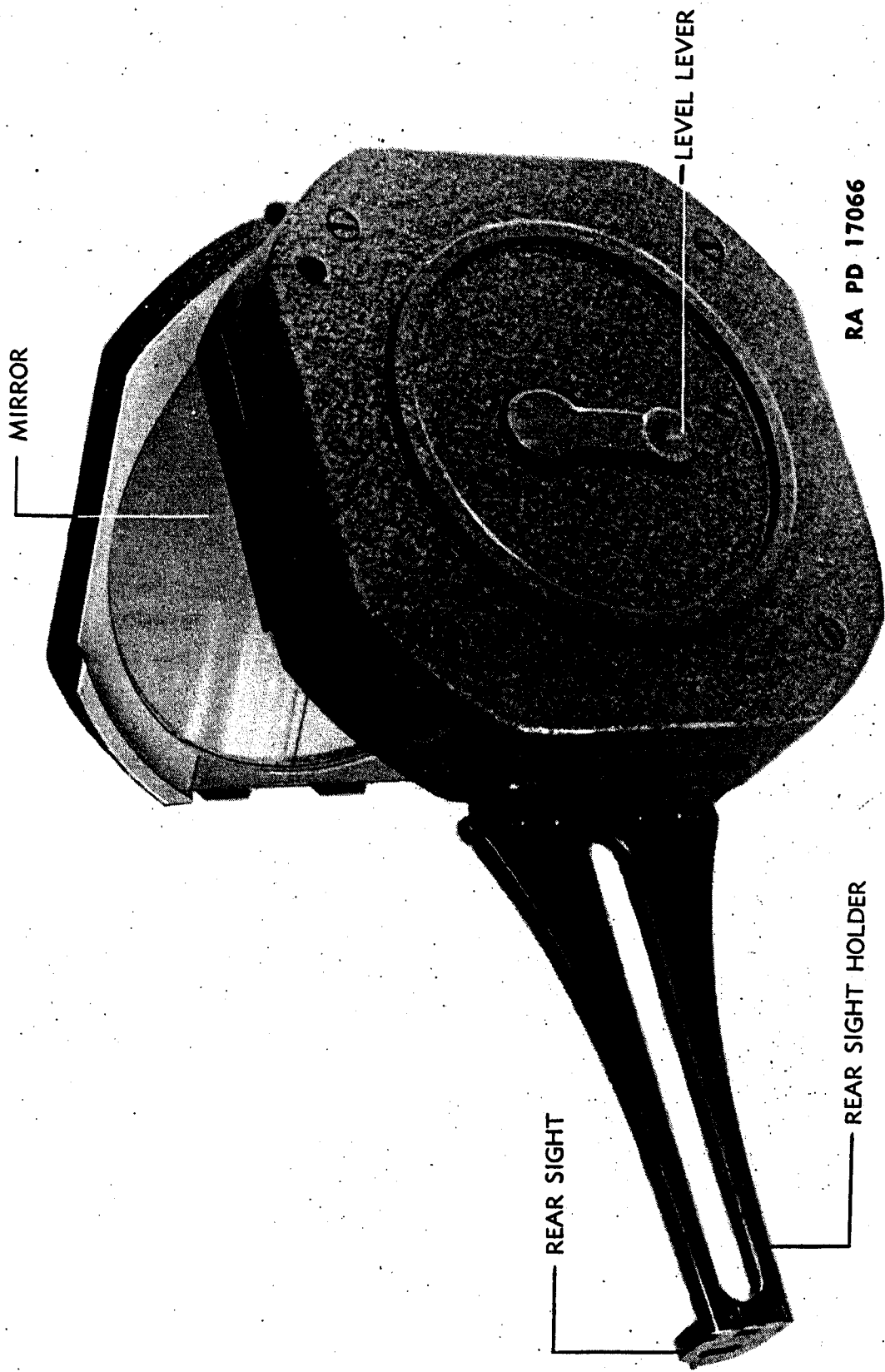

RA PD 17066

Figure 155—Compass, M2, side view, site

W  
(  
C  
10  
C  
E  
T  
A  
S  
r

ATIONS

**FIRE-CONTROL EQUIPMENT**

weather, wipe the compass dry before placing it in the carrying case.

(b) When the instrument is moved from one position to another, or is not in use, close the cover, locking the needle off its pivot. This prevents injury to the needle pivot.

(c) Particular care should be exercised to prevent bending the sights or the cover hinge. Lay the rear sight flat before closing the cover.

(d) Moisture due to condensation may collect in the instrument when the temperature of the parts is lower than that of the surrounding air. This moisture, if not excessive, can be removed by placing the instrument in a warm place.

(e) No lubrication is required.

**104. GRAPHICAL FIRING TABLES**

a. Graphical firing tables are used to simplify and speed up the conduct of fire, and to help reduce the probability of error. The graphical firing table consists of a graduated stock and slide to form a Mannheim-type slide rule. The range scale on the stock of the rule is plotted logarithmically. All of the scales are so plotted as to conform to this range scale. Graphical firing tables are made for each Field Artillery weapon, used for indirect fire, and are designated by model.

b. Graphical Firing Tables, M6 and M15. These are standard for use with the 155-mm Gun, M1917, M1918, and Modifications. The M6 is for ranges from 0 to 15,000 yards and the M15 is for ranges over 10,000 yards. Other information is not available at this time.

**105. HAND FUZE SETTER, M1913**

a. General. This fuze setter (fig. 156) is used for setting powder-train fuzes. It is furnished complete with carrying case. It is for use only with shrapnel.

b. Operation. (1) Check to see that the time scale and corrector scale correspond to the materiel and ammunition in use. The time scale is marked 45 SEC. COMB. FUZE and the corrector scale is marked 155-MM GUNS. The guide ring on the under side of the fuze setter is marked 155-MM GUN OR HOW.

(2) Pull out the detent knob, and while holding, rotate the range worm crank until the desired setting is indicated on the time scale, then release the knob.

(3) Rotate the corrector worm knob until the desired corrector is

RA PD 17066

Figure 155—Compass, M2, side view, site

## 155-MM GUN MATERIEL, M1917, M1918 AND MODIFICATIONS

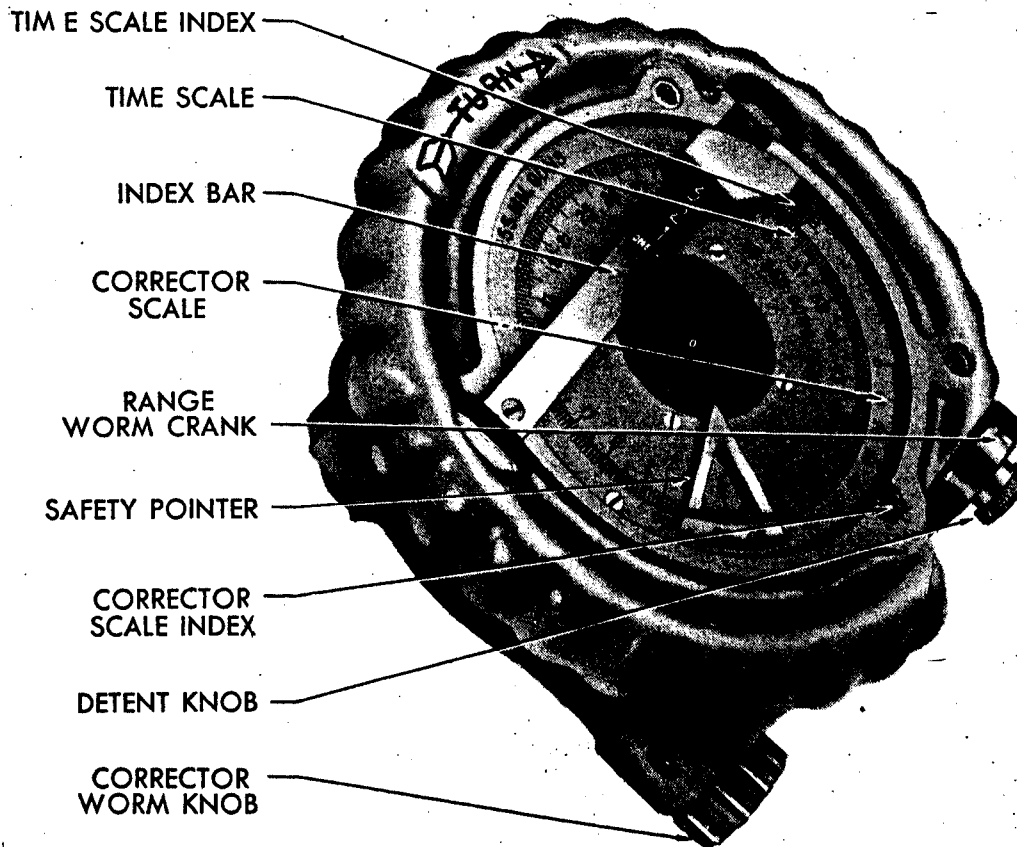

RA PD 37675

*Figure 156—Hand fuze setter, M1913, for use only with shrapnel*

indicated on the corrector scale. If no corrector is desired, make this setting at the "30" graduation (marked by arrow).

(4) Place the fuze setter over the point of the fuze, and rotate the fuze setter in a clockwise direction, as indicated by the arrow on the case, until the rotating pin on the fuze enters the slot in the setting ring. Press the fuze setter firmly onto the fuze and continue rotation until a stop is encountered, which indicates that the setting operation has been completed.

(5) Verify the fuze setting by noting that the safety pointer coincides with the line on the closing cap of the fuze.

(6) Lift off the fuze setter without rotating it.

(7) Rotate the fuze setter only in a clockwise direction. Incorrect settings and loosening of the fuze from the projectile may result from failure to follow these instructions.

c. **Tests and adjustments.** The accuracy of the fuze setter may be verified by comparing the values of range, indicated on the range scale, with those actually set on the fuze, at several different ranges. A corrector may then be applied to minimize the error. No other adjustment by the using arm is permitted.

FIRE-CONTROL EQUIPMENT

d. Care and preservation. (1) Refer to paragraph 93 for general instructions pertaining to the care and preservation of instruments.

(2) Occasionally, oil the range worm through the oil hole in the side of the case. This hole is normally plugged by a round head screw which should be removed for oiling and replaced immediately thereafter.

(3) Oil the corrector worm occasionally through the oil hole in the guide ring. This hole is located directly below the worm and is normally plugged by a guide ring retaining screw, which should be removed for oiling, and replaced immediately thereafter.

(4) When turning the range worm crank, withdraw the detent knob sufficiently to prevent scraping of the detent on the ratchet teeth. Scraping will eventually wear the detent to such an extent as to permit accidental turning of the crank.

(5) Do not lay or drop the fuze setter on the ground. Setters which become clogged with dirt will be turned in to ordnance personnel for repair.

(6) Keep the fuze setter in the carrying case when not in use.

106. B.C. TELESCOPE, M1915A1

a. General. The battery commander's telescope (figs. 157 and 158) is a 10-power binocular instrument used for observation and for measurement of azimuth and angle of site. It is furnished complete with mount and tripod, and the necessary carrying cases, storage chest, and cleaning brushes.

b. Description. (1) The telescopes are arranged so that they may be positioned vertically, (fig. 157), or swung down horizontally so as to provide an accentuated stereoscopic effect (fig. 158).

(2) Modified instruments, designated M1915A1, are equipped for reticle illumination and are designed to receive the instrument light M1. Illumination for such instruments may be supplied by flash-light until such time as the instrument light becomes available. Unmodified instruments are designated M1915.

c. Operation. (1) To set up the instrument, remove the tripod and mount from the tripod carrying case, clamp the tripod legs at the desired length, embed them firmly in the ground, and tighten the leg clamping levers. Remove the telescope from its carrying case. Place it on the vertical spindle extending from the mount, depressing the locking plunger and turning the telescope until the mating surfaces of telescope and mount engage properly, then releasing the plunger. Level the mount, using the circular level and the ball-and-socket joint at the

FICATIONS

D 37675

el

ake this

d rotate  
v on the  
ng ring.  
until a  
as been

pointer

orrect  
from

setter  
the  
erent  
No



155-MM GUN MATERIEL, M1917, M1918 AND MODIFICATIONS

bottom of the mount, and clamp with the lever when the level bubble is centered.

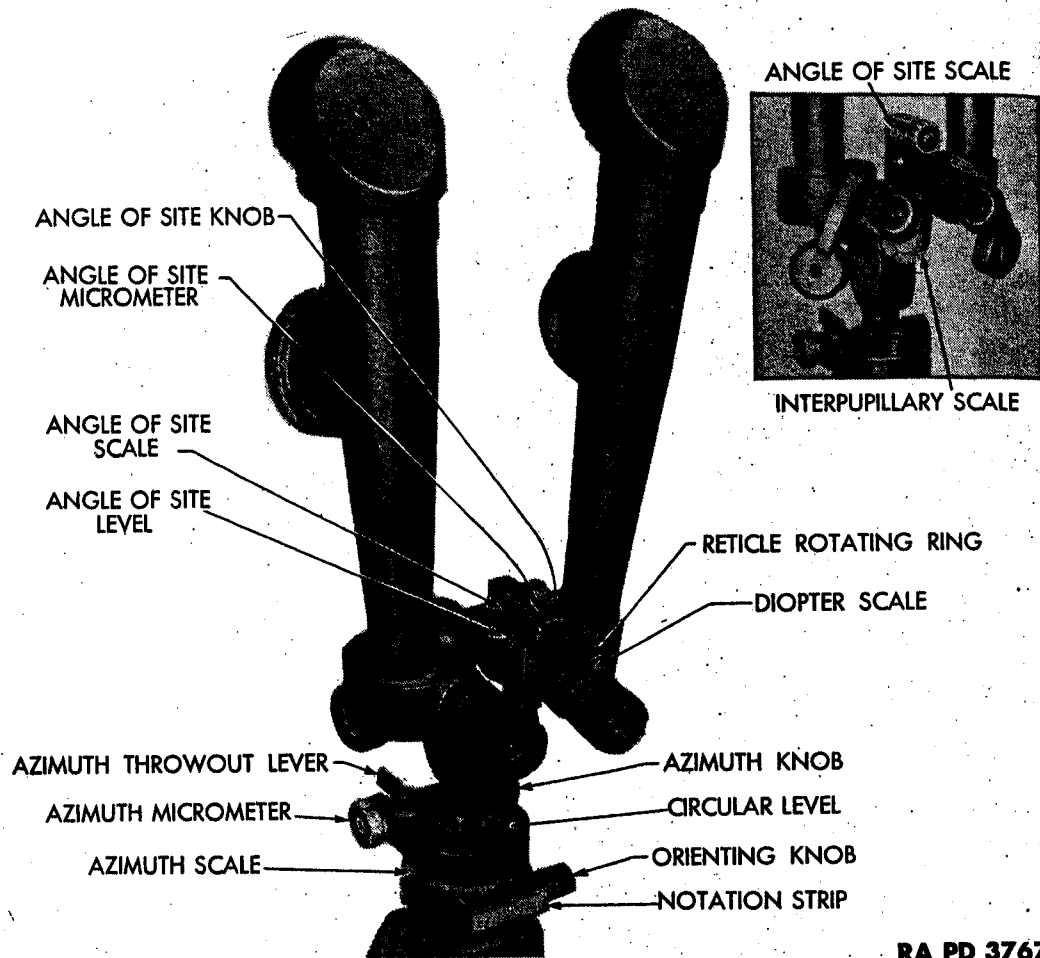

RA PD 37676

Figure 157—Rear view of battery commander's telescope, M1915, with telescopes positioned vertically

(2) To prepare the telescope, remove the caps from the eyepieces and objectives. If required, place the sunshades over the objectives and the amber filters over the eyelenses. Sunshades and filters are carried in compartments of the telescope case. Release the telescope clamping knob and turn the telescopes to the vertical or horizontal position as required, at the same time setting the proper interpupillary distance in millimeters on the associated scale, and clamp in place. If the interpupillary distance for the observer is not known, it may be found by observing the sky and moving the eyepieces apart or together until the field of view changes from two overlapping circles to one sharply defined circle. Focus each eyepiece independently, looking through the telescope with both eyes open, at an object several hundred yards away, covering the front of one telescope and turning the diopter scale until the object appears sharply defined, then repeating for the other eye. A diopter scale is provided for each eye, and if the observer remembers the values

## FIRE-CONTROL EQUIPMENT

for his own eyes, the setting may be made directly on the scales. Turn the reticle rotating ring until the reticle appears erect.

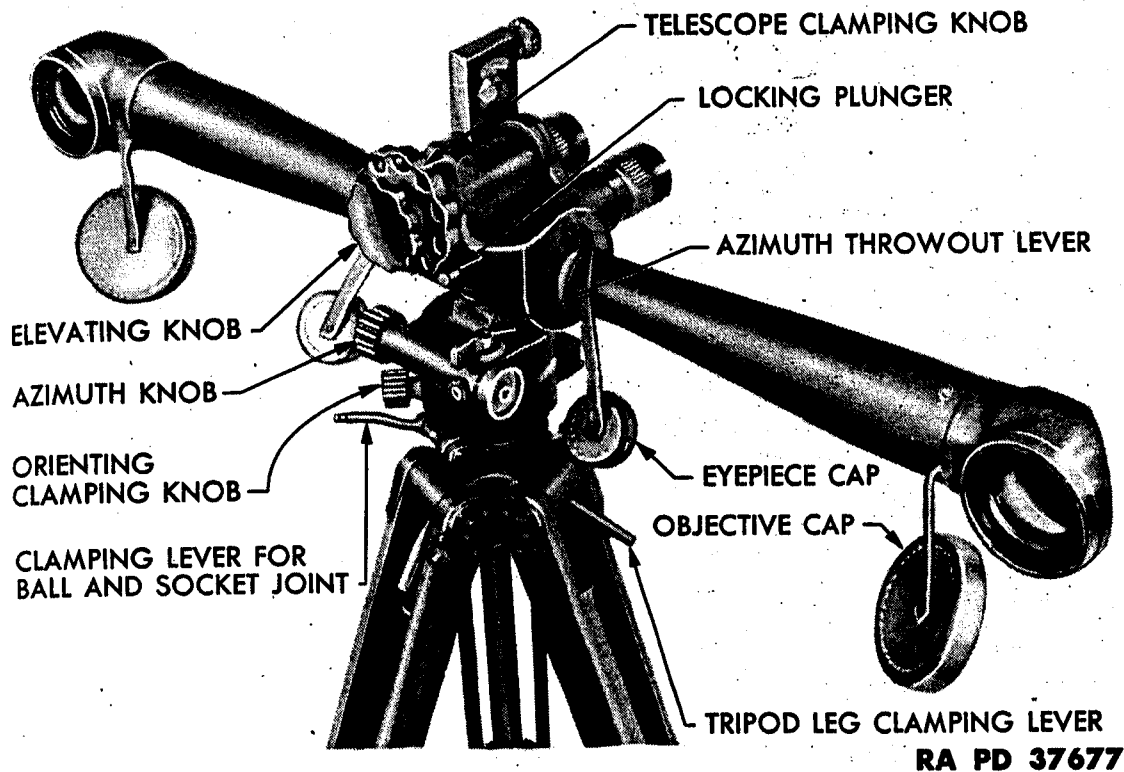

RA PD 37677

**Figure 158—Front view of battery commander's telescope, M1915, with telescopes swung down horizontally to provide an accentuated stereoscopic effect**

(3) To orient the instrument, select a datum point of known azimuth and set this value on the azimuth scale (100-mil steps) and micrometer (1-mil steps). The throwout lever may be used to disengage the worm drive for making large changes in azimuth rapidly. Turn the telescope by means of the orienting knob until the datum point appears at the center of the reticle of the right-hand telescope. The orienting clamping knob may be temporarily released for making large angular changes rapidly. Thereafter, use only the azimuth knob or, for large changes, the azimuth throwout lever, and the correct azimuth of the point observed will be indicated. For azimuths in the 3200-6400 mil region, additional numbers (0-3200 mils) are provided, corresponding to the azimuth scales on panoramic telescopes and other instruments used by field artillery organizations.

(4) To read angle of site, swing the angle of site mechanism into a substantially vertical plane. Direct the telescope on the object and rotate the elevating knob until the object appears at the center of the reticle. By means of the angle of site knob, center the bubble of the angle of site level in its vial. The angle of site is then read on the angle of site

**155-MM GUN MATERIEL, M1917, M1918 AND MODIFICATIONS**

scale (100-mil steps) and micrometer (1-mil steps). An indication of 300 mils corresponds to a horizontal line of sight.

(5) Angular indications are on the reticle. The horizontal axis of the reticle is graduated at 5-mil intervals for 30 mils on each side of the center. The two short lines above the horizontal line are spaced three mils apart.

(6) To prepare the instrument for traveling, remove the sunshades and filters, if used, and place them in the pockets of the telescope carrying case. Cover the objectives and eyepieces. With the telescope shanks in a vertical position, press the locking plunger and lift the telescope from the mount. Loosen the telescope clamping knob and swing the elevating mechanism against the right-or left-hand telescope. The instrument will then fit snugly into the blocking of the case. The mount need not be removed from the tripod. Tripod leg clamping levers should not protrude.

d. Tests and adjustments. (1) The azimuth micrometer and azimuth scale should read zero simultaneously. The screw in the end of the micrometer may be temporarily loosened to permit slipping the micrometer to the desired position.

(2) The angle of site mechanism may be checked by observing a datum point of known angle of site. Small errors may be corrected by temporarily loosening the screw in the end of the knob and slipping the micrometer and knob to the correct position. Should the angle of site scale and micrometer then fail to indicate 3 and 0, respectively, simultaneously, the instrument should be turned in for adjustment by authorized ordnance personnel.

(3) The ball-and-socket joint of the mount should have a snug friction fit when the associated clamping lever is released. Excessive tightness or lost motion may be adjusted by means of the plug in the center of the bottom of the mount. This plug is locked by the retaining ring concentric therewith, which must be loosened for adjusting; tighten the retaining ring securely when adjustment is completed.

e. Care and preservation. (1) Refer to paragraph 93 for general instructions pertaining to the care and preservation of instruments.

(2) Exposed moving parts should be oiled occasionally. Interior parts are not to be lubricated by the using arm. Keep excess lubricant, that seeps from the mechanisms, wiped off to prevent accumulation of dust and grit.

G  
N  
F  
C  
I  
(



### Section XIII AMMUNITION

	Paragraph
General.....	107
Nomenclature.....	108
Firing tables.....	109
Classification.....	110
Identification and marking.....	111
Care, handling and preservation.....	112
Authorized rounds.....	113
List of authorized rounds (Table 1).....	<b>Page 188</b>
Preparation for firing.....	114
Projectiles.....	115
Characteristics of projectiles (Table 2).....	<b>Page 192</b>
Propelling charges.....	116
Fuzes.....	117
Primers.....	118
Packing.....	119
Field report of accidents.....	120

#### 107. GENERAL

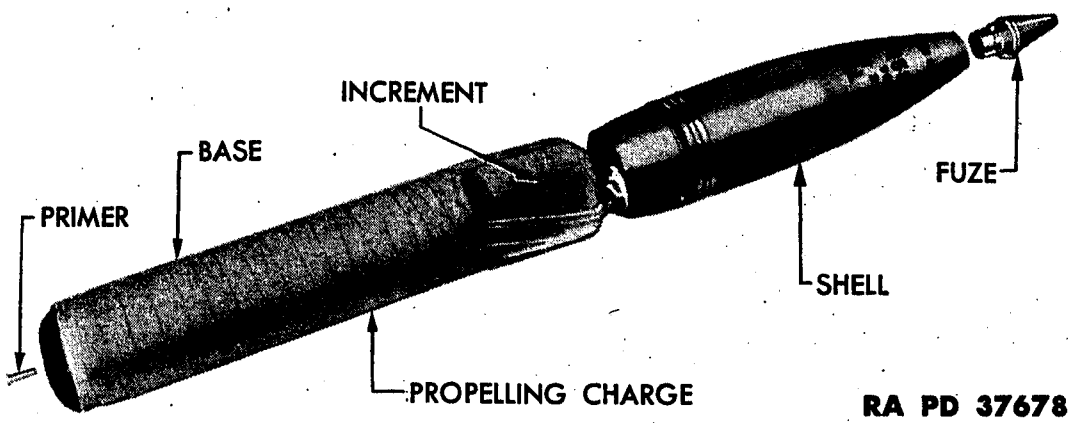

RA PD 37678

**Figure 159—The components of a supercharge round of ammunition for the 155-mm guns, M1917, M1917A1 and M1918MI—the PRIMER, percussion, 21-grain, Mk. IIA1; the CHARGE, propelling, NH powder; the SHELL, H.E. M101; and the FUZE, P.D., M51A1, w/BOOSTER, M21A1. For normal charge, the increment is removed**

The 155-mm guns, M1917, M1917A1 and M1918MI, being chambered alike, fire the same ammunition. The ammunition is of the separate loading type. The loading of a complete round requires three operations: loading the projectile, loading the propelling charge, and inserting the

## 155-MM GUN MATERIEL, M1917, M1918 AND MODIFICATIONS

primer. The components of a complete round—fuze, projectile, propelling charge, and primer (fig. 159)—are shipped separately. The fuze is assembled to the projectile just prior to firing.

### 108. NOMENCLATURE

Standard nomenclature is used in this section in reference to specific items of issue.

### 109. FIRING TABLES

For applicable firing tables, see "Reference" Section of this manual.

### 110. CLASSIFICATION

a. General. Dependent upon the type of projectile, ammunition for the 155-mm guns, M1917, M1917A1 and M1918MI, is classified as high explosive, armor piercing, chemical, shrapnel, practice and dummy.

b. High explosive shell are filled with a high explosive bursting charge.

c. Armor-piercing projectiles are thick-walled shell containing a small amount of high explosive. They are used for penetrating armor plate.

d. Chemical shell contain a chemical filler which produces either a toxic or irritating physiological effect, or a screening smoke an incendiary action or a combination of these.

e. Shrapnel contains a small amount of low explosive filler and are designed to carry a large number of spherical shot to a distance from the gun, and there discharge them over an extended area.

f. Target-practice projectiles are cast-iron, or sand-loaded shell of the same size, shape and weight as service shell. Some models contain a smoke puff charge while others are completely inert.

g. Dummy ammunition, which is completely inert, is provided for practice in loading and handling and service of the piece.

### 111. IDENTIFICATION AND MARKING

a. General. Ammunition, including components, is completely identified by means of painting and marking. Other essential information such as weight zone and muzzle velocity, may also be obtained from firing tables.

b. Mark or model. (1) To identify a particular design, model numbers are assigned at the time the design is classified as an adopted type. This model designation becomes an essential part of the standard nomenclature and is included in the marking on the item.

AMMUNITION

(2) The present method of model designation consists of the letter "M" followed by an Arabic numeral. Modifications are indicated by adding the letter "A" and appropriate Arabic numerals. Thus, M43A1 is the first modification of an item for which the original designation was M43.

Prior to July 1, 1925, it was the practice to assign mark numbers. The word "mark" abbreviated Mk. was followed by a Roman numeral, for example: SHELL, HE, Mk. III. The first modification of a model was indicated by the addition of MI to the mark number, the second by MII, etc. Ammunition assigned mark numbers originally have been given modification designations conforming to the current nomenclature, for example: SHELL, HS, Mk. VIIA1.

(4) Earlier still, the year of adoption, preceded by the letter M, was used as the model designation.

c. Ammunition lot number. (1) When the ammunition is manufactured, an ammunition lot number, which becomes an essential part of the marking, is assigned in accordance with pertinent specifications. In the case of separate loading ammunition, such a lot number is assigned and marked on each of the components—projectile, fuze, propelling charge, and primer—as well as on all packing containers. It is required for all purposes of record.

(2) To provide for the most uniform functioning, all of the components in any one lot are manufactured under as nearly identical conditions as practicable. For example, in the case of projectiles, any one lot consists of projectiles made by one manufacturer, loaded by one manufacturer, and of one weight zone. Therefore, to obtain the greatest accuracy, when firing separate loading ammunition, successive rounds should consist of projectiles of one lot number, propelling charges of one lot number, fuzes of one lot number, and primers of one lot number.

d. Painting and marking. (1) All projectiles are painted to prevent rust and, by the color, to provide a ready means for identification as to type. The color scheme is as follows:

- High explosive..... Yellow, marking in black.
- Armor-piercing (with explosive filler)..... Yellow, marking in black.
- Chemical..... Gray, one green band indicates non-persistent gas; two green bands, persistent gas; one yellow band, smoke. Marking in the same color as the band or bands.
- Shrapnel..... Red, marking in black.
- Practice..... Blue, marking in white.
- Drill..... Black, marking in white.

**155-MM GUN MATERIEL, M1917, M1918 AND MODIFICATIONS**

(2) For purposes of identification, components of separate loading ammunition are marked as follows:

On the projectile, except shrapnel:

- Caliber and type of cannon in which fired.
- Kind of filler, for example, TNT, CN GAS, etc.
- Mark or model of projectile.
- Weight zone marking.
- Lot number.

(The only marking on shrapnel is that of caliber and type of cannon in which fired; the lot number is stamped on the rotating band.)

On the propelling charge:

- Designation of section—"Base" on base section, "Increment" on increment section.
- Powder lot number.
- Caliber and type of cannon in which fired.
- Weight of igniter charge.

On the fuze (stamped on body):

- Type and model of fuze.
- Loader's initials.
- Month and year loaded.
- Loader's lot number.

On the primer (stamped on head):

- Initials of loader.
- Loader's lot number.
- Year of loading.
- Mark number.

e. **Weight zone markings.** (1) Because it is not practicable to manufacture projectiles within the narrow limits required for the desired accuracy of fire, they are grouped into weight zones so that appropriate ballistic corrections given in the firing tables may be applied.

(2) The weight zone of the projectile is indicated thereon by squares of the same color as the original markings, with a prick punch in the center of each. There are one, two, three, four or more squares, dependent upon the weight of the projectile. For 155-mm projectiles, four squares with punch marks indicate normal weight.

(3) When manufactured, shrapnel is adjusted to standard weight by the addition of more or fewer shrapnel balls. It, therefore, requires no weight zone markings.

**112. CARE, HANDLING AND PRESERVATION**

a. Ammunition components are packed to withstand conditions, ordinarily encountered in the field, and are shipped separately. All

## AMMUNITION

155-mm gun unfuzed projectiles (except shrapnel) are fitted with an eyebolt lifting plug and a grommet, which protects the rotating band. Therefore, a shipping crate is not required. Shrapnel are shipped in packing boxes. Fuzes, charges and primers are packed in moisture-resistant containers. Since explosives are adversely affected by moisture and high temperatures, due consideration should be given to the following:

(1) Do not break the moisture-resistant seal until the ammunition is to be used.

(2) Protect ammunition, particularly fuzes, primers and propelling charges from high temperature, including direct rays of the sun. More uniform firing is obtained if the rounds, especially the propelling charges, are at the same temperature.

b. Do not attempt to disassemble any fuze.

c. Before loading, each of the separate loading components should be free of sand, mud, moisture, grease or other foreign matter.

d. Do not remove protective or safety devices from fuzes until just before use.

e. Explosive ammunition, or components containing explosive, must be handled with appropriate care at all times. The explosive elements in primers and fuzes are particularly sensitive to undue shock and high temperature.

f. Do not remove the eyebolt lifting plug from unfuzed projectiles until the fuze is to be assembled thereto. The eyebolt lifting plug is provided for convenience in handling and to keep the fuze opening free of foreign matter.

g. Primers must always be stored in a dry place. Prolonged exposure to moisture or dampness may cause malfunctioning.

h. Components of rounds prepared for firing, but not fired, will be returned to their original condition and packings and appropriately marked. Fuzes will be inspected prior to repacking. All such components will be used first in subsequent firings, in order that stocks of opened packings may be kept at a minimum.

### 113. AUTHORIZED ROUNDS

Being chambered alike, the 155-mm guns, M1917, M1917A1 and M1918MI, fire the same ammunition. The ammunition authorized for use in these guns is described on the following pages. Authorized rounds are listed in Table No. 1, pages 188 and 189. The nomenclature completely identifies the ammunition.

## 155-MM GUN MATERIEL, M1917, M1918 AND MODIFICATIONS

TABLE 1

## AUTHORIZED ROUNDS

AMMUNITION FOR THE 155-MM GUNS,  
M1917, M1917A1 AND M1918MI\*

\*In addition to the components shown, one primer is required for each full round of separate loading ammunition

Nomenclature of Projectile	Fuze		Propelling Charge Type
	Type and Model	Action	
<b>SERVICE AMMUNITION:<sup>3*</sup></b>			
PROJECTILE, A.P., M112, w/FUZE, B. D., M60, 155-mm guns, M1917-17A1-18MI, M1, and M1A1	B.D. M60	Delay	Base and Increment <sup>1</sup>
SHELL, gas, persistent, HS, M104, unfuzed, 155-mm guns, M1917-17A1-18MI, M1, and M1A1 (adapted for FUZE, P.D., M51, w/BOOSTER, M21, or M51A1, w/BOOSTER, M21A1)	P.D. M51A1, w/BOOSTER, M21A1	S.Q. and delay	Base and Increment <sup>1</sup>
SHELL, gas, persistent, HS, Mk. VIIA1, unfuzed, 155-mm guns, M1917-17A1-18MI (adapted for FUZE, P.D., M51, w/BOOSTER, M21 or M51A1, w/BOOSTER, M21A1)	P.D. M51A1, w/BOOSTER, M21A1	S.Q. and delay	Base and Increment <sup>1</sup>
SHELL, H.E., M101, unfuzed, 155-mm guns, M1917-17A1-18MI, M1, and M1A1 (adapted for FUZE, P.D., M51, w/BOOSTER, M21, or M51A1, w/BOOSTER, M21A1; or FUZE, time mechanical, M67, w/BOOSTER, M21A1)	P.D. M51A1, w/BOOSTER, M21A1 or Mech. time, M67, w/BOOSTER, M21A1	S.Q. and delay  Time	Base and Increment <sup>1</sup>
SHELL, H.E., Mk. III, unfuzed, 155-mm guns, M1917-17A1-18MI (adapted for PDF M46, or M47)	P.D. M46 or P.D. M47	S.Q.  Delay	Base and Increment <sup>1</sup>
SHELL, H.E., Mk. IIIA1, unfuzed, 155-mm guns, M1917-17A1-18MI (adapted for FUZE, P.D., M51, w/BOOSTER, M21, or M51A1, w/BOOSTER, M21A1) or FUZE, time mechanical, M67; w/BOOSTER, M21A1)	P.D. M51A1, w/BOOSTER, M21A1 or Mech. time, M67, w/BOOSTER, M21A1	S.Q. and delay  Time	Base and Increment <sup>1</sup>
SHELL, smoke, FS, M104, unfuzed, 155-mm guns, M1917-17A1-18MI, M1, M1A1 (adapted for FUZE, P.D., M51, w/BOOSTER, M21, or M51A1, w/BOOSTER, M21A1)	P.D. M51A1, w/BOOSTER, M21A1	S.Q. and delay	Base and Increment <sup>1</sup>
SHELL, smoke, FS, Mk. VIIA1, unfuzed, 155-mm guns, M1917-17A1-18MI (adapted for FUZE, P.D., M51, w/BOOSTER, M21, or M51A1, w/BOOSTER, M21A1)	P.D. M51A1, w/BOOSTER, M21A1	S.Q. and delay	Base and Increment <sup>1</sup>

AMMUNITION

TABLE 1 (continued)

AUTHORIZED ROUNDS

AMMUNITION FOR THE 155-MM GUNS,  
M1917, M1917A1 AND M1918MI\*

Propelling Charge Type	Nomenclature of Projectile	Fuze		Propelling Charge Type
		Type and Model	Action	
Base and Increment <sup>1</sup>	SHELL, smoke, phosphorus, WP, M104, 155-mm guns, M1917-17A1-18MI, M1, M1A1 (adapted for FUZE, P.D., M51, w/BOOSTER, M21, or M51A1, w/BOOSTER, M21A1)	P.D. M51A1, w/BOOSTER, M21A1	S.Q. and delay	Base and Increment <sup>1</sup>
Base and Increment <sup>1</sup>	SHELL, smoke, phosphorus, WP, Mk. VIIA1, 155-mm guns, M1917-17A1-18MI (adapted for FUZE, P.D., M51, w/BOOSTER, M21 or M51A1, w/BOOSTER, M21A1)	P.D. M51A1 w/BOOSTER, M21A1	S.Q. and delay	Base and Increment <sup>1</sup>
Base and Increment <sup>1</sup>	SHRAPNEL, Mk. I, fuzed, 155-mm gun, or how., M1917-17A1-18MI	M1907M	Time and percussion	Base and Increment <sup>1</sup>
Base and Increment <sup>1</sup>	PRACTICE AMMUNITION: <sup>3*</sup>			
Base and Increment <sup>1</sup>	SHELL, empty, for sand loading, 95-lb., Mk. III, unfuzed, 155-mm gun, M1917-17A1-18MI (adapted for inert PDF or M47)	P.D. M47 inert	None	Base and Increment <sup>1</sup>
Base and Increment <sup>1</sup>	DUMMY AMMUNITION: <sup>4*</sup>			
Base and Increment <sup>1</sup>	PROJECTILE, dummy, 95-lb., Mk. I, 155-mm guns, M1917-17A1-18MI	M1907M inert	None	Base and Increment <sup>2</sup>
Base and Increment <sup>1</sup>	SUBCALIBER AMMUNITION:			
Base and Increment <sup>1</sup>	SHELL, fixed, practice, Mk. II, w/FUZE, practice, M38), 37-mm gun, M1916	M38 Base practice	Impact	
Base and Increment <sup>1</sup>	SHELL, fixed, sand loaded, Mk. I, 100% service charge, 37-mm gun, M1916	Mk. I, Base percussion	Impact	

A.P.—Armor-piercing      B.D.—Base detonating      S.Q.—Superquick  
 H.E.—High explosive      P.D.—Point detonating      L.E.—Low explosive  
 PDF—Point detonating fuze

NOTES:

1—The service or practice charges are designated CHARGE, propelling, 155-mm guns, M1917-17A1-18MI, and CHARGE, propelling, NH powder, 155-mm guns, M1917-17A1-18MI.

2—The dummy charge is designated CHARGE, propelling, dummy, (21-lb. base with 5½-lb. increment), Mk. I, 155-mm guns, M1917-17A1-18MI.

3—The service or practice primer is designated PRIMER, percussion, 21-grain, Mk. IIA1.

4—A fired service primer is used with dummy ammunition for drill purposes.

## 155-MM GUN MATERIEL, M1917, M1918 AND MODIFICATIONS

## 114. PREPARATION FOR FIRING

Prior to loading, it is necessary to remove the grommet which protects the rotating band and to assemble the fuze to the projectile as described in the paragraph devoted to the particular fuze. Also, the igniter protector cap and the data tag must be removed from the propelling charge and the charge adjusted for the zone to be fired, as described in paragraph 111-e.

## 115. PROJECTILES

a. General. (1) Projectiles for 155-mm guns, except shrapnel, are of two general types: those of earlier design, distinguished by two narrow rotating bands, each approximately 6/10-inch wide, such as the SHELL H.E., Mk. III, unfuzed, 155-mm guns, M1917-17A1-18MI (fig. 161); and those of current design, distinguished by a broad rotating band, approximately two inches wide, such as the SHELL, H.E., M101, unfuzed, 155-mm guns M1917-17A1-18MI, M1 and M1A1 (fig. 160). Shrapnel have a rotating band approximately  $1\frac{1}{4}$  inches wide, see SHRAPNEL, Mk. I, fuzed (or unfuzed), 155-mm gun or how., M1917-17A1-18MI (fig. 163).

(2) Although projectiles for the 155-mm gun and the 155-mm howitzer are of the same size and shape, they are readily distinguished by the marking as well as by the rotating bands. The howitzer projectiles have one rotating band 6/10-inch wide; the gun projectiles have bands as described above.

b. Description. (1) The projectiles of current design are adapted for FUZE, P.D., M51, w/BOOSTER M21, (fig. 169), FUZE, P.D., M51A1 w/BOOSTER, M21A1, or FUZE, time, mechanical, M67, w/BOOSTER, M21A1, while those of earlier design as originally manufactured, are adapted for fuzes, such as the FUZE, P.D. M46 (fig. 167).

(2) In a recent modification, the adapter of the projectiles of earlier design has been changed to take the M51, M51A1 and M67 fuzes; thus both the projectiles of current design and those of earlier design, which have been modified, are adapted for these fuzes. For these projectiles, the booster is assembled to the fuzes as shipped, whereas in the projectiles of earlier design (unmodified), the booster is an integral part of the loaded projectile.

(3) Except for shrapnel and the armor-piercing model, all of these projectiles are provided with an ogival head of nearly 11 calibers and are "boat-tailed" (conical surface to the rear of the rotating band). Projectiles containing high explosive filler have base covers. The weight zone is included in the marking on each projectile as described in paragraph 111-e.



AMMUNITION

(4) Shrapnel for these 155-mm guns has a "square base," that is, a cylindrical surface to rear of rotating band. It is authorized for use in either the howitzers, M1917, M1917A1 or M1918, or the guns, M1917, M1917A1 or M1918MI—not the guns M1 and M1A1, nor the howitzer, M1.

THE CHARACTERISTICS OF THE PROJECTILES FOR THE 155-MM GUNS, M1917, M1917A1 AND M1918MI, ARE GIVEN IN TABLE 2 ON PAGES 192 AND 193.

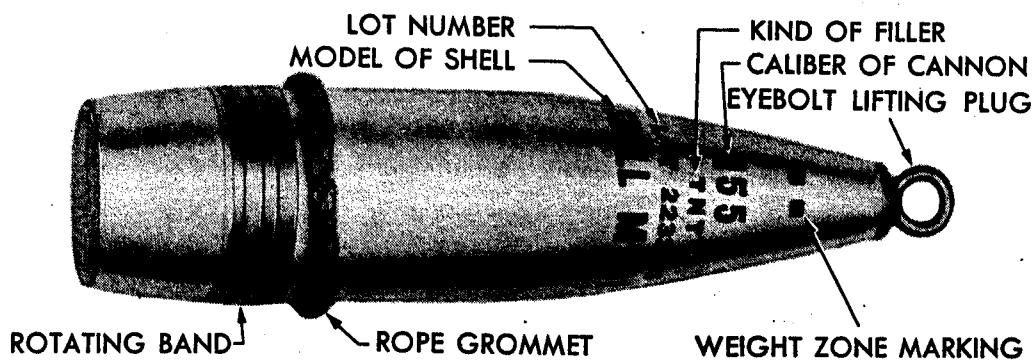

RA PD 37679

Figure 160—SHELL, H.E. M101, unfuzed, 155-mm guns, M1917-17A1-18MI, M1, M1A1 (adapted for FUZE, P.D., M51, w/BOOSTER, M21, or FUZE, P.D., M51A1, w/BOOSTER, M21A1; or FUZE, time, mechanical, M67, w/BOOSTER, M21A1)

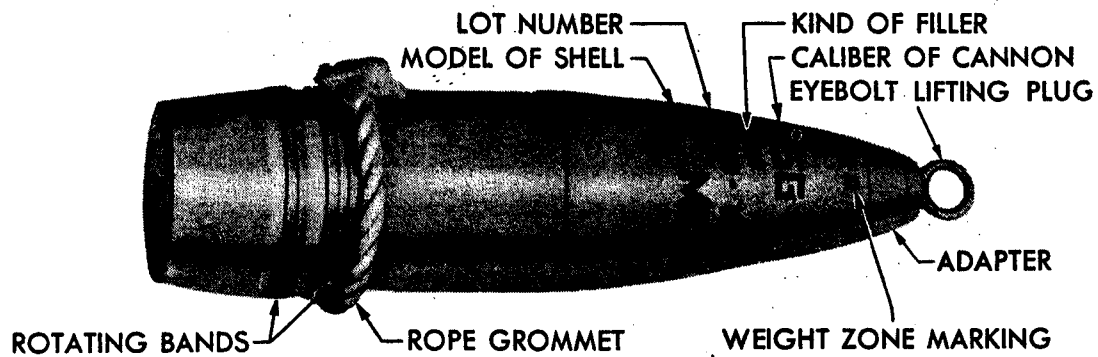

RA PD 37681

Figure 161—SHELL, H.E., Mk. III, unfuzed, 155-mm guns, M1917-17A1-18MI (adapted for PDF, M46, or 47). Note that this shell has two narrow rotating bands

155-MM GUN MATERIEL, M1917, M1918 AND MODIFICATIONS

TABLE 2

CHARACTERISTICS OF PROJECTILES FOR

Line No.	Type	Model	Length of Shell	Ship. Wt. lbs.	Shape		Rotating Band	Filler	
					Point	Base		Weight lbs.	Type
<b>SERVICE AMMUNITION</b>									
1	A. P.	M112	23.62 max.	109	Wind-shield	Square	2 in.	1.44	Explosive D
2	Gas	M104	26.78 max.	95	Ogive	Boat tail 8.5° taper	2 in.	11.70 0.66	HS Burstler expl.
3	Gas	Mk. VIIA1	26.82 max.	95	Ogive	Boat tail 8° taper	2 in.	11.40 0.59	HS Burstler expl.
4	H. E. (See fig. 160)	M101	26.79 max.	95	Ogive	Boat tail 8.5° taper	2.02 in.	16. or 14.78 or 14.05	TNT AM. 50-50 AM. 80-20
5	H. E. (See fig. 161)	Mk. III	25.54 max.	95	Ogive	Boat tail 8° taper	Two .59 in. ea.	15. or 14.2 or 13.25	TNT AM. 50-50 AM. 80-20
6 <sup>x</sup>	H. E. (See fig. 162)	Mk. IIIA1	26.88 max.	96	Ogive	Boat tail 8° taper	Two .59 in. ea.	15. or 14.41 or 13.35	TNT AM. 50-50 AM. 80-20
7	Smoke	M104	26.78 max.	99	Ogive	Boat tail 8.5° taper	2 in.	16.9 0.66	FS Burstler expl.
8	Smoke	Mk. VIIA1	26.82 max.	100	Ogive	Boat tail 8° taper	2 in.	16. 0.59	FS Burstler expl.
9	Smoke Phos.	M104	26.78 max.	98	Ogive	Boat tail 8.5° taper	2 in.	16. 0.66	WP Burstler expl.
10	Smoke Phos.	Mk. VIIA1	26.82 max.	98	Ogive	Boat tail 8° taper	2 in.	15. 0.59	WP Burstler expl.
11	Shrap- nel (See fig. 163)	Mk. I	18.83 max.		Ogive	Square base	1.27 in.	33.89 1.21	800 shrap. balls Blk. pdr.
<b>SUBCALIBER AMMUNITION—37-MM SUBCALIBER GUN, M1916</b>									
12	Shell, fixed, practice	Mk. II (See fig. 165)	6.92 max.		Ogive			0.059	Blk. pdr.
13	Shell, fixed, sand loaded	Mk. I (See note #1)	6.37		Ogive				Inert
<b>PRACTICE AMMUNITION</b>									
14	Shell, empty	Mk. III	25.54 max.	Load to 95	Ogive	Boat tail 8° taper	One or two		Sand loaded to weigh about 95 lb.
<b>DUMMY AMMUNITION</b>									
15	Dummy (See fig. 164)	Mk. I	21.14		Ogive				Inert

Note #1—100% service charge, issued for training to batteries having 37-mm subcaliber guns which fire over water.

115  
**AMMUNITION**

**TABLE 2 (continued)**

**155-MM GUNS, M1917, M1917A1, M1918MI**

		FUZE			SHIPPED		Line No.
er	Model	Type	Action				
Type	SERVICE AMMUNITION						
	M60	Base Detonating	Delay	Fuzed	Crated		1
Explosive D	M51, w/booster, M21; or M51A1, w/booster, M21A1	Point Detonating	Superquick and Delay	Unfuzed	Grommet	Eyebolt lifting plug	2
HS Hurster expl.	M51, w/booster, M21; or M51A1, w/booster, M21A1	Point Detonating	Superquick and Delay	Unfuzed	Grommet	Eyebolt lifting plug	3
HS Hurster expl.	M51, w/booster, M21; or M51A1, w/booster, M21A1; or M67, w/booster, M21A1	Point Detonating Mech. Time	Superquick and Delay Time	Unfuzed	Grommet	Eyebolt lifting plug	4
TNT I. 50-50 I. 80-20	M46, or M47	Point Detonating	Superquick Delay	Unfuzed	Grommet	Eyebolt lifting plug	5
FNT . 50-50 . 80-20	M51, w/booster, M21; or M51A1, w/booster, M21A1; or M67, w/booster, M21A1	Point Detonating Mech. Time	Superquick and Delay Time	Unfuzed	Grommet	Eyebolt lifting plug	6
NT . 50-50 . 80-20	M51, w/booster, M21; or M51A1, w/booster, M21A1	Point Detonating	Superquick and Delay	Unfuzed	Grommet	Eyebolt lifting plug	7
FS Hurster expl.	M51, w/booster, M21; or M51A1, w/booster, M21A1	Point Detonating	Superquick and Delay	Unfuzed	Grommet	Eyebolt lifting plug	8
FS Hurster pl.	M51, w/booster, M21; or M51A1, w/booster, M21A1	Point Detonating	Superquick and Delay	Unfuzed	Grommet	Eyebolt lifting plug	9
P Hurster pl.	M51, w/booster, M21; or M51A1, w/booster, M21A1	Point Detonating	Superquick and Delay	Unfuzed	Grommet	Eyebolt lifting plug	10
P Hurster pl.	M1907, or M1914, or Mk. I	45-sec. Combination	Percussion and Time	Fuzed (See note #2)	2 per box		11
rap. s dr.	<b>SUBCALIBER AMMUNITION—37-MM SUBCALIBER GUN, M1916</b>						
dr.	M38	Base Detonating	Percussion practice filler	Fuzed	60 per box, domestic shipment only		12
	Mk. I	Base Percussion	Percussion	Fuzed	60 per box, without metal liner, domestic shipment		13
	<b>PRACTICE AMMUNITION</b>						
	M46 or M47 Inert	Inert	None	Unfuzed	Grommet	Eyebolt lifting plug	14
	<b>DUMMY AMMUNITION</b>						
	M1907M	Inert	None	Fuzed	One per crate		15

Note #2—During peacetime, shrapnel is shipped unfuzed.

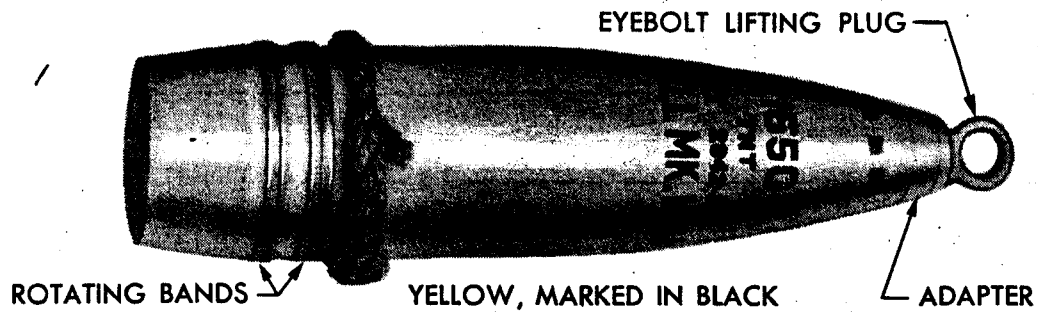

RA PD 37680

Figure 162—SHELL, H.E., Mk. IIIA1, unfuzed, 155-mm guns, M1917-17A1-18MI (adapted for FUZE, P.D., M51, w/BOOSTER, M21, or M51A1, w/BOOSTER, M21A1; or FUZE, time, mechanical, M67, w/BOOSTER, M21A1). This is a modification of the Mk. III shell with an adapter for the FUZE, P.D., M51, w/BOOSTER, M21

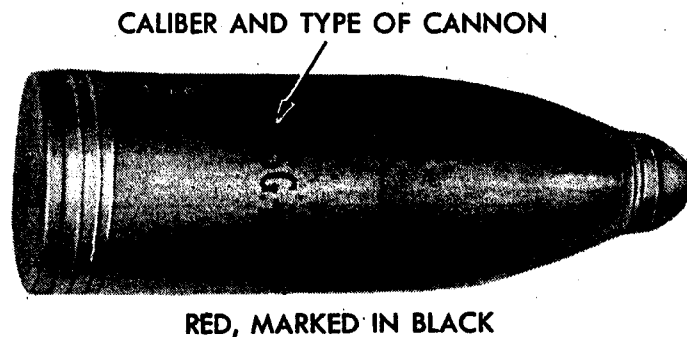

RA PD 37682

Figure 163—SHRAPNEL, Mk. I, fuzed or unfuzed (shown fuzed with fuze protector cap), 155-mm gun or how., M1917-17A1-18MI

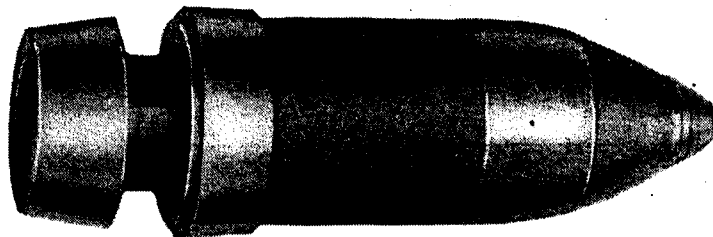

RA PD 37684

Figure 164—PROJECTILE, dummy, 95-pound, Mk. I, 155-mm guns, M1917-17A1-18MI. Inert FUZE, combination, 45-sec., M1907M. Provided for practice in loading and handling

## AMMUNITION

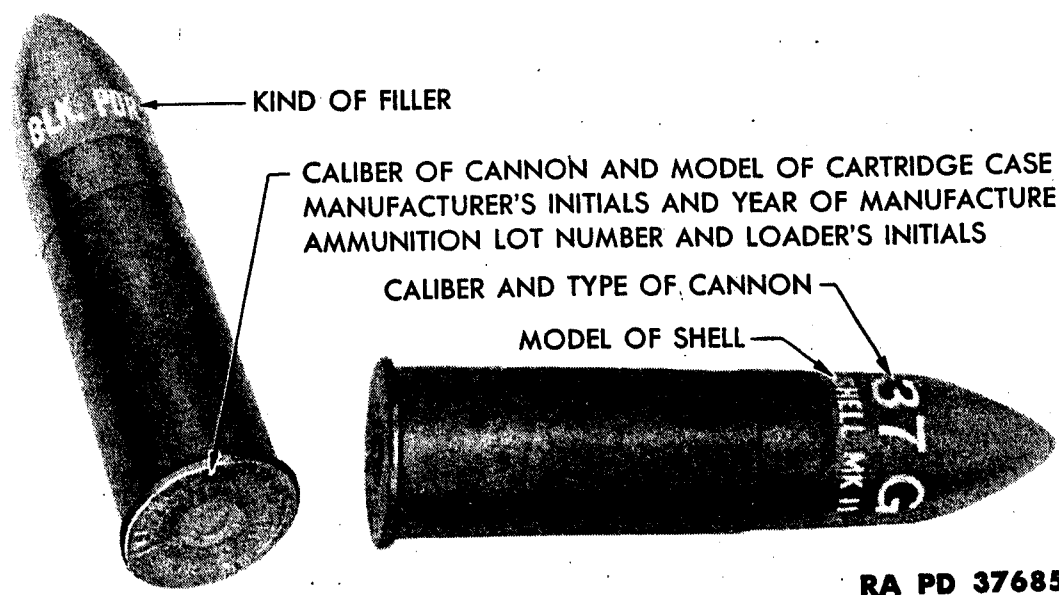

Figure 165—SHELL, fixed, practice, Mk. II, w/FUZE, practice, M38, 37-mm gun, M1916. This ammunition is issued in the form of fixed complete rounds, for use in subcaliber gun

## 116. PROPELLING CHARGES

a. General. (1) The propelling charge for the 155-mm guns, M1917, M1917A1 and M1918MI, is of the base and increment type, approximately six inches in diameter by 37 inches long, over-all. The base section is 28½ inches long; the increment section, 8½ inches.

The charge consists of smokeless powder in wrapped cloth bags and weighs approximately 26 pounds—20 pounds for the base section and six pounds for the increment section.

(2) An igniter, containing an igniter charge of 8 ounces of black powder, is sewed to the rear end of the base section. On charges of current manufacture, the igniter is dyed red to indicate that it contains black powder. On charges of earlier manufacture, the igniter may be identified by the word "igniter" stenciled thereon. The increment section is attached to the base section by means of four tying straps.

(3) The following identifying markings are stenciled on the charge.

## ON BASE SECTION

Rear End

IGNITER

8 OZ. GR. A-1

BLK. PDR. LOT XXX

155 MM.G.

XXX

Front End

BASE

PDR. LOT XXX

155 MM.G.

155-MM GUN MATERIEL, M1917, M1918 AND MODIFICATIONS  
ON INCREMENT SECTION

Rear End

Front End

Unmarked

INCREMENT

PDR. LOT XXX

155 MM.G.

(4) The full charge (base and increment) is known as the supercharge and is used only for extreme ranges. The base section only (increment section removed) is known as the normal charge, and is used for all ranges up to the maximum obtainable with it. An igniter protector cap is placed over the igniter to protect it during shipment.

b. Preparation for firing. When firing the supercharge, it is only necessary to remove the igniter protector cap prior to loading. When firing the normal charge, in addition to removing the igniter protector cap, it is also necessary to untie or cut the tying straps and remove the increment section.

**CAUTION:** When loading the charge, be sure that the igniter is to the rear (breach end). If the charge is loaded with the igniter end forward (toward the muzzle), the charge will not burn properly and might cause a serious accident should a hangfire occur.

c. CHARGE, PROPELLING, NH POWDER, 155-MM GUNS, M1917-17A1-18MI.

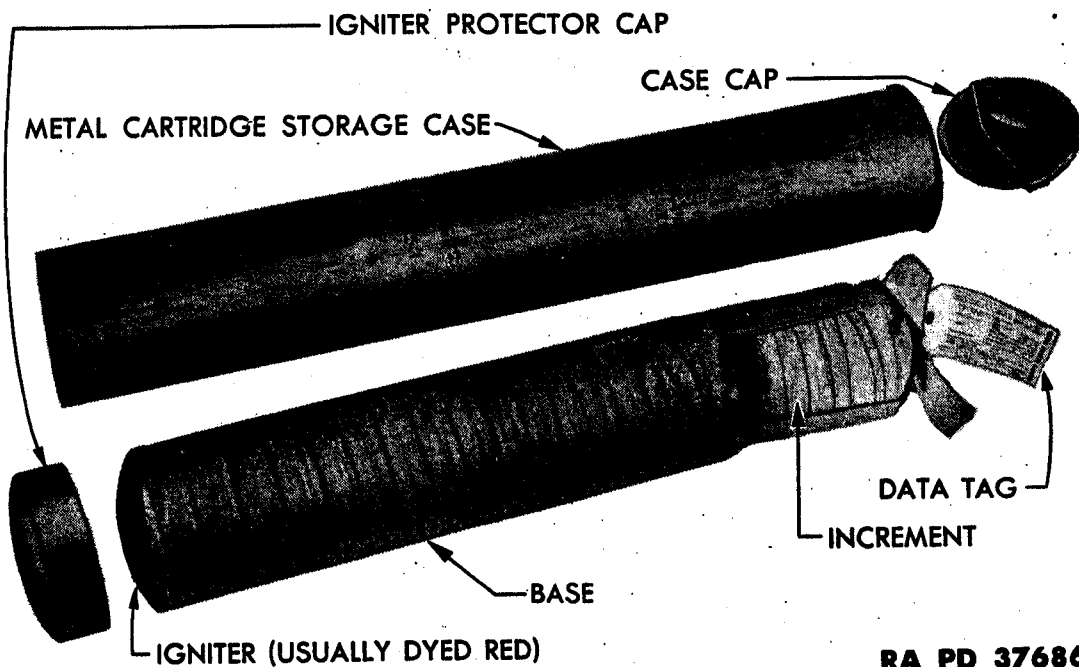

RA PD 37686

Figure 166—CHARGE, propelling, NH powder, 155-mm guns, M1917-17A1-18MI, together with metal cartridge storage case

This charge (fig. 166) is for use in the 155-mm guns, M1917, M1917A1

## AMMUNITION

and M1918MI. It differs from the charge described in paragraph 116-d chiefly in that it contains a nonhygroscopic (NH) powder. For additional information, including preparation for firing, see paragraph 116-b.

### d. CHARGE, PROPELLING, 155-MM GUNS, M1917-17A1-18MI.

This charge, except for the powder, which is nitrocellulose smokeless powder, is the same as the charge described in paragraph 116-c. For additional information, including preparation for firing, see paragraph 116-b.

## 117. FUZES

a. **General.** A fuze is a mechanical device used with a projectile to explode it at the time and under the circumstances desired. Fuzes are classified according to their manner of action as "time" or "impact". Time fuzes contain a graduated time element in the form of a compressed black powder train, or a mechanism similar to clockwork, which is set to explode the shell a certain number of seconds after firing. Impact fuzes function when the projectile strikes a resistant object. Dependent upon rapidity of action, impact type fuzes may be classified as super-quick, and delay.

**CAUTION:** No attempt whatsoever will be made to disassemble any fuze. The only authorized assembling or disassembling operation is that of assembling the fuze to the projectile or, if not fired, unscrewing the fuze from the projectile.

b. **Arming.** Artillery fuzes are so designed that they are in unarmed condition prior to firing. They become armed by forces incident to firing.

c. **Boresafe fuzes.** (1) Certain fuzes are considered "boresafe". A boresafe (detonator-safe) fuze is one in which the explosive train is so interrupted that prior to firing and while the projectile is still in the bore of the cannon, premature action of the bursting charge is prevented should any of the more sensitive elements, primer and/or detonator, malfunction.

(2) **Boresafe and nonboresafe fuzes.** Of the fuzes described herein, those classified as boresafe and nonboresafe are as follows:

**Boresafe**  
FUZE, P.D. M51,  
w/BOOSTER M21  
FUZE, P.D. M51A1,  
w/BOOSTER M21A1

**Nonboresafe**  
FUZE, P.D. M46  
FUZE, P.D. M47

## 155-MM GUN MATERIEL, M1917, M1918 AND MODIFICATIONS

Boresafe

Nonboresafe

FUZE, Time, Mechanical, M67,  
w/BOOSTER, M21A1

FUZE, Combination, 45-sec. M1907  
FUZE, Combination, 45-sec. M1914

d. FUZE, P.D., M46.

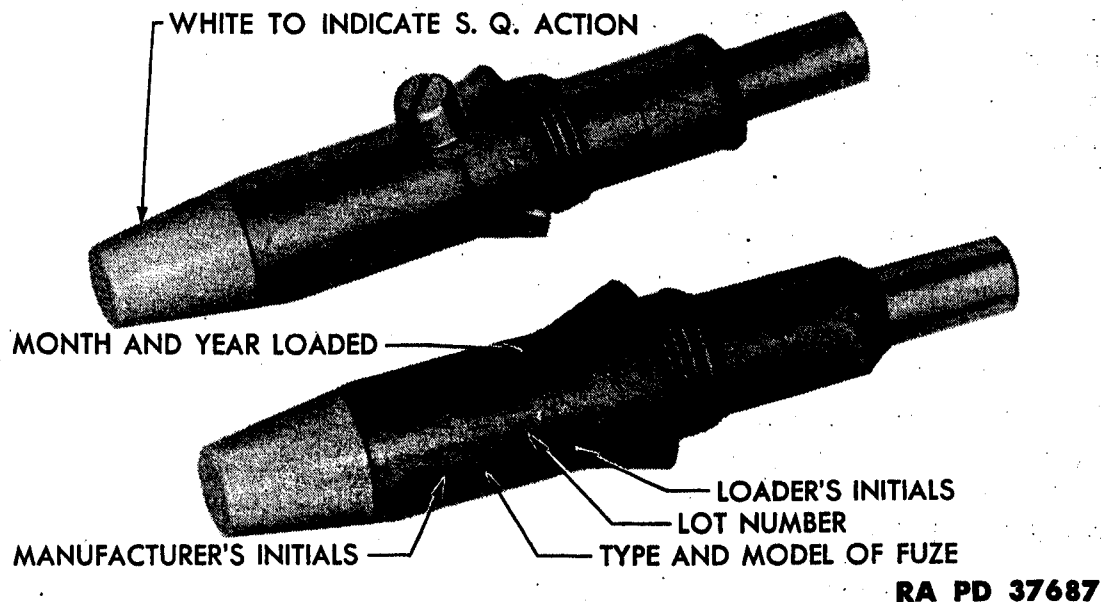

Figure 167—FUZE, P.D. (point detonating), M46. Superquick

(1) Description. (a) This fuze, a point detonating superquick type, is shown in fig. 167. A light firing pin is supported on a brass cup which is sufficiently strong to resist the setback produced by acceleration in the gun, but which is crushed when the firing pin is driven into the primer on impact.

(b) Although the external form of this fuze is the same as that of the FUZE, P.D. M47, (described below), it is readily identified by P.D.F. M46, stamped on the body, and by its head, which is painted white. The FUZE, P.D. M47, is stamped P.D.F. M47 and has a black head.

(2) Preparation for firing. To fuze the projectile, proceed as follows:

(a) Remove eyebolt lifting plug from the projectile.

(b) Inspect fuze cavity and threads. They should be free of any foreign matter which would interfere with the proper assembly of the fuze.

(c) Screw fuze into adapter by hand. (It is essential that the felt washer provided with the fuze be under the detonator socket flange when the fuze is screwed into the adapter.) Tighten with fuze wrench. The projectile is now fuzed, ready for firing.



AMMUNITION

e. FUZE, P.D. M47.

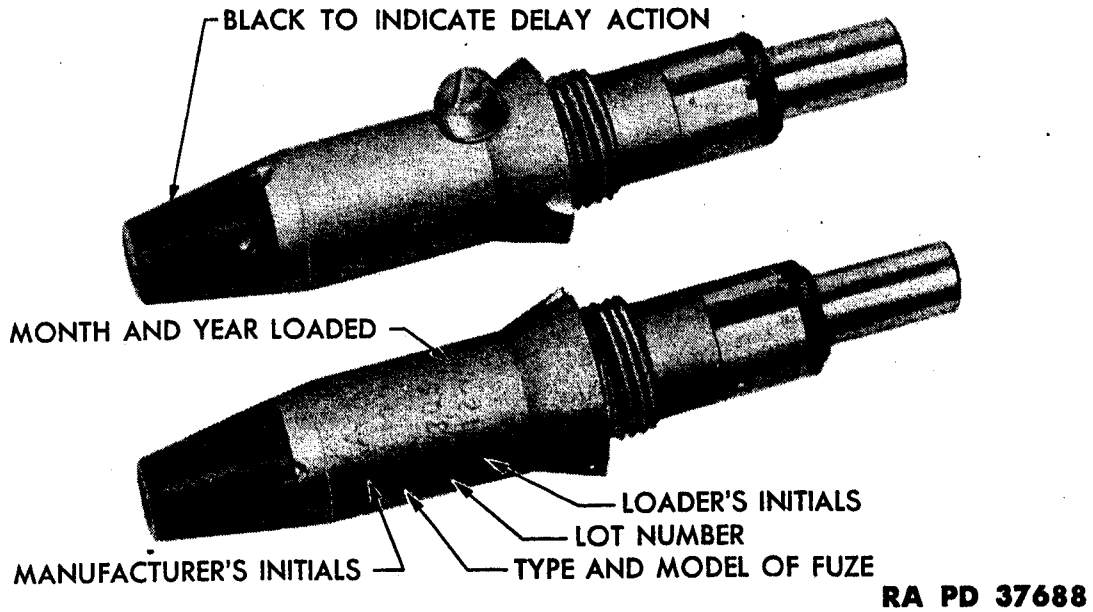

Figure 168—FUZE, P.D. M47. This fuze is of the delay type

(1) Description. This fuze, a delay type, shown in fig. 168 is identical ballistically with the FUZE, P.D. M46. It is distinguished from the latter fuze by the marking and the black head—the M46 fuze has a white head. (See also par. 117d). To provide for delay action, a delay pellet (0.05 second) is incorporated in the explosive train between the upper and lower detonator.

(2) Preparation for firing. To fuze the projectile, proceed as in paragraph 117d (2).

f. FUZE, P.D., M51 w/BOOSTER, M21.

STAMPED ON REVERSE SIDE:  
 LOADER'S LOT NUMBER  
 LOADER'S INITIALS  
 MONTH AND YEAR LOADED

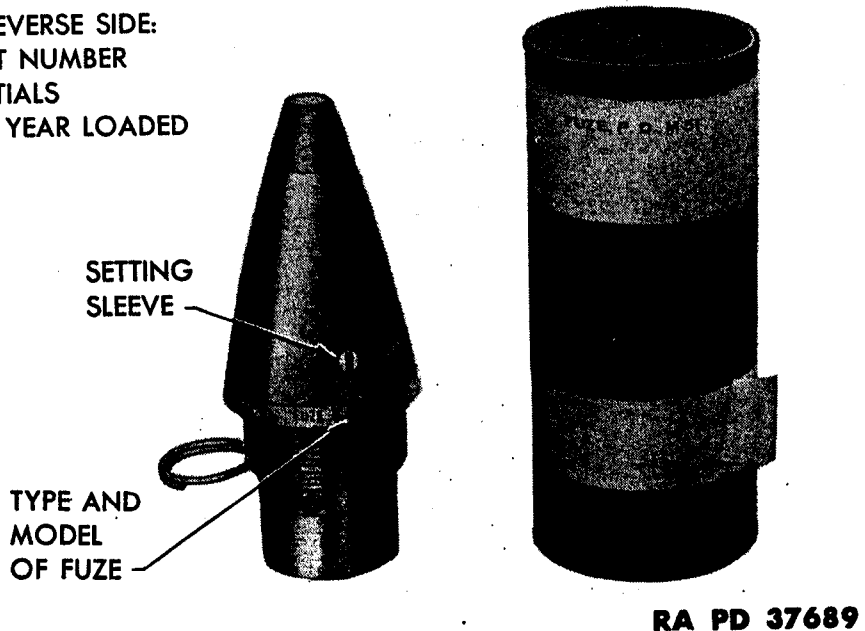

Figure 169—FUZE, P.D. M51, w/BOOSTER, M21, and container

## 155-MM GUN MATERIEL, M1917, M1918 AND MODIFICATIONS

(1) Description. (a) In this fuze (fig. 169), the booster instead of being a component of the loaded projectile is permanently attached to the fuze at the time of manufacture. The fuze contains two actions, superquick (SQ) and delay, and is classified as boresafe. Although both actions are initiated on impact, functioning of the shell depends upon the setting of the fuze.

(b) When the fuze is set for delay action, the superquick action is so interrupted that the projectile functions with delay action. It should be noted, however, that if the superquick action should malfunction when the fuze is set SQ, the projectile will function with delay action because this action is always operative.

(c) On the side of the fuze near the base is a slotted "setting sleeve" and two registration lines; the one parallel to the axis is marked SQ the other, DELAY. As shipped, the fuze is set SQ.

(d) To set the fuze for delay action, it is only necessary to turn the setting sleeve so that its slot is alined with DELAY. A delay pellet—0.05 second—incorporated in the delay action train provides for the delay action. The setting may be made or changed at will with a screw driver or other similar instrument any time before firing, even in the dark, by noting the position of the slot—parallel to the fuze axis for superquick action, at right angles thereto for delay.

(e) A cotter pin with pull ring is assembled to the booster to prevent accidental movement of the detonator during shipment. This cotter pin is to be withdrawn just prior to assembling the fuze with booster to the projectile.

(2) Preparation for firing. To fuze the projectile, proceed as follows:

(a) Remove eyebolt lifting plug from the projectile.

(b) Inspect fuze cavity and threads. They should be free of foreign matter which would interfere with the proper assembly of the fuze.

(c) Remove cotter pin from booster.

(d) Screw fuze with booster into projectile. Tighten with fuze wrench.

(e) Set fuze. If delay action is required, aline slot in setting sleeve with DELAY, if superquick, aline slot with SQ—setting as shipped. Fuze may be reset as required.

**g. FUZE, P.D., M51A1, w/BOOSTER, M21A1.**

This fuze is FUZE, P.D., M51, w/BOOSTER, M21, with certain

## AMMUNITION

mechanical modifications. It is identical in appearance with the M51 except for the marking M51A1. Preparation for firing is the same as for FUZE, P.D., M51, w/BOOSTER, M21, described in paragraph 117f.

h. FUZE, combination, 45-sec., M1907M.

STAMPED ON REVERSE SIDE:

LOT NUMBER

YEAR OF MANUFACTURE

NUMBER AND

REVISION OF

DRAWING

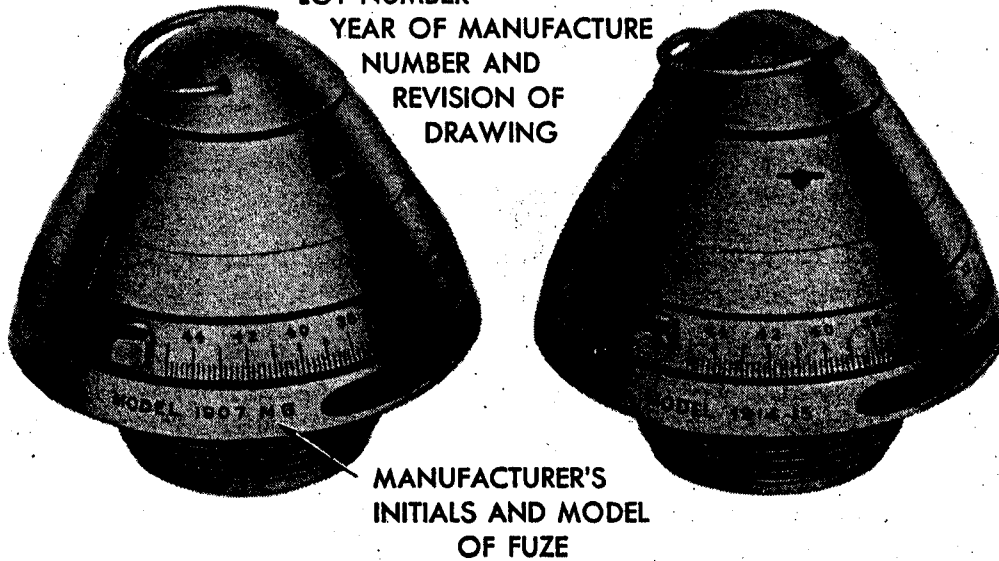

MANUFACTURER'S  
INITIALS AND MODEL  
OF FUZE

RA PD 37690

Figure 170—FUZE, combination, 45-sec., M1907M, and FUZE combination, 45-sec., M1914. For use with shrapnel

(1) Description. (a) This fuze (fig. 170) is a combination percussion-time type designed for use with shrapnel. The fuze contains two actions, percussion and time.

(b) The percussion action is always operable and will function on impact, unless prior functioning has been caused by the time action. When percussion action is required, it is only necessary to set the graduated time train ring at safe (S) or for a time longer than the expected time of flight.

(c) The time train ring is similar to that of other powder time train fuzes and is graduated for 45 seconds. The fuze is set for time by means of a fuze setter. In the particular case of zero (0) setting, canister effect is obtained, that is, the fuze functions just beyond the muzzle of the cannon with the result that the shrapnel balls are projected from the shrapnel case somewhat similar to shot from a shotgun.

(d) Because the powder time train is adversely affected by moisture, every effort will be made to keep the fuze dry. In time of war, this fuze is assembled to shrapnel as issued; in time of peace, the fuze is

issued separately for assembly in the field. A safety wire which passes through the nose of the fuze prevents accidental functioning during shipment. The fuze, as shipped, is set (S) safe.

(2) Preparation for firing. (a) As issued in time of war (fuze assembled to shrapnel):

1. Remove waterproof fuze cover and safety wire.
2. Set fuze as described in (5) below.

(b) As issued in time of peace (fuze issued separately for assembly in the field):

1. Remove fuze hole closing plug from shrapnel.
2. Inspect fuze cavity and threads. They should be free of any foreign matter which would interfere with the proper assembly of the fuze.
3. Screw the fuze into the shrapnel head. Tighten with fuze wrench.
4. Remove safety wire from nose of fuze.
5. Set fuze. If percussion action is required, the graduated time train ring is set safe (S) or for a time greater than the expected time of flight. If time action is required, the graduated time train ring is set for the required time of burning by means of a fuze setter. If canister action is required, the graduated time ring is set for zero (0) time of burning.

i. FUZE, combination, 45-sec., M1914.

This fuze is similar to, and is authorized for use instead of the FUZE, combination, 45-sec., M1907M, until present stocks are exhausted.

## 118. PRIMERS

Although made in various forms, a primer consists essentially of a small quantity of sensitive powder encased in a metal container. It is used to start the ignition of the propelling charge. As used in all 155-mm guns, the primer is similar to a blank cartridge.

a. PRIMER, percussion, 21-grain, Mk. II.

This primer is similar to and is authorized for use instead of the PRIMER, percussion, 21-grain, Mk. IIA1, until present stocks are exhausted.

b. PRIMER, percussion, 21-grain, Mk. IIA.

This primer is similar to and is authorized for use instead of the PRIMER, percussion, 21-grain, Mk. IIA1, until present stocks are exhausted.

## AMMUNITION

## c. PRIMER, percussion, 21-grain, Mk. IIA1.

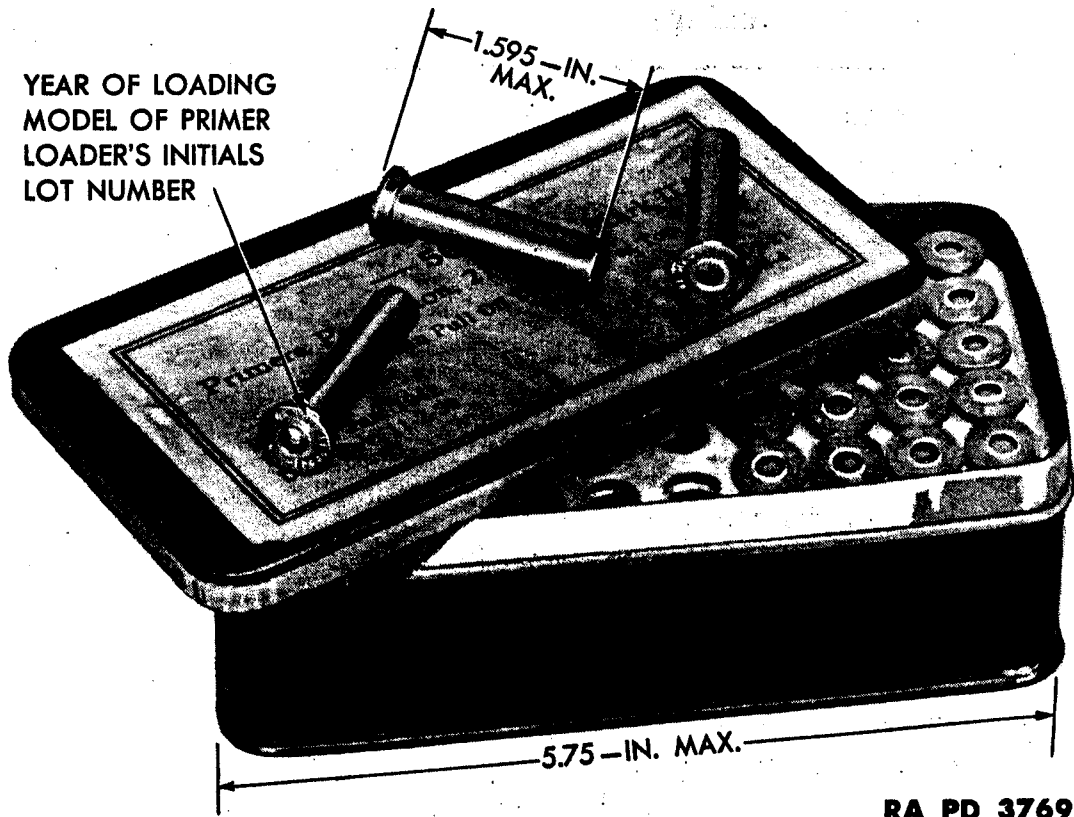

RA PD 37691

Figure 171—PRIMER, percussion, 21-grain, Mk. IIA1, and metal container which holds and protects 50 primers

This primer (fig. 171) is standard for use in the 155-mm guns. It consists of a brass case containing a percussion element and 21 grains of black powder. The percussion element in the head of the primer contains a sensitive explosive, hence should be protected from any blows which might cause accidental functioning.

### 119. PACKING

a. Complete packing data covering dimensions, volume, and weights for the various components of complete rounds are published in SNL P-1, SNL P-2, SNL P-7 and SNL P-8.

b. Although weights of individual projectiles vary somewhat, dependent upon type and model—propelling charges likewise, dependent upon the powder lot—the data on page 204 are considered representative for estimating weight and volume requirements.

### 120. FIELD REPORT OF ACCIDENTS

Any serious malfunctions of ammunition must be promptly reported to the ordnance officer under whose supervision the material is maintained or issued (see par. 7, AR 45-30).

**155-MM GUN MATERIEL, M1917, M1918 AND MODIFICATIONS**

(See par. 119, Packing)	Weight (pounds)	Volume (cubic feet)
<b>155-mm projectile:</b>		
Projectile as shipped.....	95	0.8
Over-all dimensions, 26.8-in. by 7.3-in. diameter.		
<b>CHARGE, propelling, for GUN, 155-mm, M1917, M1917A1, and M1918MI:</b>		
Charge without packing material.....	26	
1 charge in C.S.C., M5A1.....	48	1.44
Over-all dimensions of C.S.C., 40 <sup>31</sup> / <sub>32</sub> -in. by 7 <sup>25</sup> / <sub>32</sub> -in. diameter.		
2 charges per crate (each charge in C.S.C. Mk. I).....	105	4.32
Over-all dimensions of crate, 43 <sup>3</sup> / <sub>8</sub> -in. by 17 <sup>13</sup> / <sub>16</sub> -in. by 9 <sup>11</sup> / <sub>16</sub> -in.		
3 charges in bundle packing (each charge in fiber container, M45).....	109	*4.19
Over-all dimensions of bundle, 39 <sup>3</sup> / <sub>4</sub> -in. by 13.97-in. by 13.03-in.		
<b>FUZE, P.D. M51A1, w/BOOSTER M21A1:</b>		
Packed in individual fiber containers, 25 per box.....	77	1.46
Over-all dimensions of box, 17 <sup>7</sup> / <sub>16</sub> -in. by 15 <sup>7</sup> / <sub>8</sub> -in. by 9 <sup>1</sup> / <sub>32</sub> -in.		
<b>SHELL, fixed, practice, Mk. II, w/FUZE, practice, M38, 37-mm gun, M1916:</b>		
Complete round without packing material.....	1.62	
<b>Oversea shipments:</b>		
Box with metal liner (60 rounds)....	128	1.99
Over-all dimensions of box, 23 <sup>5</sup> / <sub>16</sub> -in. by 13 <sup>5</sup> / <sub>16</sub> -in. by 11 <sup>1</sup> / <sub>16</sub> -in.		
<b>Domestic shipments:</b>		
Box without metal liner (60 rounds)..	115	1.60
Over-all dimensions of box, 21 <sup>1</sup> / <sub>2</sub> -in. by 12 <sup>11</sup> / <sub>16</sub> -in. by 10 <sup>5</sup> / <sub>32</sub> -in.		

\*When quantities of bundles are shipped or stored, the actual volume required may be reduced to approximately 70 percent of the calculated gross volume, provided advantage is taken of the nesting characteristics of the bundles.

Pur  
Des  
Des  
Des  
Op  
Dis  
Dis  
As  
Bo  
Ins  
Ma  
Ca  
Pr  
Pr  
Lu  
O  
A  
1

is  
c  
I  
e  
I  
'

Section XIV  
SUBCALIBER EQUIPMENT

	Paragraph
Purpose.....	121
Description of breechblock and breech mechanism.....	122
Description of recoil mechanism.....	123
Description of the mount.....	124
Operation.....	125
Disassembly and assembly—gun.....	126
Disassembly and assembly—gun from cradle.....	127
Assembly and disassembly—mount.....	128
Bore sighting.....	129
Inspection.....	130
Malfunction and correction.....	131
Care and preservation.....	132
Precautions.....	133
Practices to be avoided.....	134
Lubrication.....	135
Organization spare parts and accessories.....	136
Ammunition.....	137

**121. PURPOSE**

Subcaliber equipment, which is used for training purposes only and is not taken into the theater of operations, consists of the 37-mm subcaliber gun, M1916, the tank cradle, M1916, the subcaliber mount, M1 (fig. 172), and accessories. It is used to provide practice in laying and firing the 155-mm gun materiel. The use of smaller bore ammunition prevents wear on the regular piece during practice, and is less costly. The actual handling, loading and range obtained are different. The subcaliber equipment is complete with recoil mechanism and does not operate the recoil mechanism of the 155-mm gun.

**122. DESCRIPTION OF BREECHBLOCK AND BREECH MECHANISM**

a. **Breechblock.** (1) The breechblock (fig. 173) is of the Nordenfeld type, somewhat similar (except in size) to that of the 75-mm gun, M1897. The breechblock screws into the breech ring and rotates through an angle of 156° about its own axis. The axis of the breech recess is below the axis of the bore.

155-MM GUN MATERIEL, M1917, M1918 AND MODIFICATIONS

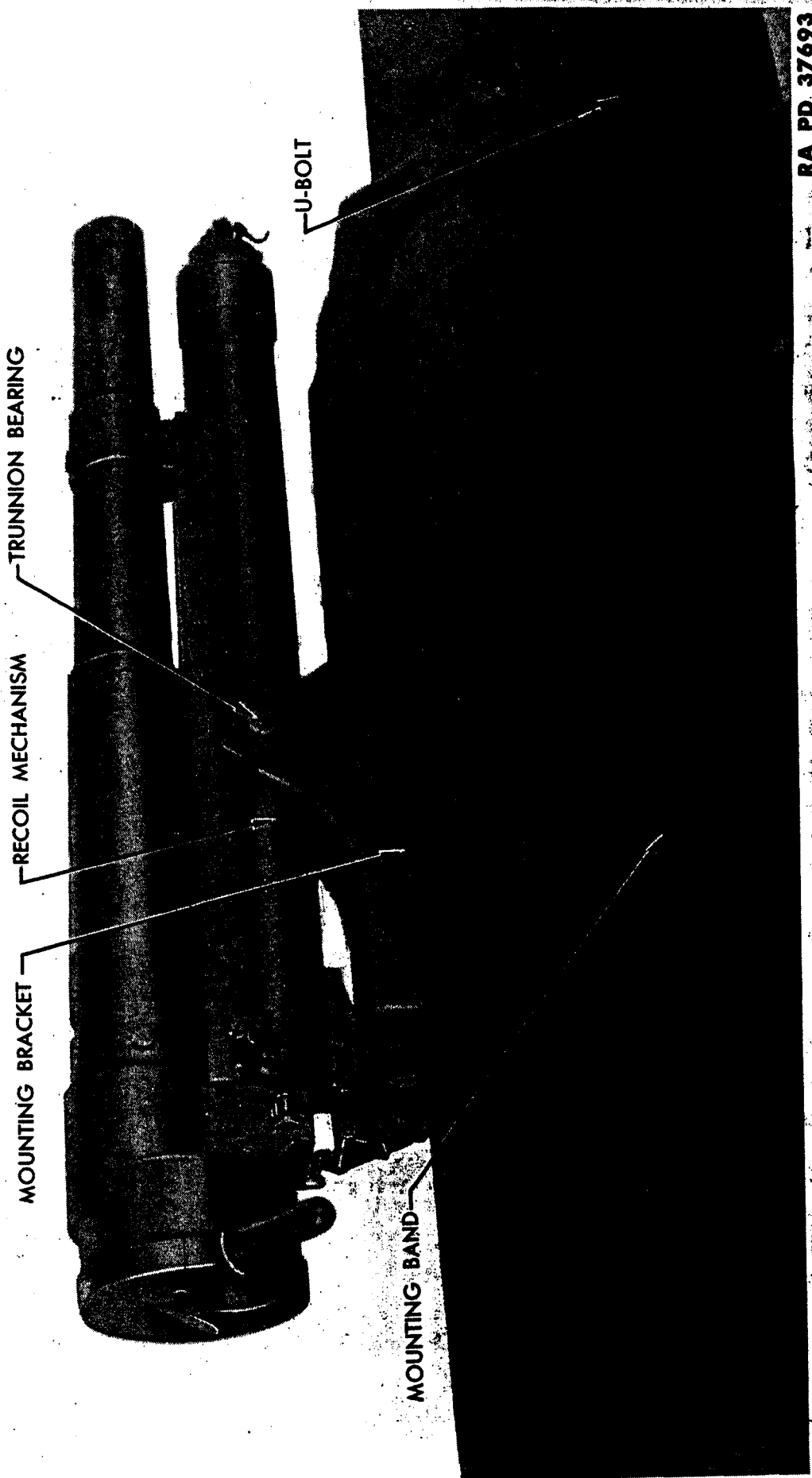

RA PD 37693

Figure 172. The 37-mm subcaliber gun, M1916, with tank cradle, M1916, mounted on the 155-mm gun, M1917A1, by means of the 37-mm subcaliber mount, M1

5  
4  
3  
2  
1



## SUBCALIBER EQUIPMENT

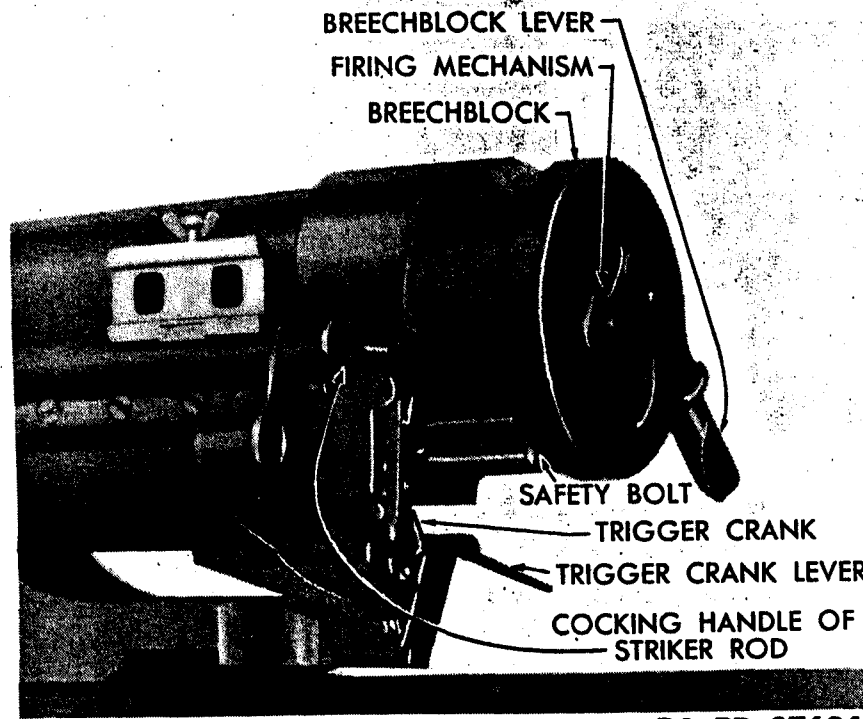

RA PD 37694

**Figure 173—Left rear view of breechblock and breech mechanism of the 37-mm subcaliber gun, M1916**

(2) The breechblock is operated by the breechblock lever (fig. 173) which, when moved to the left, causes the breechblock to rotate and carries the open portion to a position in line with the bore. This open portion is bored for the loading and extraction of the cartridge case. The breechblock, in opening, also operates the extractor, which extracts and ejects the cartridge case.

(3) The breechblock is closed when the lever is moved to the right. With this operation, the firing pin is placed in line with the percussion cap, in the base of the cartridge case, and the safety bolt is released.

b. **Safety bolt.** The safety bolt (fig. 173) prevents the firing of the gun, if the breechblock is not fully closed.

c. **Firing mechanism.** The firing mechanism (fig. 173) which is housed in the breechblock, consists of the firing pin, firing pin spring, rocker, rocker pin, rocker pin latch, and rocker plunger. When the trigger crank lever (fig. 173) is pressed down, the firing pin strikes the percussion cap of the cartridge case, and the gun is fired.

### 123. DESCRIPTION OF THE RECOIL MECHANISM

a. The recoil mechanism (figs. 175 and 176) is located in the cradle underneath the gun. The gun slides upon it during recoil and counter-

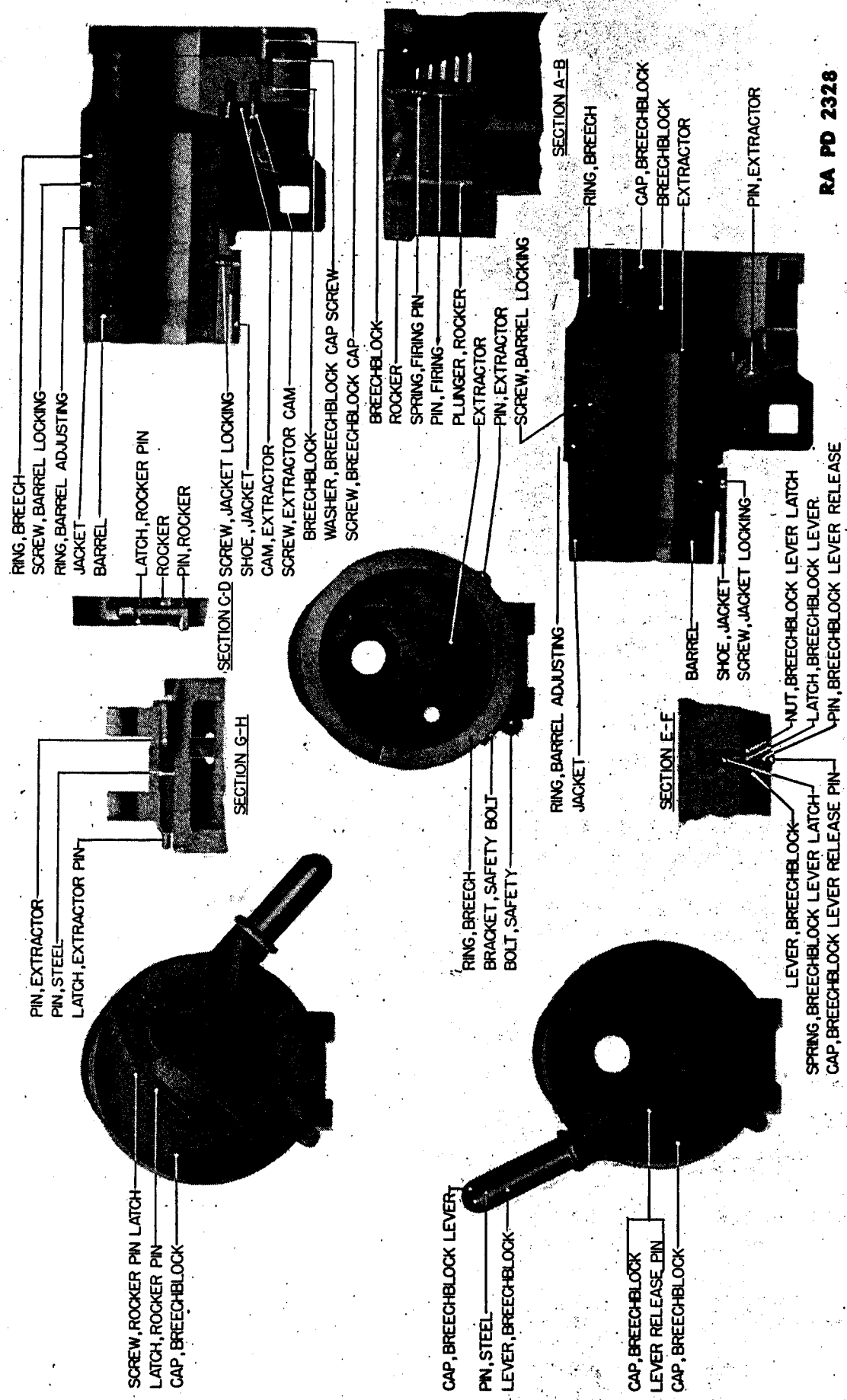

RA PD 2328

Figure 174—Rear and sectional views of breechblock of 37-mm gun

### SUBCALIBER EQUIPMENT

recoil. It consists of the recoil mechanism, the counterrecoil mechanism and the counterrecoil buffer.

b. The recoil mechanism is provided to control the backward thrust of the gun created by firing, and to check the movement of the gun in a gradual manner. The counterrecoil system is provided to return the gun into battery in order that it may be fired again. The counterrecoil buffer slows down and stops the counterrecoil action without injury to the system.

#### 124. DESCRIPTION OF THE MOUNT

The 37-mm subcaliber mount, M1 (fig. 172), is composed of the mounting bracket, the mounting band, two trunnion caps, a U-bolt with the necessary nuts and lock washers, four cap screws and two set screws. Trunnion bearings retain the tank cradle in position and provide a means of adjustment for deflection. The mounting bracket fits on top of the 155-mm gun as shown in fig. 172.

#### 125. OPERATION

a. The normal position for operating the subcaliber equipment is from the right side. Caution is required on the first round because the gunner is compelled to reach across the gun to cock the firing mechanism. Subsequent firing cocks the gun automatically. Further caution is required when firing the gun at extreme positions of elevation and traverse.

b. To cock. Place the palm of the hand against the cocking handle on the striker rod. Push it forward until it latches. If a round is not to be fired, remove it from the gun. Do not attempt to uncock the gun while it is loaded because the mechanism must be cocked before the breech may be opened.

c. To open the breech. Rotate the breechblock lever to the left as far as it will go. The gun has no breechblock latch to hold the breechblock in the open or closed position.

d. To load. Insert a round of ammunition, pushing the cartridge case in as far as the extractor will permit.

e. To close the breech. Rotate the breechblock lever as far to the right as it will go. During the first part of this movement, a ramp on the front of the breechblock pushes in the cartridge case flush with the face of the breechblock. The cartridge case is rammed home by the forward movement of the breechblock in the breechblock threads.

RA PD 2328

Figure 174—Rear and sectional views of breechblock of 37-mm gun

TWIN BREECHBLOCK LEVER RELEASE

155-MM GUN MATERIEL, M1917, M1918 AND MODIFICATIONS

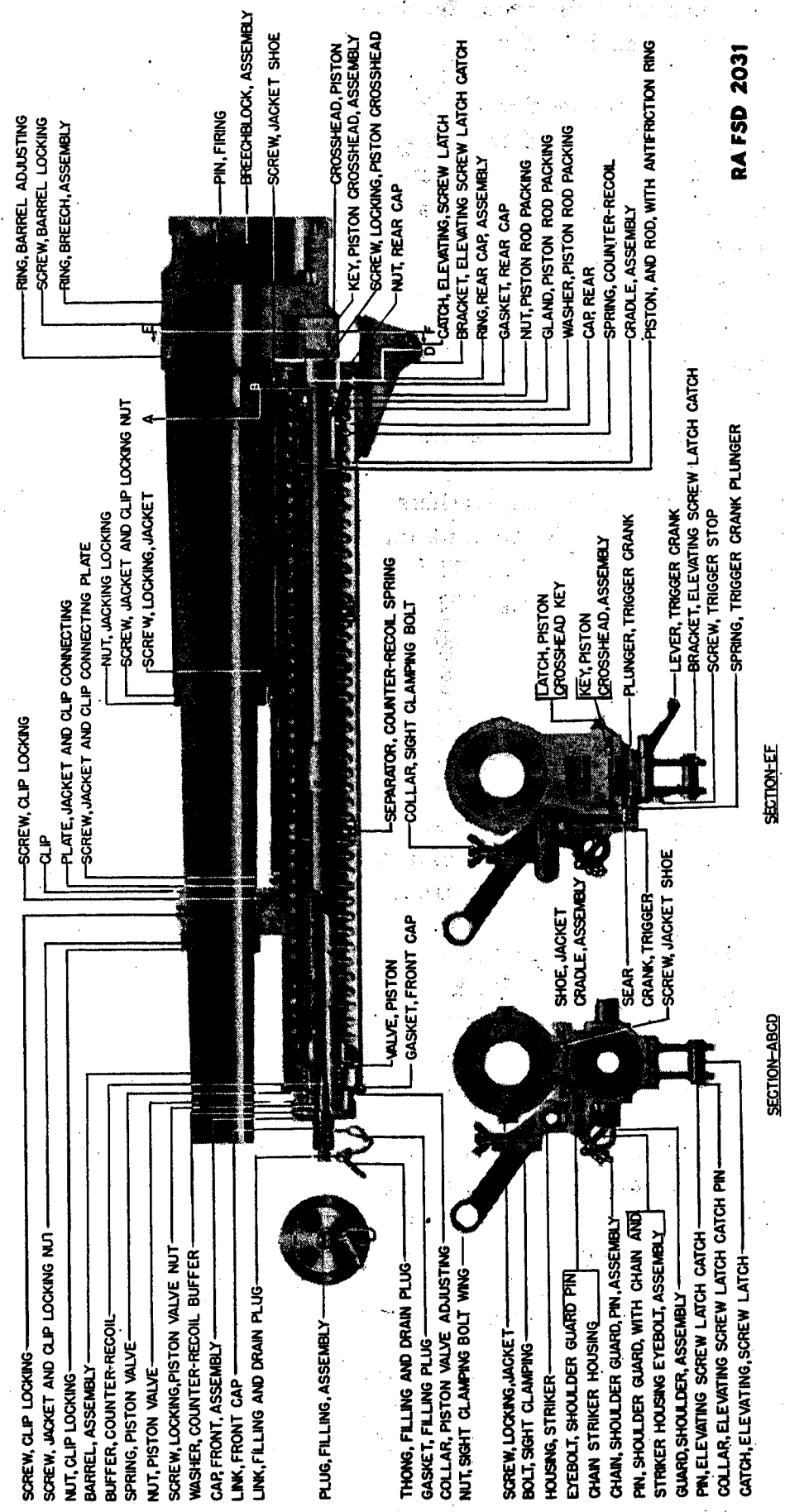

RA FSD 2031

Figure 175—Sectional views of 37-mm gun and recoil mechanism

SUBCALIBER EQUIPMENT

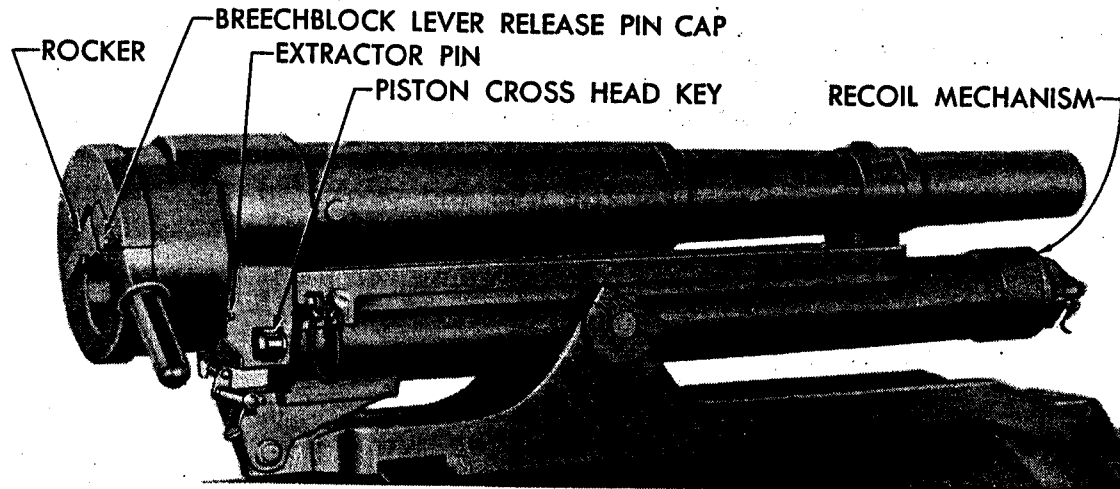

RA PD 37695

Figure 176—Right rear view of the 37-mm subcaliber gun, M1916

126. DISASSEMBLY AND ASSEMBLY—GUN

a. To dismount breechblock. Cock the piece. Remove the breechblock lever by grasping the handle, and pressing the breechblock lever release pin cap (fig. 176) with the thumb, and pulling the lever from its channel. Take out the extractor pin (fig. 174) by pressing the extractor pin toward the breech with the left forefinger and pulling it out to the right with the right hand. The extractor will drop down until its heel clears the extractor cam. Unscrew the breechblock, grasping it firmly with the right hand, supporting it with the left hand and unscrewing it to the left.

b. To replace breechblock. (1) See that the breech recess, extractor and threads of the breechblock are thoroughly clean and lightly oiled. Set the extractor in its seat, but do not put in the extractor pin. Cock, if the gun is not already cocked. Screw the breechblock home. Put the breechblock lever in place.

(2) Raise the extractor by pushing upward on its heel from under the block. Put in the extractor pin from the right until the extractor pin latch springs out and secures the pin. Uncock the gun by pressing down on the trigger lever while using pressure against the cocking handle to prevent too fast movement of the striker.

**CAUTION:** Do not attempt to unscrew or screw in the breechblock without first removing the extractor pin.

c. To dismount extractor. Dismount the breechblock as directed in paragraph 126a. Withdraw the extractor by inserting the left forefinger in the mortise in the base of the breech ring, raising the extractor a little, and grasping it with the thumb and forefinger of the right hand.

ATIONS

RA FSD 2031

Figure 175—Sectional views of 37-mm gun and recoil mechanism

**155-MM GUN MATERIEL, M1917, M1918 AND MODIFICATIONS**

d. To assemble extractor. Put in extractor. Then follow procedure outlined in paragraph 126b.

e. To dismount rocker, rocker plunger and firing pin. Gun should be cocked, or the breechblock should be dismounted. The rocker pin is retained in its seat by the free end of the spring entering the groove in the outer end of the rocker pin. This spring may become stuck with paint and should be freed, by scraping the paint from around the edge, before attempting to remove the rocker pin. The rocker pin projects at one side of the port. Place a small bronze drift against the projecting head and, with light taps, drive the pin into the port. The rocker is now free and, when removed, exposes the firing pin, which will be pushed out by its spring, and the rocker plunger, all of which may then be taken out.

f. To assemble rocker, rocker plunger and firing pin. Clean and lubricate all parts. Put in rocker plunger, firing pin spring and firing pin. Hold the rocker down in its seat with your thumb until the rocker pin can be started through. Push the pin home, and see that the rocker pin latch springs into its groove.

g. To remove piston cross head key. Disengage striker. Press up on piston cross head key latch and push key out to the left.

h. To assemble piston cross head key. Clean, examine and lubricate parts. Push the key into place with the trigger crank lying in front of the long arm of the sear. See that the safety bolt properly engages the depending arm of the sear before the piston cross head key is pushed fully home. Failure to have the safety bolt in the proper position will prevent the cross head key from being fully pushed in, and an attempt to force it will cause damage to the sear.

i. To disassemble striker mechanism. Having removed the piston cross head key, draw the gun back about eight inches and push the striker to its extreme forward position to loosen the striker rod nut setscrew and unscrew the striker rod nut. Allow the spring to expand slowly and push the striker rod out. Clean all parts. The free height of the striker spring is 6.81 inches. If it is as much as 0.5 inch less than this, replace.

j. To assemble striker mechanism. (1) Slush thoroughly the striker spring and striker rod with light lubricating oil. Place the striker spring over the rod and insert them in the striker housing. Push the striker to the extreme forward position and screw the striker rod nut until the front edge of the nut is about flush with the front end of the striker rod. Take care that the striker rod nut setscrew is opposite its keyway in the striker housing.

(2) The stroke of the striker rod may be lengthened by unscrewing

## SUBCALIBER EQUIPMENT

the striker rod nut a few turns. The setscrew must not be omitted, and must be well set in so that it does not strike the bottom of the keyway.

## 127. DISASSEMBLY AND ASSEMBLY—GUN FROM CRADLE

a. Disassembly. Release striker. Take out piston cross head key (see par. 126g). Draw the gun carefully from the rear of the cradle.

b. Assembly. See that gun slides and piston cross head are thoroughly clean and lubricated. Insert gun into the cradle from the rear, carefully maintaining alinement to avoid jamming the gun slides. Replace piston cross head key (par, 126h).

## 128. ASSEMBLY AND DISASSEMBLY—MOUNT

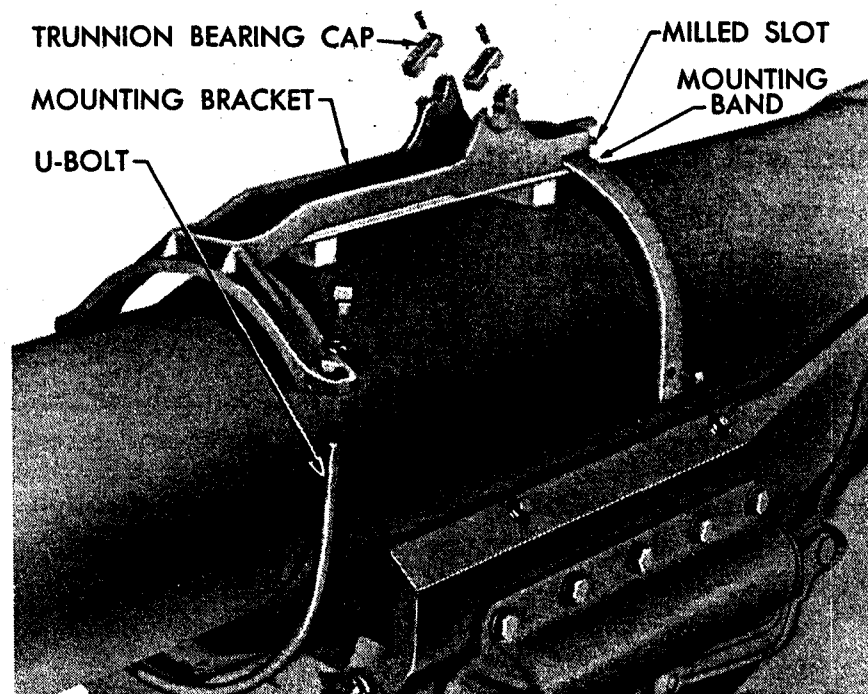

RA PD 37696

Figure 177—Exploded view of the 37-mm subcaliber mount, M1

a. Assembly. (1) Place the mounting bracket (fig. 177) on top of the 155-mm gun with its front edge approximately  $117\frac{1}{2}$  inches from the muzzle and with the holes in the bottom of the rear mounting band alined with those in the gun. Place the U-bolt around the gun from underneath and up through the holes in the front arms of the mounting bracket. Secure the U-bolt with lock washers and nuts. Tighten the setscrews of the rear mounting band. This will force the lower ends of the mounting band against the cradle flanges and draw the rear end of the mounting bracket firmly to the gun.

(2) Remove the trunnion bearing caps from the mounting bracket. Lift the 37-mm subcaliber gun, with its tank cradle, to the top of the 155-

**155-MM GUN MATERIEL, M1917, M1918 AND MODIFICATIONS**

mm gun and assemble the elevating screw latch catch in the milled slot at the back of the mounting bracket. Lower the gun and tank cradle into the trunnion bearings and replace the trunnion caps. It is essential that the trunnion caps be assembled to their mating trunnions as they are not interchangeable.

b. **Disassembly.** Disassembly is accomplished by reversing the procedure required for assembly.

**129. BORE SIGHTING**

a. As the 37-mm subcaliber gun is to be laid with the regular sighting and maneuvering mechanism of the 155-mm gun, the bores of the guns must be parallel.

b. Verification of the gun sights having been accomplished with the testing target, as described in paragraph 94g, there only remains to aline the 37-mm subcaliber gun with the 155-mm gun. This is accomplished with the same testing target as follows:

(1) With the carriage level, as described in paragraphs 94g (1) and (2) and with the target positioned as described in paragraph 94g (3), use the bore sights for the 155-mm gun to line up the bore of the 155-mm gun to pierce the lower circle of the target.

(2) Use the bore sights for the 37-mm subcaliber gun to pierce the small upper circle of the target both vertically and laterally.

(3) The adjustment of the 37-mm subcaliber gun upon the target is made by placing shims under the mounting bracket, and by adjusting the nuts and screws of the mounting bracket.

**130. INSPECTION**

Careful and frequent inspection should be made of the materiel to discover any parts which need attention and adjustment.

**Parts to be inspected**

**Points to observe**

a. Gun and recoil mechanism as a unit.

a. General appearance. Condition of paint. Try ejection with an empty shell case.

b. Breechblock.

b. Rotate breechblock from right to left and back several times, noting whether there is any stiffness or binding. Depress breechblock lever release pin cap and pull out breechblock lever. Remove extractor pin. Rotate breechblock in a counterclockwise direction until threads on breechblock are disengaged from threads in barrel. Examine threads for burs



**SUBCALIBER EQUIPMENT**

and rough surfaces. Note firing pin hole in face of breechblock. Depress rocker plunger and note how far firing pin protrudes. With rocker plunger fully depressed, firing pin should protrude approximately  $\frac{1}{8}$ -inch. Remove rocker pin, turn breechblock over and allow rocker plunger, firing pin and firing pin spring to drop out. Examine these parts for rust and burred surfaces. Try tension of firing pin spring; free length  $\frac{25}{32}$ -inch. Try tension of breechblock lever latch spring.

c. Firing mechanism.

c. Try tension of striker spring and sear plunger spring. Try action of trigger crank and trigger crank lever. Trigger crank plunger should have tension enough to hold trigger crank in place. Note sear and sear notch for burs and worn surfaces.

d. Barrel.

d. Note threads in breech for burs and rough surfaces. Chamber and barrel should be free from pits and rust. Remove piston cross head key, and slide barrel back to insure that jacket shoe and recoil ways are free from burs.

e. Recoil mechanism.

e. (1) Remove barrel assembly from recoil mechanism and note front and rear caps for oil leaks, and leaks at piston rod packing washer. Check quantity of oil in recoil mechanism.

(2) Make a reaction test. A simple reaction test may be made by manually retracting the gun, blocking it with a piece of wood about 10 inches long, and pulling out the block with a cord or wire. The gun should return to battery quickly, but without shock.

**131. MALFUNCTION AND CORRECTION**

a. Gun fails to return completely to battery. (1) Incomplete return to battery is evident when the firing mechanism does not cock, or the cocking is not sufficient to produce discharge of the next shot. This may be caused by weakened counterrecoil springs, dirty, bent, burred or scratched jacket shoe guides and slides, a bent recoil cylinder, or an excess of oil in the recoil mechanism. The latter may be

CATIONS  
milled slot  
cradle into  
essential that  
s they are  
ersing the  
regular  
bores of  
ed with  
ains to  
is ac-  
4g (1)  
1g (3),  
5-mm  
ierce  
rget  
ting  
to  
t.

**155-MM GUN MATERIEL, M1917, M1918 AND MODIFICATIONS**

due to expansion of the oil caused by excessive friction accompanying continued firing, and may be relieved by releasing some of the oil.

(2) If it is surmised that the condition of the guides is causing the difficulty, the gun should be dismounted and the guides examined for traces of excessive friction, scratching, fouling, etc. Remedy by careful use of a fine file and thorough cleaning and oiling. Test the operation of the gun in the slides before replacing the piston cross head key.

• b. Gun returns to battery too abruptly. Sudden return into battery position with a jarring impact is due to incomplete buffing at the end of the counterrecoil, or to insufficient oil in the recoil system. Ordinarily, the addition of oil to the recoil system will remedy either of these conditions. Add oil as described in paragraph 132b.

c. Breech will not open. The gunner may have failed to release the trigger crank lever, or have failed to cock the gun. Other causes of irregularity are a worn or broken sear, a worn or broken shoulder on the striker rod, or defective sear plunger and springs. Determine the cause, and correct.

d. Trigger cannot be depressed sufficiently to fire. Where the trigger crank lever cannot be depressed sufficiently to operate the firing mechanism, the fault can usually be attributed to incomplete closure of the breech, which causes the safety mechanism to lock the sear. The cartridge case should be examined for a damaged rim or other defects tending to prevent its insertion in the chamber. Another shell may be tried. If the loading is not the cause of the difficulty, examine the chamber for dirt or fouling, and the trigger mechanism for broken parts or foreign matter preventing smooth operation. Broken or damaged parts should be replaced.

e. Gun fails to fire. Failure to fire may result from the gun not being cocked, the breech not being fully closed, defective ammunition, a weakened striker spring, a worn or broken firing pin, a broken sear, or dirt in the firing pin recess. If two percussions are frequently necessary to produce discharge, the striker spring either has become weakened and should be replaced, or the spring is clogged with dirt and hardened grease so that it cannot function properly. If no defect can be found in the firing mechanism, and a shell does not fire after three percussions, wait for two minutes, then replace the shell with another because the primer of the other, no doubt, is defective.

f. Shell fails to extract. Defective extraction may occur when the breech is opened slowly, the extractor pin is out, or the extractor is damaged or broken, or when the cartridge case tends to stick in the chamber because the edge of the chamber is burred or fouled with powder. A poor cartridge case may stick in the chamber due to expansion, in

## SUBCALIBER EQUIPMENT

which case the hand extractor should be used to complete extraction. Careful use of a fine file will correct sticking caused by burring of the chamber. If the extractor is broken or damaged, it should be replaced.

### 132. CARE AND PRESERVATION

a. Gun. The materiel should be kept in perfect condition, and cleaned and oiled thoroughly. Only such cleaning and preserving materials as are issued for this purpose will be used. It is especially important that all parts of the gun be kept free from rust. The following instructions for cleaning these parts will be strictly observed:

(1) Bore and chamber of the gun require particular attention and will be thoroughly cleaned within one hour after firing. Wash until clean; then dry the bore thoroughly, using burlap or cloths; then oil the bore.

(2) The breechblock and firing mechanism will be thoroughly cleaned. All parts and recesses and breechblock threads will be lightly oiled.

(3) The trigger mechanism will be kept free from dust and foreign matter, and after use, all parts will be carefully wiped dry, and a drop of oil will be put on striker bearings, trigger bearings and the safety bolt.

(4) Gun slides will be cleaned and freely oiled.

b. Recoil mechanism. To fill an empty recoil mechanism,  $2\frac{3}{4}$  pints of oil, or 21 oil gun refills, are required. Heavy recoil oil only is issued for use in the recoil mechanism. Following is the procedure for filling the recoil mechanism:

(1) Raise the rear end of the cradle higher than the front.

(2) Fill the oil gun. Unscrew the nozzle. Pull the plunger back. Fill the oil gun with heavy recoil oil. Replace the nozzle. Push up the plunger gently to force out the air.

(3) Remove the filling plug of the recoil system. Screw the oil gun into the filling hole. Remove the drain plug. Push in the plunger of the oil gun slowly and, at the same time, watch for the escape of oil from the drain hole. When oil, free from bubbles, runs from the drain hole, the recoil system is full.

(4) Remove the oil gun. Before replacing the filling and drain plugs, let about two tablespoonfuls of oil escape; then screw the two plugs in tightly. This is necessary as the expansion of oil during prolonged fire may interfere with the complete return of the gun to battery.

**NOTE:** No adjustment of the recoil mechanism by the using arm is permitted. Report any need for adjustment to the ordnance maintenance personnel.

**155-MM GUN MATERIEL, M1917, M1918 AND MODIFICATIONS**

c. **Mount.** When the subcaliber mount is dismounted, all screws, nuts and lockwashers should be assembled to the mount to prevent their being lost. Repairs will be minor in nature, involving only the removal of burrs, when necessary, and the replacement of defective parts.

**133. PRECAUTIONS**

The precautions which must be observed before, during and after firing are:

a. **Before firing.** Make certain that:

- (1) Bore is clean and dry.
- (2) Recoil mechanism is correctly filled.
- (3) Sight is clean, adjusted and lock nuts are tight.
- (4) All parts are functioning properly.
- (5) Spare parts set is complete. See pertinent SNL.
- (6) All moving parts are oiled.
- (7) Retraction test is made. See paragraph 130e (2).

b. **During firing.**

- (1) In case of a misfire, recock, relay and make three attempts to fire. If failure continues, wait two minutes before opening the breech.
- (2) Release trigger crank lever promptly.
- (3) Keep clear of the path of recoil.

c. **After firing.**

- (1) Clean piece thoroughly within one hour after firing.
- (2) Examine gun and cradle for worn, loose or broken parts.

**134. PRACTICES TO BE AVOIDED**

Certain practices which must be avoided, if efficient operation is to be maintained, are:

a. No attempt should be made to repair or disassemble the recoil mechanism, except by ordnance maintenance personnel. Using arm may fill or drain it as necessity requires.

b. Avoid working the trigger mechanism when there is no cartridge in the chamber. Do not attempt to force the trigger crank lever when the breech is not completely closed because the sear is locked by the safety bolt on the under side of the breech ring.

c. The breechblock should not be moved when the striker is not cocked.

**SUBCALIBER EQUIPMENT**

d. The walls of the recoil cylinder, and of the striker housing attached to the cradle, are relatively thin. Therefore, dropping the cradle may dent these walls and cause internal interference.

**135. LUBRICATION**

a. Proper lubrication of the bearing surfaces is necessary, if the mechanism is to function smoothly and give long service. The 37-mm subcaliber gun materiel has very few oil holes or special lubricating fittings yet it requires frequent oiling of certain bearings.

b. The following chart gives locations where lubrication is necessary, as well as the method of application, the amount required, and the frequency of oiling in active service.

**Lubricating Chart, 37-mm Subcaliber Gun Materiel, M1916**

All lubricating to be performed with oil, engine,  
SAE 10 (below 32 F.) SAE 30 (above 32 F.).

Part	Method	Frequency
Bore.....	Slush.....	After firing or weekly. First clean bore.
Breechblock.....	Spread oil on threads...	Daily. Unscrew breechblock.
Firing pin.....	Drops at contact surfaces.....	Daily. While breechblock is dismantled.
Extractor and extractor pin.....	.....ditto.....	.....ditto.....
Safety bolt.....	Drops at end of bracket.....	.....ditto.....
Striker rod.....	.....ditto.....	.....ditto.....
Sear.....	Drops at bearing surface.....	.....ditto.....
Piston cross head key....	Drops at contact surface ...	At assembly ...
Striker spring.....	Slush.....	.....ditto.....
Gun slides.....	Cover bearing surfaces... ..	Dismount gun..
Trigger crank.....	One drop at each end of bearing.....	Once a week...

155-MM GUN MATERIEL, M1917, M1918 AND MODIFICATIONS

136. ORGANIZATION SPARE PARTS AND EQUIPMENT

a. Organization spare parts. A separate set of spare parts is supplied to the using arm for each subcaliber gun. After the initial issue, the set will be kept complete by requisitioning new parts to replace those used. Allowances are prescribed in the SNL's for the major equipment.

b. Accessories. The accessories are tools and equipment issued to the using arm for cleaning and preserving the subcaliber gun and mount, and for keeping a complete record of their use.

137. AMMUNITION

Authorized rounds, and a table of characteristics of the ammunition for the 37-mm subcaliber gun, M1916, are given in the Ammunition chapter of this manual, pages 189 (Table 1), and 192 and 193 (Table 2).

Org  
Acc

138

for  
or  
ne  
SI

π

1

Section XV

ORGANIZATION SPARE PARTS AND ACCESSORIES

	Paragraph
Organization spare parts.....	138
Accessories.....	139

138. ORGANIZATION SPARE PARTS

a. A set of organization spare parts is supplied to the using arm for field replacement of those parts most likely to become broken, worn or otherwise unserviceable. The set is kept complete by requisitioning new parts for those used. Organization spare parts are listed in pertinent SNL's. (See "References" Section of this manual.)

b. Care of organization spare parts is covered in the section of this manual entitled "Care and Preservation."

139. ACCESSORIES

a. Accessories include tools and equipment required for such disassembling as the using arm is authorized to perform, and for the cleaning and preservation of the gun, carriage, sighting and fire control equipment, ammunition, etc. They also include chests, covers, tool rolls and other items necessary to protect the materiel when it is not in use, or when traveling. Accessories should not be used for purposes other than as prescribed, and when not in use, should be properly stored.

b. There are a number of accessories, the names or general characteristics of which indicate their use. Others, embodying special features, or having special uses, are described below:

(1) **Ammeter.** The ammeter is for use with the gun carriages equipped with electric brakes. Its use is indicated in paragraphs 56, 69 c (5), and 74.

(2) **Beam, jack, M3.** (Fig. 179, No. 1.) The purpose of the jack beam is to facilitate the maneuvering of the trails to the traveling or firing position. The jack beam is an I-beam of 103-inch length having an end piece fitted at each end. In the center of the beam is a fulcrum member which is fitted to the top side. A fin of the fulcrum fits within a slot in the maneuvering lug at the rear of the bottom carriage where it is held in position by a pin.

(3) **Band, caterpillar.** These bands provide more bearing surface under the wheels in both traveling and firing positions. They are assembled over the tires of carriages and limbers equipped with solid rubber tires. Each band consists of 12 segments and shoes hinged by

TIONS  
VT  
parts is  
e initial  
> replace  
e major  
  
t issued  
un and  
  
nition  
nition  
1 193

155-MM GUN MATERIEL, M1917, M1918 AND MODIFICATIONS

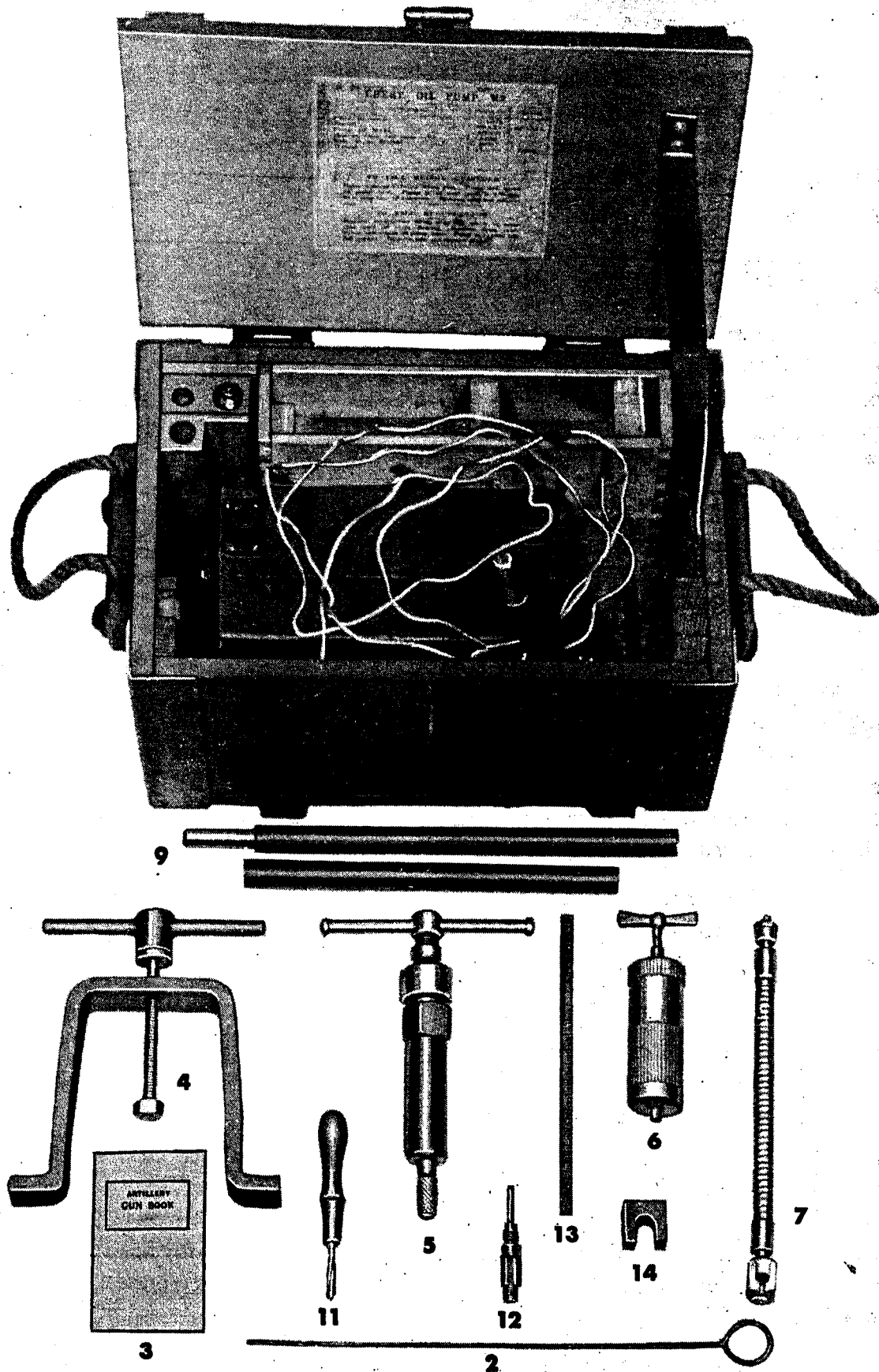

RA PD 37706

Figure 178—Oil pump, M2A1, and other accessories for 155-mm gun materiel, M1917 and M1918



## ORGANIZATION SPARE PARTS AND ACCESSORIES

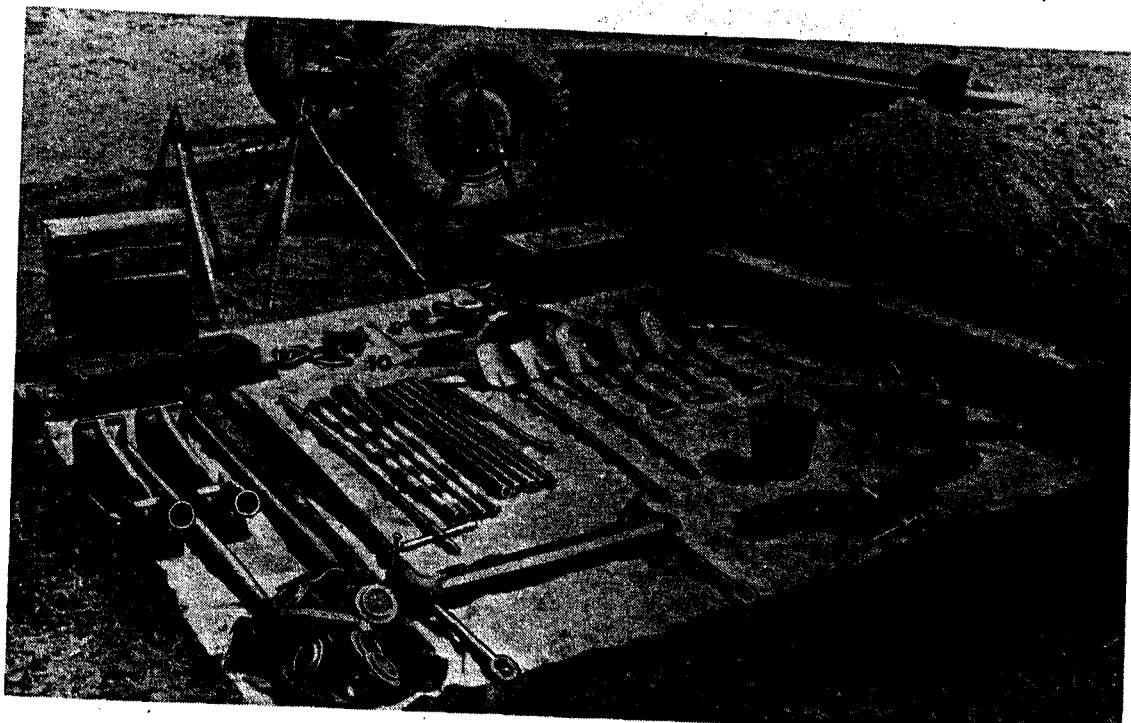

RA PD 37567

*Figure 179—Firing accessories for the 155-mm gun, M1917, M1918*

segment pins. There are 11 type A segments and one type B segment. After a tire wears to a smaller diameter and the segment pins wear at their bearing surfaces, the type B segment is replaced by a smaller type A segment.

(4) Bit, vent cleaning. (Fig. 178, No. 2.) The vent cleaning bit is a steel rod with a looped handle and a fluted end for cleaning the obturator spindle vent.

(5) Book, artillery gun. (Fig. 178, No. 3.) The gun book (0.0. Form 5825) is used to keep an accurate record of the materiel, and remains with the piece regardless of where it may be sent. It includes records of assignments, the battery commander's daily record, and the inspector's record of ammunition. The gun book contains a page of instructions pertaining to its use.

**NOTE:** Records of assignment data must be removed and destroyed prior to entering combat.

(6) Brush, bore. The bore brush, M13, is used to clean and coat the bore of the gun with oil.

(7) Extractor, elevating worm shaft. (Fig. 178, No. 4.) The extractor is used to withdraw the elevating worm shaft.

(8) Filler, oil screw. (Fig. 178, No. 5.) The oil screw filler is a high pressure hand pump. It is used to reestablish the oil reserve of the recoil and counterrecoil system when and as may be necessary in lieu of the oil pump. Its use is explained in paragraph 53 m.

### 155-MM GUN MATERIEL, M1917, M1918 AND MODIFICATIONS

(9) Gage, armature. The armature gage is used for checking the distance between the armature and the magnet of the electric brakes. Its use is indicated in paragraphs 56, 69 c (5), and 74.

(10) Gage, snap. This snap gage is for checking the length of the safety lug on the percussion hammer. The back of the percussion hammer, opposite the safety lug, has a smooth surface for use as a reference in determining the wear on this lug. If the gage will go over the hammer, with one of its faces over the safety lug and the other over the reference plane on the back of the hammer, the safety lug is too short, and the percussion hammer is unsafe for further use.

(11) Gun, lubr., pressure, screw-handle type, 8-oz. (Fig. 178, No. 6.) This lubricating gun is for the purpose of forcing lubricant under pressure into special lubrication fittings on the carriage and limber.

(12) Hose, lubr., heavy-duty, 15-inch. (Fig. 178, No. 7.) This heavy-duty lubricating hose is used with the gun, lubr., pressure, above.

(13) Lock, traveling. (Fig. 179, No. 8.) The traveling lock consists of an irregularly shaped beam with a locking screw near the center and a pinion housed at each end. It is provided to move the gun into battery, or to retract it into traveling position. For instructions as to its use, see paragraphs 37 i and 47 s.

(14) Opener, container. The container opener is a hook-shaped tool used to open the zinc gas check pad container without cutting the inclosed pad. Gas check pads are currently packed in wooden containers.

(15) Pump, oil, M2A1. (Fig. 178, No. 9.) The oil pump is provided to fill the recoil and counterrecoil systems. The pump is driven by a lever, which is fulcrumed in a bracket. In the bracket are two holes which may be utilized to increase or decrease the leverage to suit the back pressure of the pump. Secured to the pump outlet valve is a coiled copper tubing, which may be attached to the filling and drain valve of either the recoil or counterrecoil cylinder. When the pump is being filled, the oil must be strained through a clean cloth to prevent foreign matter from entering the pump reservoir.

(16) Pump, oil, M3. This pump replaces the oil pump, M2A1. It is used for the same purpose, housed in the same type of chest, and operated in the same manner, except that it is not clamped to the trails and the number of strokes per equivalent volume of oil is greater.

(17) Rammer. (Fig. 179, No. 10.) The rammer is a bronze head which is attached to a staff. When loading, the rammer is used to ram the projectile into its seat in the breech mechanism.

prim  
woo

filli  
recc

ste  
am  
rec

TL  
te  
bi

u  
c  
n  
c  
e  
i

ORGANIZATION SPARE PARTS AND ACCESSORIES

(18) Reamer, primer seat cleaning. (Fig. 178, No. 11). The primer seat cleaning reamer is composed of a bronze reamer affixed to a wooden handle. It is used to remove fouling from the primer seat.

(19) Release, filling and drain valve. (Fig. 178, No. 12.) The filling and drain valve release is used to drain the reserve oil from the recoil and counterrecoil cylinders.

(20) Rule, S., flex., 30-cm. (Fig. 178, No. 13). This flexible steel-rule, calibrated in inches and centimeters (and millimeters), has among its purposes the gaging of the reserve oil in the recoil and counter-recoil systems.

(21) Spacer, counterbalance tension rod. (Fig. 178, No. 14.) This spacer, when placed on the exposed portion of the counterbalance tension rod, is used to remove the counterbalance assembly from the breech mechanism. For instructions as to its use, see paragraph 76 b.

(22) Tray, loading. (Fig. 179, No. 15.) The loading tray is used to support the projectile when loading the gun. The tray is a concave metal trough with handles attached to the sides for lifting. At the nose of the tray, two guides are assembled which slide into the spaces cut in the breech sectors. A bronze stop, on the bottom of the tray, engages a socket in the breech ring and retains the tray in position. For illustration of use, see paragraphs 42 e and f.

(23) Wrenches. (The following letters designate parts in fig. 180.)

A Wrench, box, 77-mm. Used to adjust the elastic suspension, or to unscrew the spring suspension adjusting nut prior to dismounting the elastic suspension housing.

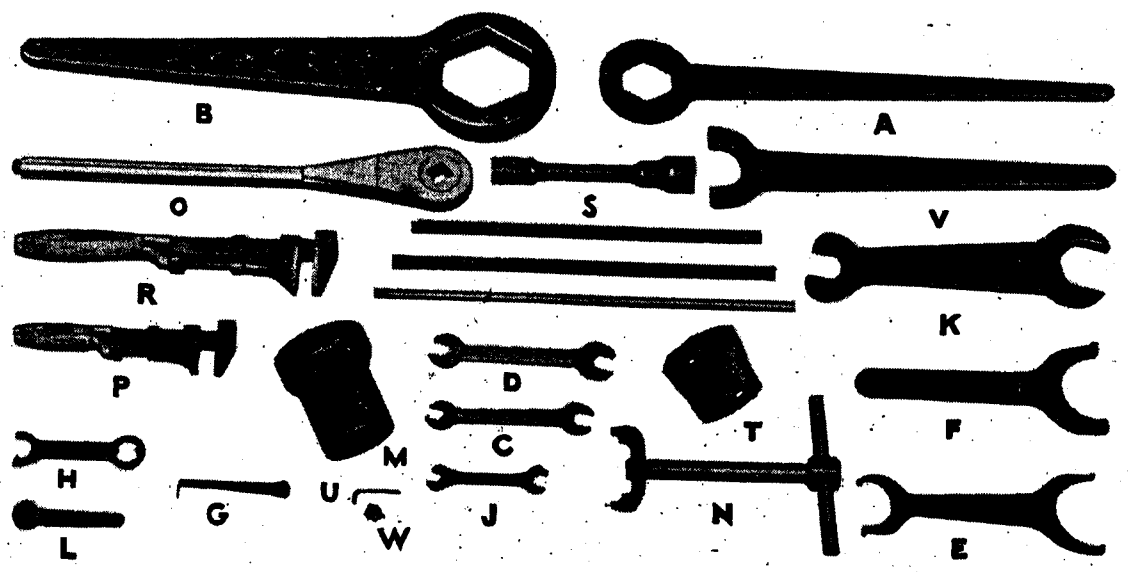

RA PD 37697

Figure 180—Wrenches required for the 155-mm gun materiel, M1917, M1918

ATIONS  
checking  
brakes.  
length of  
percussion  
use as a  
over the  
over the  
short,  
(Fig.  
bricant  
imber.  
This  
above.  
con-  
enter  
into  
its  
ped  
the  
ers.  
ro-  
by  
es  
re  
d  
of  
l,  
r

## 155-MM GUN MATERIEL, M1917, M1918 AND MODIFICATIONS

**B** Wrench, box, 130-mm. Used to tighten and adjust the trail hinge pin nuts on the undersides of the trails.

**C** Wrench, engineer's, double-head, alloy-steel,  $\frac{3}{4}$ - and  $\frac{13}{16}$ -inch. Used for various purposes.

**D** Wrench, engineer's, double-head, alloy-steel,  $\frac{15}{16}$ - and  $1\frac{1}{16}$ -inch. Used for various purposes.

**E** Wrench, face spanner, 68- and 99-mm. Used to tighten or adjust the retainers inside the piston rod nuts.

**F** Wrench, face spanner, 101-mm span. Used during disassembly of the breech mechanism to remove the obturator spindle.

**G** Wrench, firing mechanism. Used to unscrew the firing pin housing during disassembly of the firing mechanism.

**H** Wrench, fuze, M7. Used for tightening the fuze in the projectile before firing.

**J** Wrench, open, 17- and 20-mm. Used to remove oil cups from the gun or carriage, and also used on the oil extractor.

**K** Wrench, open, 49- and 77-mm. Used to remove the elevating worm shaft rear stop, and pintle bolt nut.

**L** Wrench, pin, 32-mm. Used to remove the bolt sleeves when removing the sighting gear case.

**M** Wrench, piston rod nut, with handle. Used to remove or replace the recoil and counterrecoil piston rod nuts.

**N** Wrench, pivot bolt nut. Used to remove the pivot bolt nut when disassembling the carriage.

**O** Wrench, ratchet, reversible, 24-inch handle. Used in pairs to ratchet the gun into firing or traveling position.

**P** Wrench, screw, adjustable, knife-handle, 12-inch.

**R** Wrench, screw, adjustable, knife-handle, 18-inch. Used for various purposes.

**S** Wrench, socket. Used, with handle, to remove and replace wheel stud nuts.

**T** Wrench, socket. Used, with handle, to remove and replace axle spindle nuts.

**U** Wrench, socket head set screw,  $\frac{1}{8}$ -inch hexagon. Used to loosen or tighten various set screws during disassembly and assembly of the gun. Also for authorized adjustments on sighting equipment.

**V** Wrench, trail hinge pin (face spanner, 72-mm span). Used to hold the trail hinge pin from turning while the trail hinge pin nut is being tightened or loosened.

**W** Wrench, wing teat, pin face,  $\frac{3}{8}$ -inch span, with screwdriver blade. Used for making authorized adjustments on sighting equipment.

Section XVI  
STORAGE, PACKING AND SHIPMENT

	Paragraph
Prepare for storage or shipment.....	140
Shipment by rail.....	141
Care of guns in storage.....	142
Prepare for use after storage or shipment.....	143

**140. PREPARE FOR STORAGE OR SHIPMENT**

- a. Wash the gun, carriage and limber thoroughly.
- b. Clean all unpainted surfaces of the materiel with dry cleaning solvent to remove films of moisture and other corrosive agents.
- c. Before preparing the materiel for storage or shipment, completely inspect the materiel, and repair, replace or report all broken, damaged or missing parts.
- d. Touch up painted surfaces if cracked or chipped.
- e. Protect all unpainted parts of the gun (including bore of tube and inclosed parts of the breech mechanism), carriage and limber with a film of rust preventive compound. Use heavy rust preventive compound for extended periods of storage or long shipments.
- f. Lubricate the gun, carriage and limber as prescribed in paragraph 50.
- g. Seal the barrel. After the above operations are completed, a piece of canvas or burlap should be impregnated with compound, rust-preventive, light, and placed over the muzzle of the gun and firmly tied or strapped in place. The breech also should be sealed by use of heavy grease and the breech cover and carriage covers put in place.
- h. When the gun is stored, the tires either should be removed or raised from the floor. In both cases, the tires should be wrapped with paper or other material to exclude light and moisture.
- i. Cover the gun, carriage and limber with paulins, and tie firmly or strap them in place.

**141. SHIPMENT BY RAIL**

- a. General instructions. Ship the 155-mm gun, carriage, and limber with the gun mounted and in traveling position.

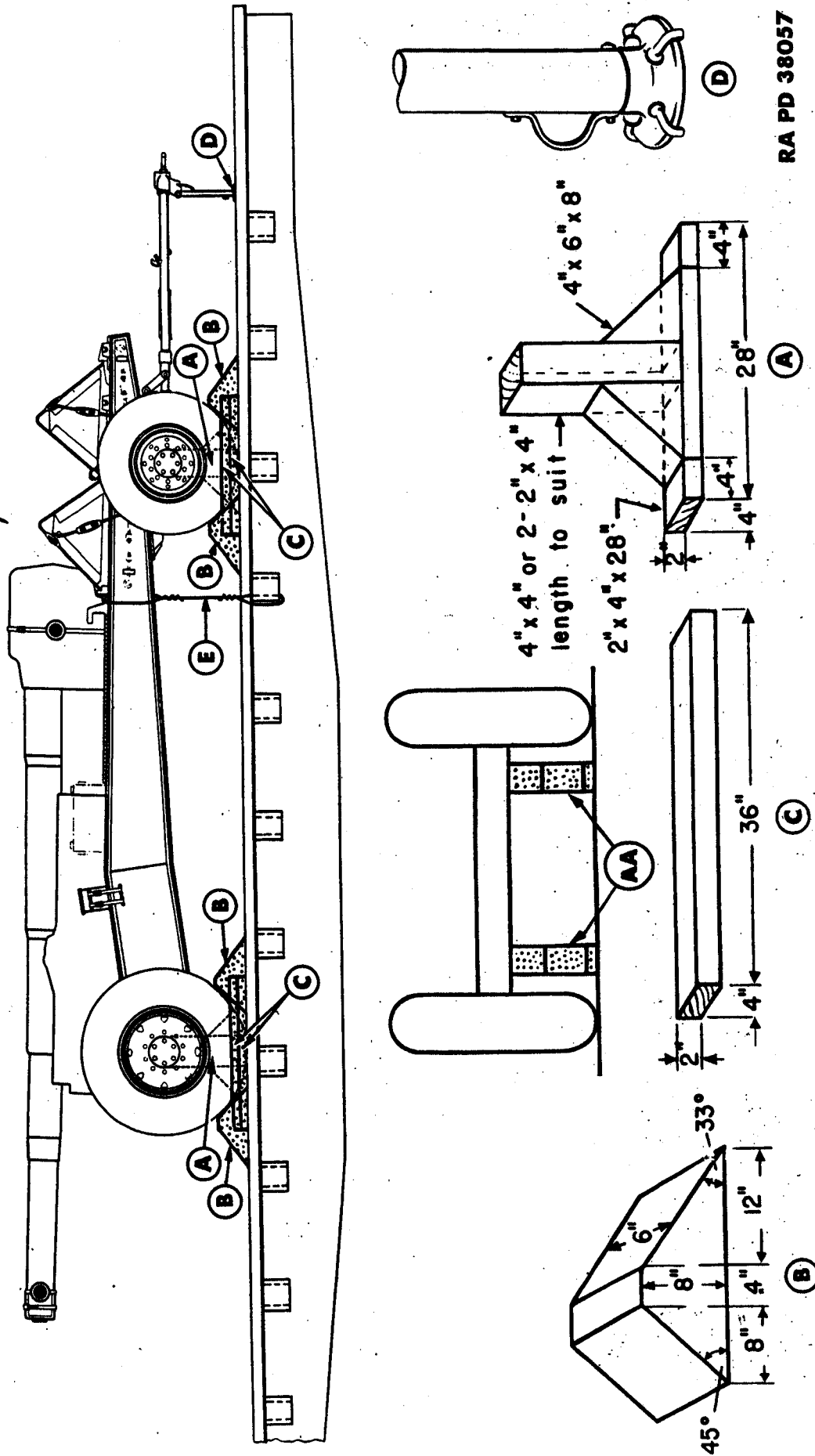

RA PD 38057

Figure 181—Method of blocking 155-mm gun, carriage and limber for shipment by rail

direct  
the  
end  
to  
ha  
an  
str  
fo  
o  
a  
c  
r  
t

### STORAGE, PACKING AND SHIPMENT

b. Preparation. Rust-proof and seal the gun and carriage as directed in paragraph 140, and put the gun in traveling position. Inflate the carriage and limber tires at least 10 pounds above the normal pressure.

c. Types of railroad cars. Shipment will be made on flat cars, end-door box cars, or double side-door box cars. Cars must be inspected to see that they are suitable for carrying the intended load. They must have good, sound floors. Remove all loose nails or other projections not an integral part of the car. Tighten loose nails and bolts used in the construction of the car.

d. Loading. Load the carriage from permanent ramps or platforms where available; improvised ramps may be built of railroad ties or other available heavy lumber when necessary. If railroad jacks are available, they may be used in loading or removing the carriage from one end of a flat car. Great care must be taken in constructing permanent ramps. Due to the weight of material, use only heavy timbers secured by bolts. See figures 182 and 183 for sketches of both permanent and temporary ramps. Further information for loading is contained in FM 101-10, chapter 2.

e. Blocking. Block and secure the carriage and limber substantially as shown in figure 181. Set the hand brakes of the carriage.

(1) Build up four sets of braces (item A., fig. 181). Place under the carriage and limber axles (AA, fig. 181) to relieve partially the weight on the tires.

(2) Block the wheels, using items B and C, figure 181.

(3) Anchor the foot of the drawbar prop to the car floor with nails as shown in D, figure 181.

(4) Secure the trails to the stake pockets of the freight car with No. 8 gage, black annealed wire (item E, fig. 181). Protect the points of contact between the trails and the wire with canvas or burlap.

f. Items and application. The following are the minimum requirements for securing a 155-mm gun, carriage and limber to a freight car for shipment by rail:

Item	Number of pieces	Description
A	4 (two for each axle)	Brace, length, 1/4-inch longer than the distance between the axle and the car floor. Jack up axle, place braces between car floor and axle, and lower axle. Purpose, to relieve partially weight on tires.
B	8 (two for each wheel)	Wheel blocks, 6- by 8- by 24-inch. Height at point of contact with tire

ATIONS

RA PD 38057

Method of blocking 155-mm gun, carriage and limber for shipment by rail

155-MM GUN MATERIEL, M1917, M1918 AND MODIFICATIONS

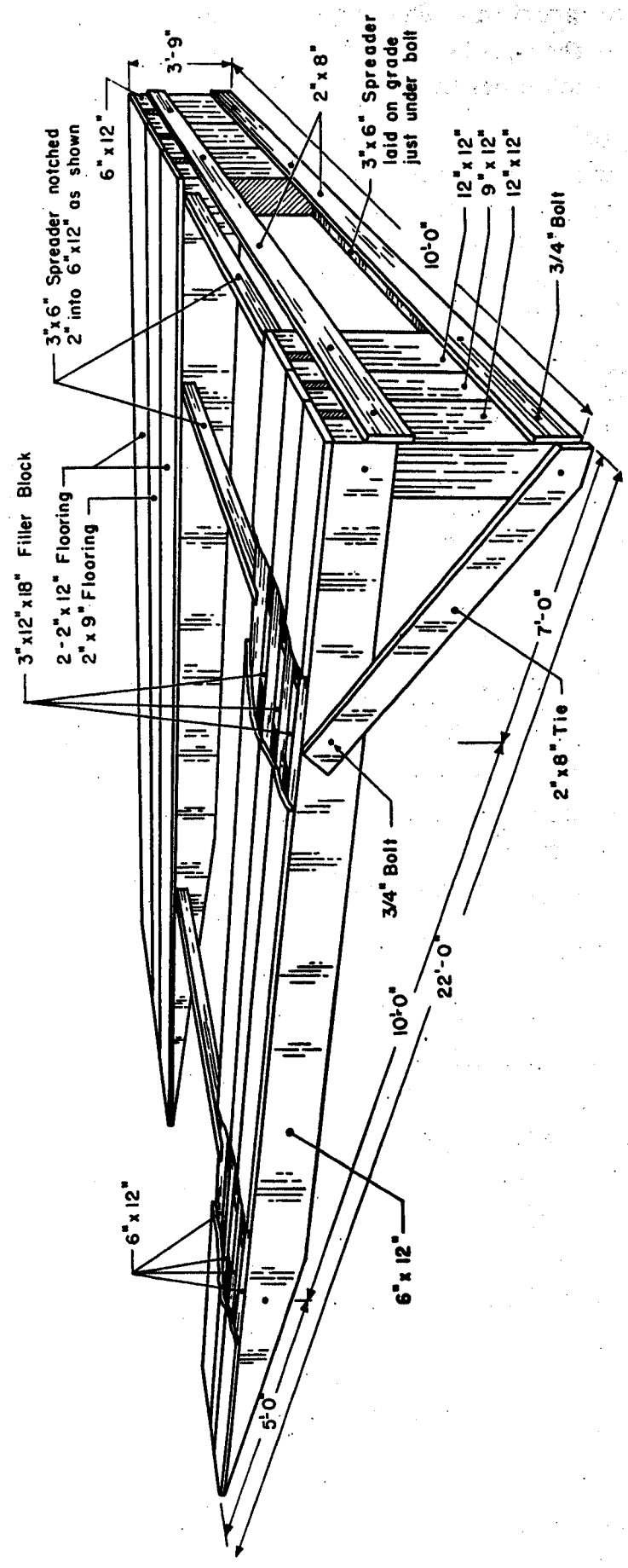

RA PD 23938

Figure 182—Permanent loading ramp—155-mm gun materiel





155-MM GUN MATERIEL, M1917, M1918 AND MODIFICATIONS

Item	Number of pieces	Description
C	8 (two each side of each wheel)	<p>must be not less than four inches from car floor. Nail heel of block to car floor with three 40d nails, and toe-nail that portion under tire to car floor with two 40d nails before items C are applied.</p> <p>Cleats, 2- by 4- by 36-inch. Nail lower piece to car floor at outside edge of tire with three 40d nails. Nail top piece to one below with three 40d nails. Cleats will be nailed lengthwise of car.</p>
D		<p>Drive four nails into car floor around foot of drawbar prop and bend nails over foot to anchor foot to car floor.</p>
E	2 (one for each trail)	<p>Tie, six strands, three wrappings, No. 8 gage, black annealed wire. Loop around gun trail and twist tie with rod or bolt. Secure to stake pockets on opposite sides of car.</p>

Ge  
Tr  
Ar  
E  
E  
1

142. CARE OF GUNS IN STORAGE

a. The condition of unpainted surfaces of materiel in storage should be inspected at frequent intervals to determine the effectiveness of the preventive measures taken to resist corrosion. The rust preventive compound should be removed from portions of the materiel, and the unpainted surfaces carefully inspected for signs of rust or corrosion. If there are signs of rust, the materiel should be cleaned with dry cleaning solvent, the rust removed, and the materiel recoated with rust preventive compound.

b. The recoil mechanism should be exercised as prescribed in paragraph 53-n, and the counterrecoil mechanism should be exercised as prescribed in paragraph 53-o.

143. PREPARE FOR USE AFTER STORAGE OR SHIPMENT

a. Clean all coated surfaces with dry cleaning solvent.

b. Lubricate the gun, carriage and limber as prescribed in paragraph 50. Particular attention should be given to the selection of the proper lubricants for the climate in which the gun is to be used.

c. Give the materiel a thorough inspection as prescribed in "Inspection and Adjustment", Section VIII. Particular attention should be given to springs (which may have taken a "set"), recoil and counterrecoil mechanisms, brakes and tires.

Section XVII

OPERATION UNDER UNUSUAL CONDITIONS

	Paragraph
General.....	144
Tropical climates.....	145
Arctic climates.....	146
Excessively moist or salty atmosphere.....	147
Excessively sandy or dusty conditions.....	148

144. GENERAL

a. Because of the different climates in which this materiel may be expected to operate, special instructions are given in this section for three regions, namely: Arctic, temperate and tropical.

b. By Arctic is meant a climate usually experienced in Alaska, Newfoundland, Labrador or Iceland. By temperate is meant a climate usually experienced in continental United States or Hawaii. By tropic is meant a climate usually experienced in Panama, the Philippines and Cuba.

c. In certain cases, the prescribed instructions may not apply; for example, a tropic climate may be experienced in a temperate region. In cases of this nature, the instructions as to the classification of climate in which the materiel is operating is left to the judgment of the ordnance officer. He is cautioned, however, that only extended, and not temporary periods, of climatic conditions govern the classification.

d. Manufacturing arsenals and plants should lubricate the materiel on assembly as prescribed in the lubrication guides (figs. 90 and 91). If the materiel is to be used in a climate other than temperate, the precautions in paragraphs 145 or 146 should be taken.

e. Materiel, previously lubricated for a colder climate than the one in which the materiel is to be used, should be relubricated with lubricants prescribed for use in that climate.

f. Materiel, previously lubricated for a warmer climate than the one in which the materiel is to be used, should be completely cleaned of all lubricants and relubricated with the lubricants prescribed for use in that climate.

145. TROPICAL CLIMATES

No definite information is available at this writing other than the usual precautions to see that in temperatures above 90 F., summer grade grease (GREASE, O.D., No. 0), and SAE 30 or SAE 50 oil are used

ICATIONS  
inches from  
to car floor  
e-nail that  
r with two  
e applied.  
Nail lower  
ge of tire  
o piece to  
ls. Cleats  
r.  
around  
nd nails  
r floor.  
gs, No.  
Loop  
ith rod  
ts on  
ould  
the  
om-  
un-  
If  
ing  
ve  
a-  
ts

### 155-MM GUN MATERIEL, M1917, M1918 AND MODIFICATIONS.

as lubricants. The tires should be checked frequently during traveling to be sure that the pressure is not deviating appreciably from the prescribed pressures. The oil quantities in the replenisher and the counter-recoil system should be checked as described in paragraph 38.

#### 146. ARCTIC CLIMATES

a. **General.** Preparing a weapon for Arctic climates consists of inspecting and placing the weapon in good mechanical condition, cleaning and lubricating with cold weather lubricants, and frequent exercising. The recoil oil should be modified by ordnance maintenance personnel.

b. **Inspection.** The materiel should be inspected to see that all moving parts operate freely and without binding. The elevating and traversing handwheels should be operated throughout their ranges. Tires should be checked frequently during traveling to see that the pressure is correct. The recoil mechanism should be checked for proper amount of oil in the replenisher and in the counterrecoil system (par. 38).

c. **Lubrication of the materiel.** The materiel should be properly lubricated in accordance with instructions in paragraph 50. Before applying the cold weather lubricants, the materiel should be thoroughly cleaned and all old lubricants removed.

d. **Sighting and fire control instruments.** Sighting and fire control instruments are normally lubricated for operation over a wide range of temperatures (including Arctic). They should be exercised frequently during periods of low temperature, to insure their proper functioning. If the instruments do not function properly, the ordnance maintenance personnel should be notified.

#### 147. EXCESSIVELY MOIST OR SALTY ATMOSPHERE

a. When the materiel is not in active use, the unpainted parts should be covered with a film of rust preventive compound. The bore of the tube and the breech mechanism should be kept heavily oiled, and should be inspected daily for traces of the formation of rust. The materiel should be kept covered with paulins firmly tied or strapped in place.

b. In excessively salty atmosphere, the oil or rust preventive compound used should be changed often as the salt has a tendency to emulsify the oil and destroy its rust preventive qualities.

#### 148. EXCESSIVELY SANDY AND DUSTY CONDITIONS

a. If considerable dust is present when the gun is operated, the lubricant should be removed from the elevating sector and worm, traversing sector and worm and the translating racks, and the teeth of these

parts  
there  
grit.

sys

of t

rou

pr

### OPERATION UNDER UNUSUAL CONDITIONS

parts should remain dry until the action is over. If the surfaces are dry, there is less wear than when coated with a lubricant contaminated with grit.

b. The breather and drain holes of the recoil and counterrecoil systems should be kept open.

c. The breech and muzzle covers must be kept on the gun as much of the time as firing conditions permit.

**NOTE:** For extreme conditions of speed, heat, water, mud, snow, rough roads and salty or moist air, lubricate more frequently than is prescribed for normal service.

ICATIONS  
ng traveling  
om the pre-  
he counter-  
  
consists of  
on, clean-  
xercising.  
sonnel.  
that all  
ing and  
es. Tires  
essure is  
ount of  
  
prop-  
Before  
oughly  
  
d fire  
wide  
fre-  
tion-  
nte-  
  
rts  
of  
id  
el

## Section XVIII

## MATERIEL AFFECTED BY GAS

	Paragraph
Protective measures.....	149
Cleaning.....	150
Decontamination.....	151

## 149. PROTECTIVE MEASURES

a. When materiel is in constant danger of gas attack, unpainted metal parts will be lightly coated with engine oil. Instruments are included among the items to be protected by oil from chemical clouds or chemical shells, but ammunition is excluded. Care will be taken that the oil does not touch the optical parts of instruments or leather or canvas fittings. Materiel not in use will be protected with covers, as far as possible. Ammunition will be kept in sealed containers.

b. Ordinary fabrics offer practically no protection against mustard gas or lewisite. Rubber and oilcloth, for example, will be penetrated within a short time. The longer the period during which they are exposed, the greater the danger of wearing these articles. Rubber boots, worn in an area contaminated with mustard gas, may offer a grave danger to men who wear them several days after the bombardment. Impermeable clothing will resist penetration more than an hour, but should not be worn longer than this.

## 150. CLEANING

a. All unpainted metal parts of materiel that have been exposed to any gas, except mustard and lewisite, must be cleaned as soon as possible with solvent, dry cleaning, or alcohol, denatured, and wiped dry. All parts should then be coated with engine oil. The using arm will decontaminate the exterior surfaces, the bore, the breechblock assembly, and all porous attachments such as straps and covers of artillery exposed to gas.

b. Ammunition which has been exposed to gas must be thoroughly cleaned before it can be fired. To clean ammunition, use agent, decontaminating, non-corrosive, or if this is not available, strong soap and cool water. After cleaning, wipe all ammunition dry with clean rags. Do not use dry powdered agent, decontaminating (chloride of lime) (used for decontaminating certain types of materiel on or near ammunition supplies), as flaming occurs through the use of chloride of lime on liquid mustard.

MATERIEL AFFECTED BY GAS

151. DECONTAMINATION

For the removal of liquid chemicals (mustard, lewisite, etc.), from materiel, the following steps should be taken:

a. Protective measures. (1) For all of these operations, a complete suit of impermeable clothing and a service gas mask will be worn. Immediately after removal of the suit, a thorough bath with soap and water (preferably hot) must be taken. If any skin areas have come in contact with the mustard, if even a very small drop of mustard gets into the eye, or if the vapor of mustard has been inhaled, it is imperative that complete first-aid measures be given within 20 or 30 minutes after exposure. First-aid instructions are given in TM 9-850 and FM 21-40.

(2) Garments exposed to mustard will be decontaminated. If the impermeable clothing has been exposed to vapor only, it may be decontaminated by hanging in the open air, preferably in sunlight for several days. It may also be cleaned by steaming for two hours. If the impermeable clothing has been contaminated with liquid mustard, steaming for six to eight hours will be required. Various kinds of steaming devices can be improvised from materiel available in the field.

b. Procedure. (1) Commence by freeing materiel of dirt through the use of sticks, rags, etc., which must be burned or buried immediately after this operation.

(2) If the surface of the materiel is coated with grease or heavy oil, this grease or oil should be removed before decontamination is begun. Solvent, dry cleaning, or other available solvents for oil should be used with rags attached to ends of sticks.

(3) Decontaminate the painted surfaces of the materiel with bleaching solution made by mixing one part agent, decontaminating (chloride of lime), with one part water. This solution should be swabbed over all surfaces. Wash off thoroughly with water, then dry and oil all surfaces.

(4) All unpainted metal parts and instruments exposed to mustard or lewisite must be decontaminated with agent, decontaminating, non-corrosive, mixed one part solid to fifteen parts solvent (acetylene tetrachloride). If this is not available, use warm water and soap. Bleaching solution must not be used, because of its corrosive action. Instrument lenses may be cleaned only with paper, lens, tissue, using a small amount of alcohol, ethyl. Coat all metal surfaces lightly with engine oil.

(5) In the event agent, decontaminating (chloride of lime), is not available, materiel may be temporarily cleaned with large volumes of hot water. However, mustard, lying in joints or in leather or canvas webbing, is not removed by this procedure and will remain a constant source of danger until the materiel can be properly decontaminated. All

Paragraph  
... 149  
... 150  
... 151

unpainted  
parts are in-  
clouds or  
that the  
or canvas  
as far as

mustard  
penetrated  
exposed,  
worn in  
danger to  
impermeable  
not be

exposed  
in as  
dry.  
con-  
and  
used

highly  
con-  
sol  
of  
e)  
ir  
e

**155-MM GUN MATERIEL, M1917, M1918 AND MODIFICATIONS**

mustard washed from materiel in this manner lies unchanged on the ground, necessitating that the contaminated area be plainly marked with warning signs before abandonment.

(6) The cleaning or decontaminating of materiel contaminated with lewisite will wash arsenic compounds into the soil, poisoning water supplies in the locality for either men or animals.

(7) Leather or canvas webbing, that has been contaminated, should be scrubbed thoroughly with bleaching solution. In the event this treatment is insufficient, it may be necessary to burn or bury such materiel.

(8) Detailed information on decontamination is contained in FM 21-40, TM 9-850, and TC 38, 1941, Decontamination.



Section XIX  
REFERENCES

152. STANDARD NOMENCLATURE LISTS

- a. **Ammunition.**
  - Ammunition instruction material, for harbor defense, heavy field, and railway artillery . . . SNL P-7
  - Charges, propelling, separate loading, for harbor defense, heavy field, and railway artillery . . . SNL P-3
  - Fuzes, primers, blank ammunition, and miscellaneous items for harbor defense, heavy field, and railway artillery . . . SNL P-6
  - Projectiles, separate loading, for harbor defense, heavy field, and railway artillery . . . SNL P-1
- b. **Cleaning, preserving, and lubricating materials.** . . . SNL K-1
- c. **Firing tables.** . . . SNL F-69
- d. **Gun materiel.**
  - Gun, 155-mm, M1917, M1918MI, and carriage, 155-mm gun, M1917 and M1918 . . . SNL D-11
  - Gun, 155-mm, M1917 and M1918MI, and carriages, 155-mm gun, M1917A1, M2, M1918A1 and M3 . . . SNL D-30
  - Major items of heavy field artillery . . . SNL D-1
- e. **Sighting and fire control materiel.**
  - Circle, aiming, M1 . . . SNL F-160
  - Finder, range, horizontal base, 9-foot . . . SNL F-88
  - Finder, range, horizontal base, 15-foot . . . SNL F-105
  - Harbor defense, railway and antiaircraft artillery sighting equipment and fire control instruments . . . SNL F-2
  - Instrument, azimuth, M1910A1 (degrees) . . . SNL F-84
  - Instrument, azimuth, M1918 . . . SNL F-149
  - Instrument lights . . . SNL F-205
  - Mount, telescope, M4 . . . SNL F-142
  - Mount, telescope, M6 (mils), and M6A1 (mils) (for 155-mm gun, M1918) . . . SNL F-156
  - Quadrant, gunner's, M1 (mils) . . . SNL F-140
  - Quadrant, gunner's, M1918 (mils) . . . SNL F-13
  - Setter, fuze, hand, M1913 . . . SNL F-127
  - Sight, quadrant, M1918 . . . SNL F-24
  - Small arms, automatic gun, trench mortar and field artillery sighting equipment and fire control instruments . . . SNL F-1

ATIONS  
ed on the  
arked with  
  
aminated  
ing water  
  
d, should  
is treat-  
materiel.  
ined in

155-MM GUN MATERIEL, M1917, M1918 AND MODIFICATIONS

Telescope, 2-in., M1909A1 (for 155-mm gun, M1918).....	SNL F-172
Telescope, B. C., M1915A1.....	SNL F-9
Telescope, panoramic, M8.....	SNL F-196
Telescope, panoramic, M2A1 (mils); telescope, panoramic, M3A1 (degrees); telescope, panoramic, M4 (mils); telescope, panoramic, M6 (mils).....	SNL F-22
Current Standard Nomenclature Lists are as tabulated here. An up-to-date list of SNL's is maintained as the "Ordnance Publications for Supply Index".....	OPSI

153. EXPLANATORY PUBLICATIONS

- a. Cleaning, preserving and lubricating materials. TM 9-850
- b. Fire control materiel.
  - Field Artillery fire-control instruments..... TM 6-220
  - Fire control and position finding..... FM 4-15
  - Instruction guide, telescope mount, M6A1, and panoramic telescope, M8..... TM 9-2554
  - Instruction guide, azimuth instrument, M1918A2..... TM 9-2680
  - Instruction guide—telescope mount, M20; panoramic telescope, M8, and elevation quadrant, M1..... TM 9-2674
- c. Gun and carriage.
  - Coast artillery weapons and materiel..... TM 4-210
  - Coast Artillery Field Manual, Seacoast Artillery: Gunnery..... FM 4-10
  - Service of the piece, 155-mm gun..... FM 4-25
  - Service of the piece, 155-mm gun, M1918..... FM 6-85
- d. Maintenance and repair.
  - Chemical decontamination materials and equipment..... TM 3-220
  - Defense against chemical attack..... FM 21-40
  - Preservation and care of seacoast defense materiel..... TM 4-245
- e. Miscellaneous.
  - Artillery gun book..... O. O. Form 5825

REFERENCES

154. FIRING TABLES

- a. Gun, 155-mm, M1917, M1917A1, M1918MI:
  - Shell, HE, Mk. III, fuze, PD, M46, M47; shell, chemical, Mk. VII; and shell, empty, for sand loading, 95-lb..... FT 155-B-5
  - Shrapnel, Mk. I, 155-mm..... FT 155-C-2
  - Shell, HE, Mk. 101, and shell, HE, Mk. IIIA1. FT 155-U-1
  - Shell, HE, Mk. III, fuze, PD, M46, M47, charge normal..... TD 155-B-4a
  - Shell, HE, Mk. III, fuze, PD, M46, M47, charge super..... TD 155-B-4b
  - Shell, chemical, M104..... FT 155-U-1
  - Projectile, A.P., M112..... FT 155-W-1
  - Shell, chemical, VIIA1 ..... FT 155-U-1
  
- b. Gun, 37-mm, M1916:
  - Shell, practice, Mk. II..... FT 37-O-1

Current firing tables are as tabulated here. An up-to-date list of firing tables is maintained in SNL F-69

CATIONS

L F-172  
L F-9  
F-196

F-22

50

0

4

)

# 155-MM GUN MATERIEL, M1917, M1918 AND MODIFICATIONS

## INDEX

<b>A</b>		Page No.			Page No.
Accessories .....	221		Battery commander's (BC) tele-		
care and preservation.....	80		scope, M1915A1 .....	179	
Accidents, field report of.....	203		Beam, jack .....	221	
Action, to prepare for.....	69		Bearings, wheel, to adjust.....	94	
Aiming circle, M1.....	163		Bit, vent cleaning.....	223	
Aiming post, M1.....	155		Blocking for rail shipment.....	228	
Aiming post light, M14.....	155		Book, artillery gun.....	223	
Air brakes .....	40		Bore sight .....	160	
adjustment .....	97		Bore sighting .....	153	
care and preservation.....	96		subcaliber .....	214	
functioning .....	43		Bottom carriage .....	36	
inspection .....	111		Brake chambers .....	45	
malfunction and correction.....	119		Brake mechanism .....	43	
Air hose .....	55		Brakes:		
to replace .....	97		air brakes .....	40	
Air relief valve.....	32		care and preservation.....	96	
Ammeter .....	221		malfunction and correction....	119	
Ammunition .....	183		to adjust .....	97	
authorized rounds .....	187		electric brakes .....	46	
care, handling and preservation..	186		care and preservation.....	98	
classification .....	184		malfunction and correction....	119	
field reports of accidents.....	204		hand brakes .....	47	
firing tables .....	184		mechanical brakes .....	47	
fuzes .....	197		care and preservation.....	99	
identification and marking.....	184		lubrication .....	99	
marking .....	184		to adjust .....	99	
nomenclature .....	184		Breech mechanism .....	23	
packing .....	203		assembly .....	125	
preparation for firing.....	190		care and preservation.....	87	
primers .....	202		disassembly .....	122	
projectiles .....	190		Breech ring .....	13	
propelling charges .....	195		Breechblock .....	15	
Arctic climates .....	234		assembly .....	125	
Authorized rounds .....	187		disassembly .....	123	
table of authorized rounds.....	188		Breechblock carrier .....	16	
Assembly:			Brush, bore .....	223	
breech mechanism .....	125		Brushes, care of.....	103	
counterbalance regulating screw..	133				
elastic suspension .....	135		<b>C</b>		
firing mechanism .....	132		Camouflage .....	105	
operating lever .....	130		Care, handling and preservation,		
percussion mechanism .....	131		ammunition .....	186	
wheels .....	137		Care and preservation.....	79	
Axle, carriage .....	36		air brakes .....	96	
Axle, limber .....	49		bearings, wheel .....	94	
<b>B</b>			breech mechanism .....	87	
Band, caterpillar .....	221		carriage and limber.....	93	
Barrel assembly .....	13		cleaners and abrasives.....	100	
care and preservation.....	86		electric brakes .....	98	
Battery, to place in.....	59		lubrication .....	80	
			materials and tools.....	103	



155-MM GUN MATERIEL, M1917, M1918 AND MODIFICATIONS

INDEX

F—Cont'd		Page No.	H		Page No.
compass, M2 .....		169	Hose, lubr., heavy duty.....		224
graphical firing tables.....		177	Hubs .....		55
hand fuze setter, M1913.....		177	to adjust .....		94
prismatic compass, M1918 (Sperry) .....		167	<b>I</b>		
Firing mechanism .....		18	Identification, ammunition .....		184
assembly .....		132	Inspection .....		108
care and preservation.....		87	carriage .....		109
disassembly .....		131	gun .....		108
Firing position, to place in.....		59	limber .....		112
Firing tables .....		241	serial numbers .....		107
Firing tables, graphical .....		177	subcaliber .....		214
Fuze setter, hand, M1913.....		177	visual .....		107
Fuzes .....		197	Introduction .....		3
<b>G</b>			<b>L</b>		
Gage, armature .....		224	Leveling plates .....		14
snap .....		224	Limber, M3 .....		49
Gas, materiel affected by.....		236	air hose .....		55
cleaning .....		236	axle .....		49
decontamination .....		237	care and preservation.....		93
protective measures .....		236	characteristics .....		5
Graphical firing tables.....		177	data .....		9-10
Guard, brush .....		52	differences .....		5
Gun, lubricating .....		224	drawbar .....		53
Guns .....		11	fifth-wheel .....		51
barrel assembly .....		13	inspection .....		112
breech mechanism functioning ..		23	lubrication .....		83
breechblock .....		15	springs .....		51
breechblock carrier .....		16	trails, to attach.....		58
care and preservation.....		79	wheels, tires and hubs.....		55
characteristics .....		3	Limber, M1917 and M1918.....		56
counterbalance mechanism .....		22	Limber, M1917A1 and M1918A1... ..		58
data .....		7	Lime, hydrated .....		101
differences .....		25	Load (to load).....		70
firing mechanism .....		18	Lock pin, drawbar.....		54
inspection .....		108	fifth-wheel .....		52
lubrication .....		83	Lock, traveling .....		224
malfunction and correction.....		116	Lubrication .....		80
obturator .....		117	chart, carriage .....		82
to elevate .....		68	chart, gun .....		81
to fire .....		74	M1917, M1918, M1917A1, M1918A1 .....		84
to load .....		70	subcaliber .....		219
to place in battery.....		59	Lunette, limber, M3.....		54
to place in traveling position....		75	<b>M</b>		
to prepare for action.....		69	Malfunction and adjustment .....		114
to traverse .....		67	air brakes .....		119
to unload .....		74	carriage .....		116
			electric brakes .....		119

ATIONS

INDEX

Page No.  
 ..... 224  
 ..... 55  
 ..... 94  
  
 ..... 184  
 ..... 108  
 ..... 109  
 ..... 108  
 ..... 112  
 ..... 107  
 ..... 214  
 ..... 107  
 ..... 3  
  
 ... 14  
 ... 49  
 ... 55  
 .. 49  
 .. 93  
 .. 5  
 .. 9-10  
 .. 5  
 .. 53  
 .. 51  
 . 112  
 . 83  
 51  
 58  
 55  
 56  
 58  
 101  
 70  
 54  
 52  
 224  
 80  
 82  
 81  
  
 34  
 9  
 4

M—Cont'd		Page No.
gun .....		116
misfire .....		114
recoil system .....		116
subcaliber .....		215
Mechanical brakes .....		47
care and preservation .....		99
lubrication .....		99
to adjust .....		99
Miscellaneous materials and tools ..		103
Misfire .....		114
<b>N</b>		
Naphthalene, flake .....		103
Nomenclature, ammunition .....		184
Numbers, serial .....		107
<b>O</b>		
Oblique spindles, removal and replacement .....		133
Obturator .....		17
Opener, container .....		224
Operating lever .....		16
assembly .....		130
disassembly .....		129
Operation, gun, carriage, and limber		59
to adjust counterbalance .....		75
to check liquid in recoil system ..		66
to elevate .....		68
to fire .....		74
to load .....		70
to place in battery .....		59
to place in traveling position .....		75
to prepare for action .....		69
to remove fuze from shell .....		75
to traverse .....		67
to unload .....		74
under unusual conditions .....		233
arctic climates .....		234
moist or salty atmosphere .....		234
sandy or dusty conditions .....		234
tropical climates .....		233
Operation, subcaliber .....		209
Organization spare parts .....		221
<b>P</b>		
Packing, ammunition .....		203
Painting .....		104
camouflage .....		105
lubricating devices .....		106
metal surfaces .....		105
preparing for .....		104
removing paint .....		106
Panoramic telescope, M6 .....		147

	Page No.
extension, 14-inch .....	151
Paper, flint .....	101
lens, tissue .....	101
Percussion mechanism .....	21
assembly .....	131
disassembly .....	130
Pin, lock, drawbar .....	54
fifth-wheel .....	52
Polish, metal paste .....	101
Preparation for firing .....	190
Preservatives .....	102
Primers .....	202
failure of .....	114
Projectiles .....	190
characteristics of .....	192-193
Propelling charges .....	195
failure of .....	115
Pump, oil .....	224
<b>Q</b>	
Quadrant, gunner's, M1 .....	156
Quadrant, gunner's, M1918 .....	158
Quadrant sight, M1918 .....	147
<b>R</b>	
Rail shipment .....	227
Rammer .....	224
Ramp, permanent .....	230
temporary .....	231
Reamer .....	225
Recoil, to measure length of .....	89
Recoil mechanism .....	27
care and preservation .....	88
lubrication .....	83
to fill .....	90
to gage .....	66
Recoil pointer .....	30
Recuperator .....	31
References .....	239
Relay-emergency valve .....	44
Release, filling and draining valve ..	225
Remover, paint and varnish .....	101
Replenisher .....	28
to test operation of .....	89
Report of accidents .....	203
Rule, S., flex., 30-cm .....	225
<b>S</b>	
Seacoast emplacement .....	48
Serial numbers .....	107
Sight, bore .....	160
Sighting, bore .....	153
subcaliber .....	214

# 155-MM GUN MATERIEL, M1917, M1918 AND MODIFICATIONS

## INDEX

S—Cont'd		Page No.	Page No.
Sighting equipment .....	144	practices to be avoided.....	218
aiming post, M1.....	155	precautions .....	218
aiming post light, M14.....	155	spare parts and accessories .....	220
bore sight .....	160	<b>T</b>	
care and preservation.....	144	Tabulated data .....	7
gunner's quadrant, M1.....	156	Target, testing .....	160
gunner's quadrant, M1918.....	158	Telescope, panoramic, M6.....	149
quadrant sight, M1918;		battery commander's M1915A1..	179
panoramic telescope, M6.....	147	Tires .....	39
testing target .....	160	care and preservation.....	93
Soap, saddle .....	102	to install .....	141
Soda, ash (sodium carbonate).....	102	to remove .....	140
Soda, caustic (lye).....	102	Top carriage .....	33
Spacer, counterbalance tension rod.	225	Trails .....	38
Spades .....	38	to attach to limber.....	58
Spare parts and accessories.....	221	Translating racks .....	39
subcaliber .....	220	Transom, spade clamping.....	39
Sponges .....	102	Traveling position, to place in.....	75
Springs, limber, M3 .....	51	Traversing mechanism .....	33
Standard Nomenclature Lists.....	239	to traverse .....	67
Storage, packing and shipment.....	227	Tray, loading .....	225
preparing for use after.....	232	Tropical climates .....	233
Subcaliber equipment .....	205	Tube .....	7
ammunition .....	220	care and preservation.....	86
bore sighting .....	214	<b>U</b>	
care and preservation.....	217	Unload (to unload) .....	74
description, breech .....	205	<b>V</b>	
mount .....	209	Visual inspection on receipt.....	107
recoil mechanism .....	207	<b>W</b>	
disassembly and assembly, gun..	211	Waste, cotton, white .....	102
gun from cradle.....	213	Wheels, carriage .....	39
mount .....	213	disassembly and assembly.....	137
inspection .....	214	limber .....	55
lubrication .....	219	Wrenches .....	225
malfunction and correction.....	215		
operation .....	209		

(A.G. 062.11 (8-14-42).)

By order of the Secretary of War:

OFFICIAL:

J. A. ULIO,  
Major General,  
The Adjutant General.

G. C. MARSHALL,  
Chief of Staff.

DISTRIBUTION:

IB (4)3; B 6(2); IR 4 and 6(3); R 9(1); IBn 4 and 6(3), 9(2);  
IC 4(6), 6(12), 9(4).

(For explanation of symbols, see FM 21-6.)